



ELAC Nautik

# NAVIGATION ECHO SOUNDER

## LAZ 5100 / ES 5100

### Technical Manual

### TH 52 603 8001 EN



Original instructions

Store safely for subsequent use!

EN



**L-3 Communications ELAC Nautik GmbH** manufactures state-of-the-art quality products.

In order to ensure the intended, correct and successful use of the products manufactured by **L-3 Communications ELAC Nautik GmbH** throughout the entire service life of the product, certain information and knowledge is necessary in corresponding phases of the product life, as described in this document.

The content of the document is indicated by the title specified (e.g. operating instructions, conversion instructions etc.).

The information is provided in a succinct, clear format.

The chapters are organised by numbers. Each chapter has its own page numbering.

The page designation consists of chapter designation and page number.

Example: Page 1-8 is the eighth page of chapter 1.

## Manufacturer:



### **L-3 Communications ELAC Nautik GmbH**

Manufacturer code: D 1876

Neufeldtstrasse 10  
24118 Kiel  
Germany

#### **Contact:**

☎: ++49 (0)431 883-0  
☎: ++49 (0)431 883-496  
@: elac.marketing@l-3com.com

#### **Technical support (Service Centre):**

☎: ++49 (0)431 883-388  
☎: ++49 (0)431 883-366  
@: elac.support@l-3com.com

The reproduction, distribution and utilisation of this document as well as the communication of its contents to others without explicit authorisation is prohibited. Offenders will be held liable for the payment of damages. All rights reserved in the event of a patent, utility model or design.

© 2014 by L-3 Communications ELAC Nautik GmbH, Neufeldtstrasse 10, D-24118 Kiel.

**Documentation Specifications**

**Upon publication of the present revised version, all previous editions become invalid.**

Designation	Details/Data	Description
Documentation number	TH 52 603 8001 EN	
Publication date	01/2014	Month/Year
Edition	Rev. P	Current revision status of the documentation. Upon publication of the present revised version, all previous editions become invalid.
Components/Chapter	Chapter 1: GENERAL INFORMATION	
	Chapter 2: GENERAL INSTALLATION INSTRUCTION FOR ECHO SOUNDERS	
	Chapter 3: TECHNICAL DESCRIPTION	
	Chapter 4: OPERATING INSTRUCTIONS	
	Chapter 5: INSTALLATION, CARE AND MAINTENANCE	
	Chapter 6: DRAWINGS	
	Chapter 7: APPENDIX	

### List of Changes and Supplements

Revision	Content	Page(s)	Changed by	Date
L	Name changed to LAZ 5100 / ES 5100. Appendix with documents for LAZ 5100 and ES 5100	Cover and chapter 7	L3 ELAC NAUTIK	02/2011
M	Interface designation changed	3-12	GR	02/2012
N	Supply voltage changed	3-6	GR	04/2012
O	Certificates in the appendix deleted / replaced by EC-Declaration of Conformity	7-4 ff.	GR	09/2012
P	Cable installation information modified	2-3, 5-2	FA	01/2014

### List of Abbreviations

Abbreviations	Meaning/Function (GB)	Meaning/Function (DE)
DIN	German Institute for Standardization	<b>D</b> eutsches Institut für <b>N</b> ormung
ISO	<b>I</b> nternational <b>S</b> tandards <b>O</b> rganisation	Internationale Organisation für Normung
IMO	<b>I</b> nternational <b>M</b> aritime <b>O</b> rganization	Internationale Seeschiffahrts-Organisation
BSH		<b>B</b> undesamt für <b>S</b> eeschiffahrt und <b>H</b> ydrographie
LAZ		<b>L</b> otanzeigegerät
ES	<b>E</b> cho <b>S</b> ounder	

\*The letters on which the acronyms are based are printed in "bold" type in the corresponding „original language“.



TABLE OF CONTENTS

<b>1</b>	<b>GENERAL INFORMATION.....</b>	<b>1-1</b>
1.1	Purpose of the Document.....	1-1
1.2	Target Audience / Personnel Qualifications.....	1-1
1.2.1	Target Audience.....	1-1
1.2.2	Personnel Qualifications.....	1-1
1.3	Representational Conventions.....	1-2
1.3.1	Symbols and Notes.....	1-2
1.3.1.1	Examples for Symbols and Instructions.....	1-2
1.4	Safety.....	1-4
1.4.1	General.....	1-4
1.4.2	Modifications and Alterations.....	1-4
1.4.3	Regulations, Directives and Standards.....	1-4
1.5	Obligations of the Personnel.....	1-5
1.6	Obligations of the Operator.....	1-5
1.7	Requirements for the Workplace.....	1-6
1.8	Replacement Parts.....	1-6
<b>2</b>	<b>GENERAL INSTALLATION INSTRUCTION FOR ECHO SOUNDERS.....</b>	<b>2-1</b>
2.1	General Remark to Hydro Acoustic Equipment.....	2-1
2.2	Transducer Installation.....	2-1
2.2.1	Cable Length, Operating Frequency.....	2-2
2.2.2	Cabling, Cable Location, Cable Specification.....	2-3
2.2.3	Transducer Cable Specification.....	2-4
2.2.4	Interfaces.....	2-4
2.2.5	Installation Checkout (Installation Report / Service Request).....	2-5
2.2.5.1	Installation Report.....	2-5
2.2.5.2	Service Request.....	2-5
2.2.5.3	ELAC Nautik Service Centre.....	2-5
<b>3</b>	<b>TECHNICAL DESCRIPTION.....</b>	<b>3-1</b>
3.1	General.....	3-1
3.1.1	Electromagnetic Compatibility.....	3-1
3.2	System Configuration.....	3-2
3.2.1	System Overview (with Options).....	3-2
3.2.2	Display and Control Unit.....	3-3
3.2.3	Transducer Connection Box.....	3-3
3.2.4	Transducer.....	3-3
3.3	Optional Equipment.....	3-4
3.3.1	Digital Slave Display(s).....	3-4
3.3.2	Printer.....	3-4
3.3.3	Optional Connection Box.....	3-4
3.3.4	Transducer Options.....	3-5
3.3.5	Switch Box.....	3-5
3.4	Technical Data.....	3-6
3.5	Interfaces.....	3-7
3.5.1	Description of NMEA Interfaces.....	3-8
3.5.1.1	NMEA-Interface X4.....	3-8
3.5.1.2	NMEA-Interface X8.....	3-9
3.5.2	Description of the other Interfaces.....	3-11
3.5.2.1	Interface X5.....	3-11
3.5.2.2	Interface X6.....	3-11
3.5.2.3	Interface X7.....	3-11
3.5.2.4	Interface X38.....	3-11
3.5.3	Pin Connections.....	3-12

<b>4</b>	<b>OPERATING INSTRUCTIONS .....</b>	<b>4-1</b>
4.1	Switching the System On/Off.....	4-1
4.2	Brief Explanation of Control Keys .....	4-2
4.3	Display Area.....	4-3
4.3.1	Single Channel Display .....	4-3
4.3.2	Two Channel Display .....	4-5
4.3.2.1	Warning Fields .....	4-5
4.4	Altering System Parameters and Settings .....	4-6
4.4.1	GAIN, RANGE and DIM Settings.....	4-6
4.4.1.1	GAIN Settings .....	4-6
4.4.1.2	RANGE Settings .....	4-7
4.4.1.3	DIM Settings.....	4-7
4.4.2	General Information Regarding Menus.....	4-8
4.4.3	Altering System Settings/Parameters within a Menu .....	4-9
4.5	Menu Description .....	4-14
4.5.1	The ALARM Menu.....	4-14
4.5.1.1	NAV-Defaults .....	4-15
4.5.1.2	Maximum and Minimum Depth Alarms .....	4-15
4.5.2	The PARAMETER Menu .....	4-16
4.5.2.1	Channel Select.....	4-16
4.5.2.2	Sound Velocity .....	4-17
4.5.2.3	Units.....	4-17
4.5.2.4	Depth Mode.....	4-18
4.5.2.5	Manual Gain Setting.....	4-18
4.5.3	The LOG DATA Menu .....	4-19
4.5.3.1	To View Stored Data .....	4-20
4.5.3.2	Explanation of Controls for Viewing Stored Data .....	4-21
4.5.3.3	Scrolling through Memory Data .....	4-22
4.5.3.4	Printing Data from the Memory.....	4-23
4.5.3.5	Fault Conditions during Print .....	4-23
4.5.3.6	Making a Hard Copy of the Screen Data .....	4-23
4.5.4	The SYSTEM-SETUP Menu .....	4-24
4.5.4.1	Changing the Date and Time.....	4-25
4.5.4.2	Color Bar Menu .....	4-26
<b>5</b>	<b>INSTALLATION, CARE AND MAINTENANCE .....</b>	<b>5-1</b>
5.1	Installation.....	5-1
5.1.1	Transducer – Cable Connection.....	5-3
5.1.2	Distortion Level Test.....	5-4
5.1.3	Transducer Types .....	5-5
5.1.4	Initial System Set-Up.....	5-6
5.1.5	Power Adjust.....	5-13
5.2	Care and Maintenance .....	5-14
<b>6</b>	<b>DRAWINGS .....</b>	<b>6-1</b>
<b>7</b>	<b>APPENDIX.....</b>	<b>7-1</b>
7.1	Installation – Report .....	7-1
7.2	Service–Anforderung / Service Request.....	7-2
7.3	Certificates .....	7-4



GENERAL INFORMATION

**1 GENERAL INFORMATION**

**1.1 Purpose of the Document**

The purpose of the present *Technical Manual* is to provide details, explanations and descriptions for the operation and installation of the Navigation Echo Sounder LAZ 5100 / ES 5100.



**The navigation echo sounders LAZ 5100 and ES 5100 are identical. The only difference lies in the name.**

**→ For simplification the term navigation echo sounder or echo sounder is used in this manual for both versions, when an explicit distinction is not required.**

**1.2 Target Audience / Personnel Qualifications**

**1.2.1 Target Audience**

The present installation instructions are directed to the following target audience:

- Operator / User of the Navigation Echo Sounder
- Specialist personnel for transducer installation

**1.2.2 Personnel Qualifications**

The following list defines the necessary qualifications for the respective activities to be performed:

Maintenance Level / Designation	Qualification
Expert / Specialist personnel	Expert/specialist personnel is defined as any person whose technical training and experience equip them with sufficient knowledge regarding the work to be performed, and who are sufficiently familiar with the relevant national working safety regulations, accident prevention regulations and generally recognised rules of technology enabling them to evaluate the safe working state of the products described herein.

Tab. 1: Personnel Qualifications

## 1.3 Representational Conventions

### 1.3.1 Symbols and Notes

The following section provides examples regarding the nature and design of symbols and (safety) instructions used in this documentation.

#### 1.3.1.1 Examples for Symbols and Instructions



Denotes general instructions and explanations.



Refers to other equally applicable documents, instructions or similar.



Refers to more advanced documentation (e.g. informative literature or third-party documentation).



Denotes a special tool, special equipment or similar required for the job in question.



Denotes potential material or tangible damage.



#### **CAUTION!**

Denotes a potentially dangerous situation!  
Unless avoiding action is taken, this could result in light or minor injuries.



#### **WARNING!**

Denotes a potentially dangerous situation!  
Unless avoiding action is taken, resulting injuries could be most severe or even fatal.



#### **DANGER!**

Denotes an immediate danger!  
Unless immediate avoiding action is taken, resulting injuries could be most severe (permanent disabilities) or even fatal.



**WARNING!**

Denotes dangerous electric voltage.



**WARNING!**

Denotes components posing an electrostatic hazard.



**WARNING!**

Denotes hot surfaces.



**WARNING!**

Denotes a potential environmental hazard.

## 1.4 Safety

### 1.4.1 General

Products by L-3 Communications ELAC Nautik GmbH have been developed and manufactured in accordance to state of the art and the recognised technical safety regulations, and ensure a high operating reliability.

Nevertheless, improper use or other use than the intended one can result in danger to life and limb for the user or third parties or to impairments of the system or of other property.



#### **DANGER!**

**Improper use or other use than the intended one impairs operating reliability!  
Danger to life and limb!**

→ **Only operate safe products in accordance with their intended use and in perfect technical serviceability.**

→ **Faults that could impair safety must be corrected immediately!**

Every person who is occupied with the use or handling of any of the products described must have read and understood the documentation. Any questions arising must have been resolved with the supervisor responsible or with the manufacturer of the product before work commences.

The notes and explanations to be found in the individual chapters of the documentation must always be complied with.

### 1.4.2 Modifications and Alterations



**Improper modifications and alterations can cause damage to the system!**

→ **Unilateral modifications and alterations are not permitted and exclude any liability on the part of the manufacturer!**

### 1.4.3 Regulations, Directives and Standards

A basic prerequisite for the proper and safe use and fault-free operation of this product is knowledge of the fundamental safety notes and of the safety regulations.

In addition to this document and the mandatory national and company-specific safety and accident prevention regulations applicable at the point of use, the recognised technical regulations must also be complied with. Attention must also be paid to other special features at the point of use.

## 1.5 Obligations of the Personnel



### CAUTION!

**Hazard to working safety!**

**Improper operation can endanger working safety!**

**→ Installation measures must only be carried out by appropriately trained personnel!**

All personnel who perform work on or with the system as described in this documentation shall undertake, before any work begins:

- to comply with the fundamental regulations regarding working safety and accident prevention,
- to have read and understood the associated documentation and the safety and warning notes it contains.

The personnel must have the corresponding qualifications (see chapter 1.2.2) for the work to be performed.



**Any questions arising must be resolved immediately in conjunction with the responsible supervisor or the manufacturer of the system!**

## 1.6 Obligations of the Operator

The operator undertakes to employ only such personnel for tasks on or with the system who

- are authorised for this work in accordance with the directives and regulations applicable at the location where the system will be used,
- are in possession of the appropriate approvals,
- are familiar with the fundamental regulations on working safety and accident prevention, and trained in the handling of the system,
- have read and understood the present documentation and the safety and warning notes contained in it, and any further applicable documents such as dimensional drawings and the connection plan.



**The fields of responsibility, authority and monitoring of personnel must be precisely determined by the operator!**

## 1.7 Requirements for the Workplace

In addition to the mandatory national and company-specific regulations, safety and accident prevention regulations and recognised technical regulations applicable at the point of use, the following requirements for the workplace must be observed:

- Keep the workplace clean and tidy at all times.
  - Remove packing material and waste immediately.
  - Keep the workplace free from oil and grease.
- When working on components with an electrostatic hazard, such work must be carried out at an ESD workplace which is equipped in accordance with the applicable regulations.
- Personal protective equipment must be used in accordance with the applicable regulations.
- Before use, check hoists and lifting gear for:
  - permissible load,
  - any damage.
- Only use material and tools that are in a faultless condition,
- Ensure that the following conditions are met:
  - stable installation facility at an appropriate working height,
  - required tools and measuring devices are available and ready for use,
  - all required material for the proper performance of the work is available and ready for use.

## 1.8 Replacement Parts



**Replacement parts must correspond to the technical requirements specified by the manufacturer.**

**This is only guaranteed in the case of original replacement parts.**



**Work (e.g. installation work) on or with the system must only be carried out by authorised specialist personnel!**

Liability is categorically rejected for the following faults:

- Damage resulting from the selection and use of impermissible or incorrect replacement or reserve parts,
- Damage resulting from the use of replacement or reserve parts that have not been expressly approved by the manufacturer of this product,
- Damage resulting from the use of unsuitable tools or measuring and test equipment.

## 2 GENERAL INSTALLATION INSTRUCTION FOR ECHO SOUNDERS

### 2.1 General Remark to Hydro Acoustic Equipment

Even with a carefully selected transducer position and proper installation, the function of hydro acoustic equipment can be impaired by turbulence, acoustic noise or aerated water.

As main causes, the following can be stated:

- Propeller(s) running reversed;
- Thruster(s) in operation, especially at low speed ahead;
- Engine noise, transferred to the transducer either by the hull structure or through the water, the latter especially as bottom-reflection in shallow water.
- Loosing sonar contact with the water at extremely bad weather, as a result of violent pitching.
- Hot water discharges from power plants;
- Rising cold water in several sea areas.
- The list above is not complete; we will be pleased to assist with further information on request, see also chapter 5.1.

### 2.2 Transducer Installation

The performance of an echo sounder is limited by the acoustic propagation of sound in water. This is mainly influenced by the **transducer mounting place**, the **operational frequency** and the **transducer efficiency**.

The transducer mounting place must be selected in such a way, that the transducer surface is free of air bubbles and turbulence. Air bubbles and turbulence will reflect the sound energy so that no echoes from the bottom will be returned.

Therefore transducers in general have to be installed in ship's bow.

If the ship has a bow thruster, the transducer has to be mounted ahead of it. Otherwise the turbulence caused by the thruster hole will disturb echo sounding operation.

While the bow thruster is operating, no echo sounding is possible because of the propeller rotation. On ships with bulbous bow the transducer must be mounted as far ahead as possible.

Transducers mounted in ship's aft normally are limited in function during travelling, because this area is very noisy. Due to engine noise, propeller rotation and air bubbles, the transducers are only effective during low speed travelling.

An indication for this is the disappearing of echoes, digital reading will indicate surface reverberation (1-1.5 m) or "?".

While sailing only the front transducer should be used.

### 2.2.1 Cable Length, Operating Frequency

Both the operating frequency and the length of cable between the echo sounder and the transducer influence the performance of echo sounding.

General rules are:

At **lower frequencies** the influence of air bubbles and turbulence decreases, increased depth measurements are possible, energy loss at longer cable length is minimised.

**Higher frequencies** are less sensitive against radiated water noise caused by the ships engine and propeller rotation.



**For information about ELAC-transducers (e.g. maximum measurable water depth, cable length, operating frequency) see section 5.1.3.**



## 2.2.2 Cabling, Cable Location, Cable Specification



**When installing the connection cable, observe the following:**

- Do not exceed permissible bending radius of the cables (see corresponding dimensional drawings)!
- Do not lay cable over sharp corners and edges.
- Do not use metal cable ties for fixing the cable.
- A strain relief of the cables must be installed by the shipyard.

Critical point in cabling is the correct handling of the cable screens, especially for the transducer cable.



**The cable screens have to be grounded only at one point: At the echo sounder.**

- In all connection boxes the screens are sliding and not connected to ground.
- Dismantling has to be as short as possible.

The transducer cable from the transducer to the first connection box has to be fed through a steel protection pipe.

From the first connection box to the echo sounder, the following kinds of cable laying are mandatorily recommended:

- the cable is laid in a steel pipe, that is connected to the ship's ground.



**Placing the cable duct inside a steel pipe allows to replace the transducer without docking the ship and is required by many classification associations.**

- a double-screened cable is used as transducer cable, the inner screen is one-side connected to the echo sounder's ground, the outer screen is connected to the ship's ground on both sides.

The transducer cable has to be laid separately from other cables in a distance of minimum 0.5 m.

Most important is not to lay single shielded cable in the vicinity of other cable.



**Shielded cable has to be used over the whole distance from the transducer to the echo sounder. All connection boxes must be metallic.**

### 2.2.3 Transducer Cable Specification

The cable from the transducer connection box to the echo sounder must be approved marine cable (double screened).



**At least a resistance  $<13 \Omega/\text{km}$  and a capacity of  $< 150 \text{ nF}/\text{km}$  is required.**

### 2.2.4 Interfaces

The Echo Sounder has the following interfaces:

- Printer interface: Standard CENTRONICS parallel interface, cable length: 5 m maximum.
- Serial NMEA input: Input for navigational data and time synchronisation
- Serial NMEA output: Water depth and additional information, see chapter 3.5.

Both serial interfaces are **RS 422**.



**Only NMEA-equipment with RS 422 interfaces can be connected to the echo sounder, otherwise the interface electronic will be damaged.**

## 2.2.5 Installation Checkout (Installation Report / Service Request)

### 2.2.5.1 Installation Report

After the installation and the quick check (see chapter 5.1.4) are completed, please fill in the installation report (see chapter 7.1) and send a copy to the ELAC Nautik service centre (see chapter 2.2.5.3).



**The original installation report must be inserted into the technical manual.**

### 2.2.5.2 Service Request

If service is needed in case of trouble with the echo sounder, please complete the service request/ inspection (see chapter 7.2) sheet and forward it to the service company responsible with a copy to the ELAC Nautik service centre (see chapter 2.2.5.3).

### 2.2.5.3 ELAC Nautik Service Centre



#### L-3 Communications ELAC Nautik GmbH

Manufacturer code: D1876

Neufeldtstraße 10  
24118 Kiel  
Germany

☎: ++49 (0)431 883-388

📠: ++49 (0)431 883-366

@: [elac.support@l-3com.com](mailto:elac.support@l-3com.com)



### 3 TECHNICAL DESCRIPTION

#### 3.1 General

The Navigation Echo Sounder is a compact, processor controlled, state of the art system.

Indication of the water depth is made on a Liquid Crystal (Colour) Display (LCD) as depth below the keel (DBK).



Figure 3-1: Display and Control Unit

Logically structured MENUS assist the user when selecting the operating parameters required. Built to the highest standards, the unit is certified to meet all requirements as per the IMO Resolution MSC 74/69: Amendments to Resolution A.224, Annex 4.

Wheelmark-tests are certified by the German authority BSH (German Hydrographic Institute).

#### 3.1.1 Electromagnetic Compatibility

The Navigation Echo Sounder conforms to specifications as per DIN EN 60945 (IEC945+A1) Navigation equipment for Shipping; all editions up to March 1997 and also to the newest version 4 with measurements up to 2 GHz are valid.



**A declaration of conformity, in accordance with European Community guideline 89/336/EG, is enclosed in the appendix (see chapter 7).**

### 3.2 System Configuration

#### 3.2.1 System Overview (with Options)

The basic system configuration is as follows:

- 1 x Display and Control Unit
- 1 x Connection Box
- 1 x Transducer

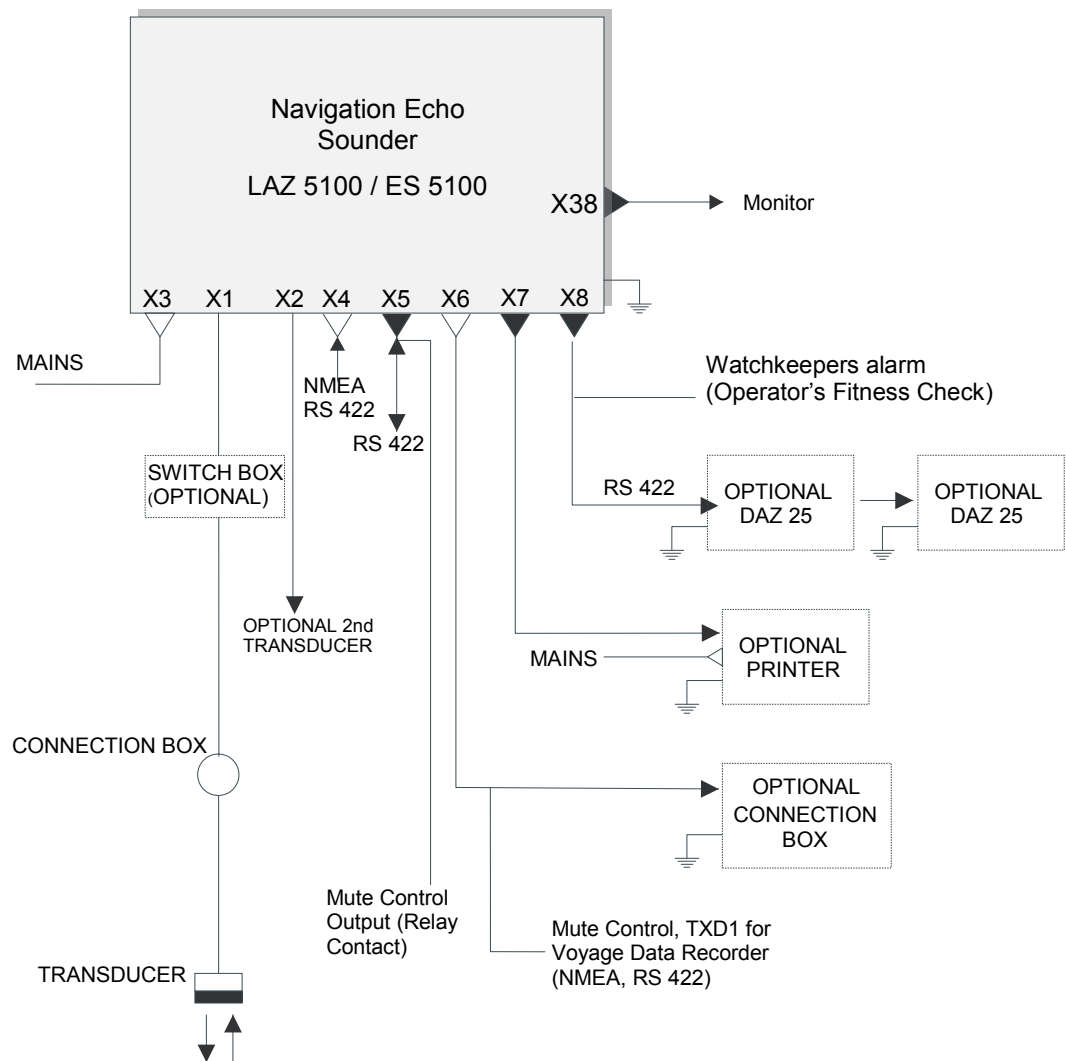

Figure 3-2: System Block Diagram (with Options)

### 3.2.2 Display and Control Unit

The Display and Control Unit will normally be installed on the bridge, either mounted in a console or bracket mounted to the deckhead or bulkhead.

It consists of a display area and a keypad which is used to alter system parameters and settings.

The unit can be a one or two channel version, working with different transducers on different frequencies, see chapter 3.4 “Technical Data”.

The display area shows the following:

#### One channel (used with only one transducer)

- Water depth
- Range scale
- Time and Date
- Latitude and Longitude (if connected to a navigation system with a standard NMEA 0183, version 2.0 interface)
- Minimum and maximum depth alarm settings (if activated)
- A trace of the sea bed
- A colour bar representing the signal strength of the echoes

#### Two channels (used with two transducers)

- vertical split display shows on the left half channel 2 information, on the right half channel 1 information.
- Instead of LAT/ LONG a second water depth indication appears.



**A built-in ring memory continually stores system data, this allows the user to recall data to the screen, or print out a hard copy of any or all events occurring within the last 24 operating hours (if a printer is connected).**

### 3.2.3 Transducer Connection Box

This will usually be installed near the transducer, to allow a defective transducer to be replaced without having to replace the complete cabling to the Display and Control Unit. The connection box must be made of metal.

### 3.2.4 Transducer

The transducer converts electrical energy to sound energy and transmits this towards the sea bed. Sound energy returning from the sea bed, in the form of echoes, is converted into electrical energy by the transducer and fed to the Display and Control Unit for evaluation and presentation.

### 3.3 Optional Equipment

The following optional equipment is available to enhance the system capabilities:

- Digital Slave Display(s) (see 3.3.1)
- Printer (see 3.3.2)
- Connection Box (see 3.3.3)
- Transducer(s) (see 3.3.4)
- Switch Box (see 3.3.5)

#### 3.3.1 Digital Slave Display(s)

These are used to repeat water depth information at other parts of the ship where such information is needed. A total of two Digital Slave Displays can be connected directly to the system.



**Echosounding systems and remote indicators which detect and display the water depth from a single momentary value per transmission pulse, e.g. digital and pointer displays, can, over a period of time, display false readings. This is primarily valid in shallow water areas. For this reason, water depths displayed in this manner must be compared with the graphic presentation at regular intervals in order to guarantee the ship's safety.**



#### **CAUTION!**

**While crossing steep slopes the echo evaluation might fail.**

- **A steady depth display cannot be guaranteed in this case.**
- **The depth display will show the last evaluated depth value together with a question mark; longer lasting errors will be indicated by a question mark without any depth value.**
- **At the digital slave display "----" will be displayed in this case.**

#### 3.3.2 Printer

A printer can be connected to give a continuous hard copy of data presented on the display or to print out a hard copy of events from any time within the previous 24 hour operating period.

#### 3.3.3 Optional Connection Box

The optional Connection Box (see Figure 3-2) is connected to the Display and Control Unit and provides the following connections:

- a second Digital Slave Display
- a blanking pulse output
- depth alarm relay contacts (potential free)



### **3.3.4 Transducer Options**

If the installed version is a dual channel version, the system is capable of accommodating two transducers without further modification, e.g. one fore and one aft, one port and one starboard.

Information received from either or both transducer(s) can be called up for display.

### **3.3.5 Switch Box**

If no dual channel version is installed, a switch box (not part of delivery) can be used for the connection of two transducers of the same type (frequency).

**3.4 Technical Data**

Designation	Value
Supply voltage, nominal	95 – 240 V AC, 50 - 60 Hz 10 - 30 V DC (option, via power pack)
Power consumption	Approx. 35 W
Operating temperature range	-15°C - +55°C
Storage temperature	-20°C - +60°C
Housing	Cast aluminium
Protection code	IP 53
Transducer impedance	50 - 150 Ohms
Pulse length	0.3, 1, 3 ms, (automatically switches to suit range selected)
Measurement ranges (or the equivalent in feet or fathoms)	0 - 10, 20, 50, 200, 500, 2000 m
Auto range	depending on the water depth, range scale of 200 m or 50 m will be selected automatically
Digital Depth Information	150% of measurement range for 0 - 10 m and 0 - 50 m 120% for other ranges
Resolution	1% of range selected
Measuring accuracy	± 1.0% of depth reading
Display	Liquid Crystal Display
Display size	192 mm x 144 mm
Pixels	640 (hor.) x 480 (vert.)
Minimum sounding depth	0.5 m or equivalent (Transducer dependent)
<b>Depth corrections:</b> Transducer-surface Transducer-keel	up to 9.9 m (up to 29,9 m starting with software version 1.82) up to 4.9 m
Standard frequencies (kHz)	24, 28, 30, 33, 38, 50, 100, 200 (selectable)
Dual Channel version	any combination of the frequencies above
Output power	1000 W Max. dependent upon range selected and transducer installed
<b>Compass Safety Distance:</b> Magnetic compass Steering compass	0.5 m 0.3 m
Dimensions (H x W x D)	288 x 336 x 156 mm
Weight	Approx. 6.1 kg
Operator Fitness Check Alarm	altering parameters of the unit causes an output to a central alarm unit (potential free relay contact)
Power Fail Alarm	when the power supply voltages decreases by 100 V, a visual and audio alarm (with mute control) is activated, a potential free output for external use is available (potential free relay contact)

Tab. 2: Technical data

TECHNICAL DESCRIPTION

3.5 Interfaces

The Navigation Echo Sounder has the following interfaces:

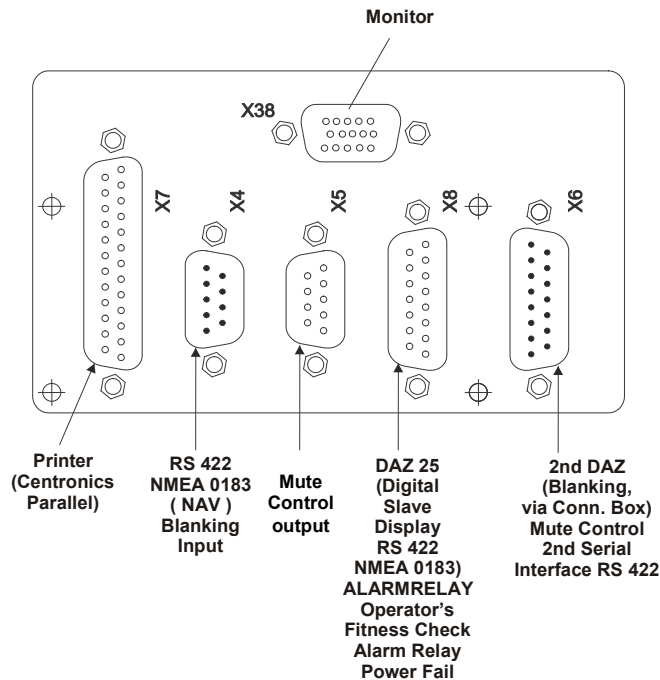

Figure 3-3: Interface Connector Plate

No.	Typ	Signal	Description
X4	D-Sub DE 9	RS 422	NMEA, for Navigation data input, Blanking input
X5	D-Sub DE 9	RS 232	Mute Control Output (relay contact)
X7	D-Sub DB 25	IEEE-1284	Centronics, parallel Printer connection
X8	D-Sub DE 15	RS 422	Digital Slave Display connection and potential free relay contacts for alarm ACTIVE, relay control for Operator's Fitness Check
X6	D-Sub DE 15	RS 422	Power supply for a 2nd Digital Slave Display, and blanking pulse output, Mute Control input, second serial output for Voyage Data Recorder, Power Fail output.
X38	D-Sub DE 15	VGA	Interface to an external monitor

Tab. 3: Interfaces



Interface connections are made at the rear of the unit. Figure 3-3 shows which connector belongs to which interface.

→ For pin connections see chapter 3.5.3 (Tab. 5: Pin connections).

**3.5.1 Description of NMEA Interfaces**



All serial interfaces described in this chapter conform to EN 61162-1 (2001).

**3.5.1.1 NMEA-Interface X4**

A navigation system can be connected to this interface so that the ship's co-ordinates are displayed by the NAVIGATION ECHO SOUNDER.

The system will accept and evaluate data sentences in NMEA 0183, Version 2.30, GLL and ZDA formats, as follows:

**GLL Format:**

`$--GLL,IIII.II,a,yyyy.yy,a,hhmmss.ss,A*hh<CR><LF>`

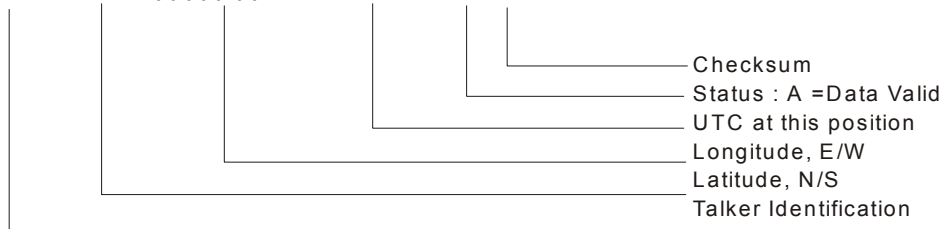

**Example:**

`$GPGLL,5420.549,N,01007.192,E,201533.25,A*02<CR><LF>`

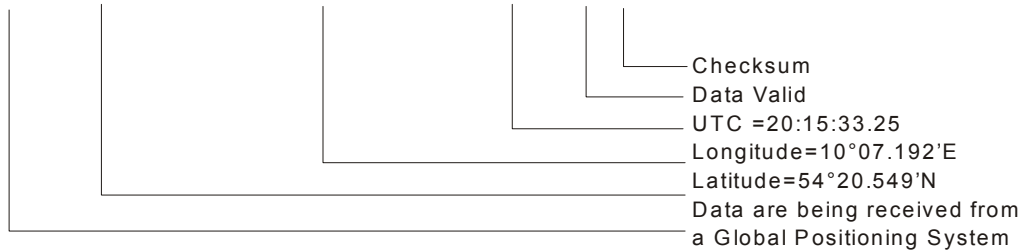

**ZDA Format:**

`$--ZDA,hhmmss.ss,xx,xx,xxxx,xx,xx*hh<CR><LF>`

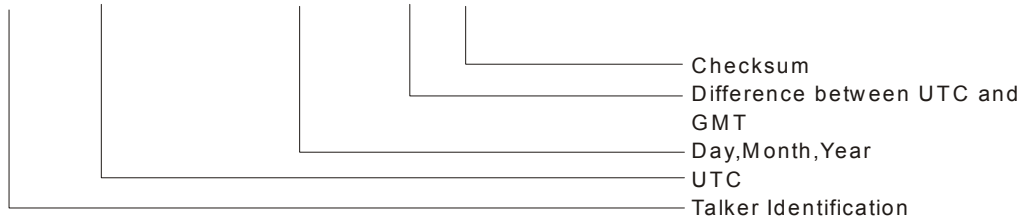

**Example:**

`$ZAZDA,184533.20,20,12,1995,12,15*62<CR><LF>`

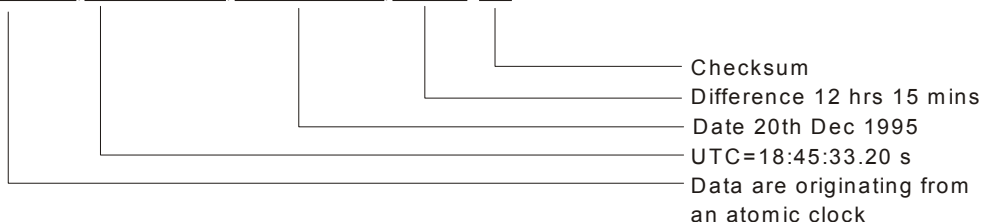

TECHNICAL DESCRIPTION

**3.5.1.2 NMEA-Interface X8**

Interface for START / STOP - SLAVE indicator, potential free alarm relay contacts and Digital Slave Indicator.

After each sounding the NAVIGATION ECHO SOUNDER transmits depth information to the Digital Slave Display interface (15 to 60 times per minute, depending upon the measuring range selected) in NMEA, Version 2.00 format. The DPT (Depth) and DBT (Depth Below Transducer) sentences are as follows:

**DPT (Depth)**

`$SDDPT,x.x,-x.x,xx,*hh<CR><LF>`

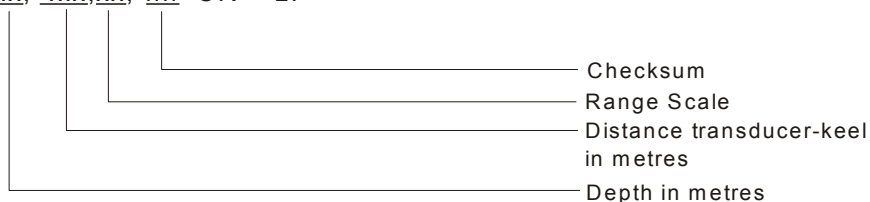

**Example:**

`$SDDPT,0337.0,-1.5,0500,*4D<CR><LF>`

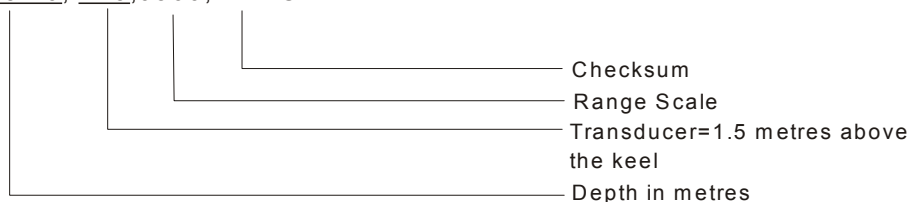

**Depth Below Transducer (DBT):**

`$SDDBT,x.x,f,x.x,M,x.x,F*hh<CR><LF>`

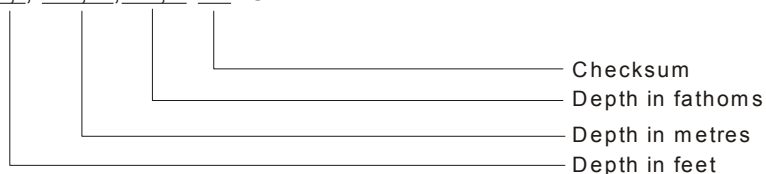

**Example:**

`$SDDBT,0012.1,f,0003.7,M,0002.0,F*32<CR><LF>`



### ELA (Manufacture's Mnemonic Code)

A NMEA proprietary sentence by ELAC is available to allow the transfer of dual channel depth information, including transducer mounting position.

\$PELACSDS,k,x.x,d.d,-t.t,m,g,r,\*hh<CR><LF>

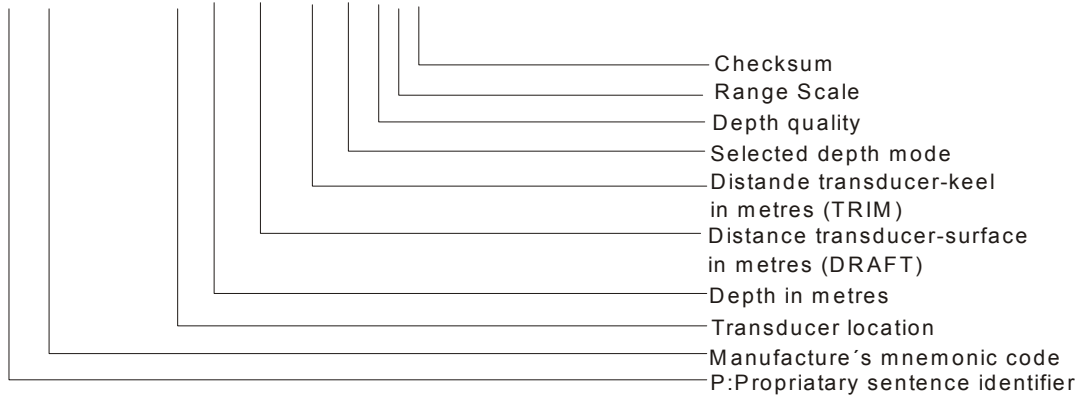

Character	Definition	Meaning
k	Transducer location	S= Starboard P= Port B= Bow A= Aft 0=not selected
m	Selected Depth mode	K=DBK (Depth below Keel) S=DBS (Depth below Surface) T=DBT (Depth below Transducer)
r	Range scale	
q	Quality of digital depth reading	0=no depth information available 1=no depth information available, poor quality 2=depth information available, high reliability

Tab. 4: ELA (Manufacture's Mnemonic Code)

### Example:

\$PELACSDS,B,0337.0,3.4,-1.5,K,2,0500,\*3F<CR><LF>

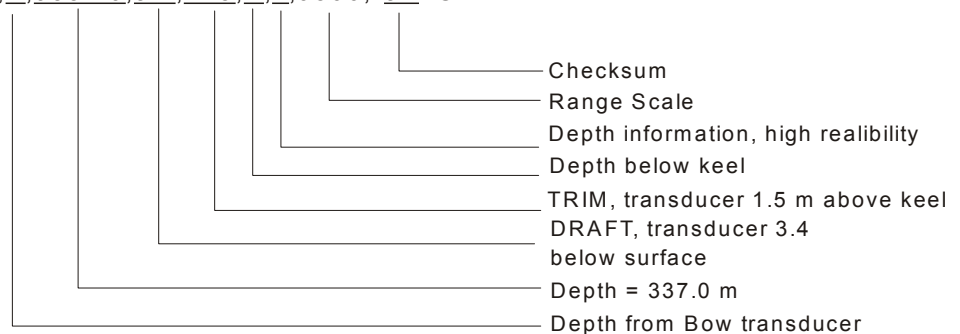

**To activate the Protocol ELAC see chapter 5.1.4 Initial System Set-Up.**

### 3.5.2 Description of the other Interfaces

#### 3.5.2.1 Interface X5

Mute Control Output (relay contact).

#### 3.5.2.2 Interface X6

This interface provides a power supply and serial data output for a second Digital Slave Display and a blanking pulse output.

#### 3.5.2.3 Interface X7

This Centronics interface allows a compatible printer to be connected to the system.



**Max. length of printer cable 5 m!**

#### 3.5.2.4 Interface X38

This is an output to connect a standard monitor to the echo sounder.

**3.5.3 Pin Connections**

Pin	Input	PC – Test ****	Output 2	Printer	Output 1	Monitor
		Mute	VDR / DAZ 25		DAZ 25	
	X 4	X 5	X 6	X 7	X 8	X 38
1	CANL ***	BSL	NMEA – Depth – Out / VDR(-)	Strobe	OFC **	Red
2	NMEA – GPS – In (+)	Test – In	NMEA – Depth – Out / VDR (+)	Data 0	OFC **	Green
3	n.c.	Test – Out	NMEA – Depth – Out (+)	Data 1	NMEA – Depth – Out (+)	Blue
4	Blanking in -	Mute – out **	Mute - in b	Data 2	n.c.	n.c.
5	Blanking in +	Ground	Mute - in a	Data 3	Alarm A ** common contact	Ground
6	CANH ***	Mute – out **	Remote – out +	Data 4	Start	Ground
7	NMEA – GPS - In (-)	n.c.	Remote – in +	Data 5	Stop	Ground
8	n.c.	n.c.	NMEA – Depth – Out (-)	Data 6	NMEA – Depth – Out (-)	Ground
9	n.c.	Vcc	Blanking out -*	Data 7	Alarm B ** open at alarm	n.c.
10	-----	-----	Blanking out +*	ACK	Alarm C ** closed at alarm	Ground
11	-----	-----	Aux. Voltage +	BUSY	Aux. Voltage +	n.c.
12	-----	-----	Remote RS	Paper End	Power fail 1 **	n.c.
13	-----	-----	Remote – out -	Select	Power Fail 2 **	Hsync
14	-----	-----	Remote – in -	n.c.	LSE 2+2	Vsync
15	-----	-----	Aux. Voltage -	Error	Aux. Voltage -	n.c.
16	-----	-----	-----	Reset	-----	-----
17	-----	-----	-----	n.c.	-----	-----
18	-----	-----	-----	Ground	-----	-----
19	-----	-----	-----	Ground	-----	-----
20	-----	-----	-----	Ground	-----	-----
21	-----	-----	-----	Ground	-----	-----
22	-----	-----	-----	Ground	-----	-----
23	-----	-----	-----	Ground	-----	-----
24	-----	-----	-----	Ground	-----	-----
25	-----	-----	-----	Ground	-----	-----

Tab. 5: Pin connections



## 4 OPERATING INSTRUCTIONS



### CAUTION!

Operating errors possible!

→ The system must be operated by trained, qualified personnel only!

### 4.1 Switching the System On/Off



The transducer will be destroyed if operated out of water!

→ Operate the system (if necessary) only when the transducer is immersed in water!



Figure 4-1: Display and Control Unit

To switch the System **ON**, press the far right-hand key marked "ON". The system will switch **ON** and recall the parameter settings which were selected when the system was last switched **OFF**.

To switch the system **OFF**, press and **hold** the second key from the right, marked "OFF", the system will switch **OFF** after about 3 to 5 seconds. This is a built-in safety feature to prevent accidental switching **OFF**.



For brief explanation of the control keys see chapter 4.2.

**4.2 Brief Explanation of Control Keys**

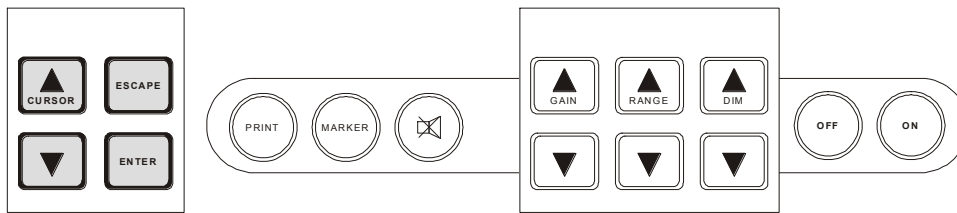

Figure 4-2: Keypad

Key	Value
<b>CURSOR</b>	The <b>CURSOR</b> keys allow the user to move the cursor within a <b>MENU</b> and alter parameters. The position of the cursor can easily be seen, the word, letter or digit marked by the cursor appears inverse (dark background, light text).  Parameters to be altered must first be "marked" with the cursor.
<b>ESCAPE</b>	The <b>ESCAPE</b> key is used to leave a <b>MENU</b> or to abort parameter alterations.
<b>ENTER</b>	The <b>ENTER</b> key is used to call up <b>MENUS</b> and confirm parameter alterations within <b>MENUS</b> .
<b>GAIN</b>	The <b>GAIN</b> keys are used to alter the system gain, known as amplification, to achieve a clearer presentation in automatic gain control mode. See chapter 4.4.1.
<b>RANGE</b>	The <b>RANGE</b> keys are used to set the depth range of the system.
<b>DIM</b>	The <b>DIM</b> keys are used to set the display backlighting level to suit the user.
<b>PRINT</b>	The <b>PRINT</b> key is used when the user wants to make a simultaneous hard copy of the echogram. This is only possible if a printer is connected to the system.
<b>MARKER</b>	When the <b>MARKER</b> key is pressed, a vertical dotted line appears on the screen and moves with the presentation from right to left. At the same time all relevant information is stored in the system's 24 hour memory. This memory stores data from the previous 24 operating hours.
<b>SYMBOL</b>	The key marked with a loudspeaker symbol is used to acknowledge acoustic depth alarms.

Tab. 6: Control keys

OPERATING INSTRUCTIONS

**4.3 Display Area**

**4.3.1 Single Channel Display**

The Display Area is used to present all relevant information. The screen is divided into two areas. The lower, main area is used to present an echogram of the scenario beneath the ship. It is provided with a scale and time markings. The range in use is displayed beside the scale markings, at the bottom right of the screen. The time markings appear at 3 minute intervals at the bottom edge of the screen.



**As explained previously, when MENUS are called up, they will appear at the bottom left-hand side of this area.**

The smaller strip across the top of the screen provides the user with various system and depth information (see illustration below).

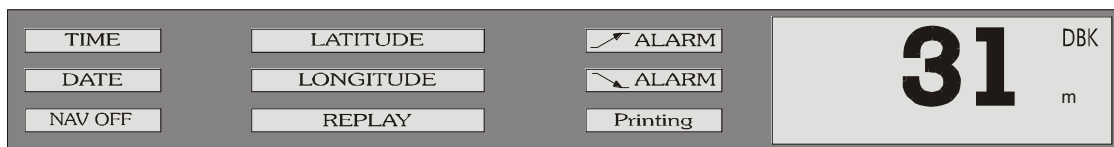

Figure 4-3: Single Channel Display

Explanation of information contained in the illustration above:

Information	Explanation
<b>TIME</b>	Shows the actual time
<b>DATE</b>	Shows the actual date
<b>NAV OFF</b>	Flashes to indicate that the Navigation mode is not in use i.e. the user have selected other units, sound velocity or depth mode. When the user returns to the Navigation mode, by selecting NAV Defaults, this window will disappear (see also chapter 4.5.1.1, NAV-Defaults). If the echo sounder is in the dual channel mode (only if the second channel and a second transducer is fitted), NAV - OFF is activated without flashing.
<b>LONGITUDE/ LATITUDE</b>	These windows will display the actual Lat. and Lon. (only if the system is connected to the ship's navigation system).
<b>Printing</b>	This window is usually blank. If the user chooses to make a hard copy of the echogram, by pressing the printer key (a printer must be connected) the word "Printing" will appear here.
<b>ALARM</b>	These windows show the depth alarm settings. The upper window shows the minimum depth alarm, the lower window shows the maximum depth alarm. If the alarms are not activated, e.g. Status = OFF, the relevant window(s) will remain blank. If an alarm condition occurs, the relevant window will flash.
<b>REPLAY</b>	When the user chooses to display information stored over the previous 24 operating hours (using the LOG DATA MENU), the word "REPLAY" will appear here.

Tab. 7: Shown information

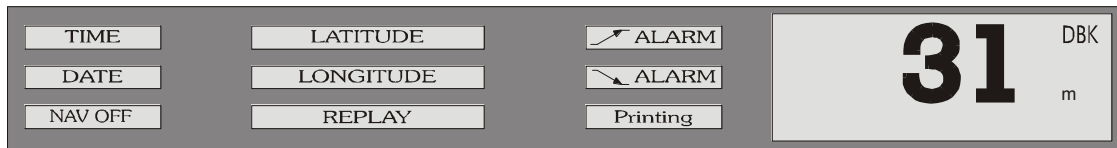

Figure 4-4: Single Channel Display

The large window at the right-hand side of the information area is used to display the actual water depth, the measurement mode, units of measurement. The measurement mode can be either:

- Depth Below the Keel = DBK (as shown)
- Depth Below the Surface = DBS
- Depth Below the Transducer = DBT

The units of measurement can be either:

- Meters (m; as shown)
- Feet (ft)
- Fathoms (ftm)



### WARNING!

If no valid bottom depth is available, instead of the depth value a “?” appears. The reason can be loss of the bottom signal by distortion or other influence or the bottom depth is out of the selected range.

Therefore in case of the “?” appearance check the selected range and the analogue bottom trace.



While crossing steep slopes, the echo evaluation might fail. A steady depth display cannot be guaranteed in this case. The depth display will show the last evaluated depth value together with a question mark; longer lasting errors will be indicated by a question mark without any depth value. At the digital slave display "----" will be displayed in this case.

### 4.3.2 Two Channel Display

In the two channel mode, information about location and frequency of the transducer in use is added.

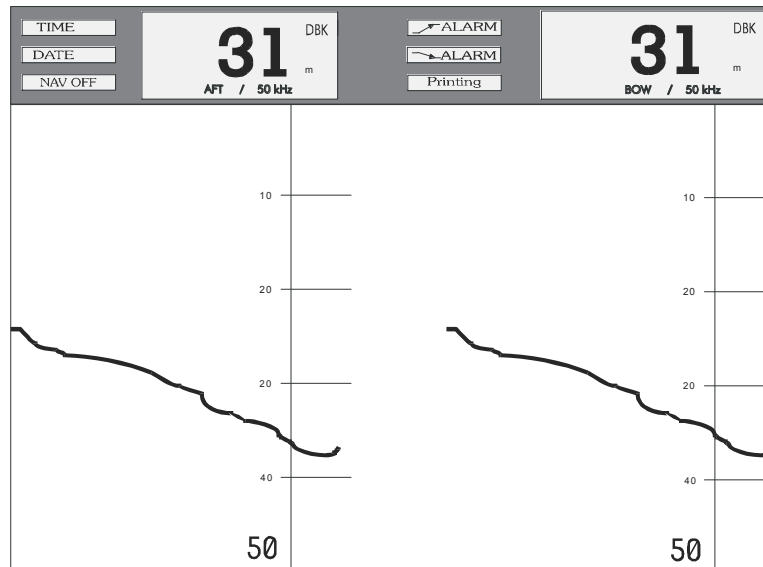

Figure 4-5: Two Channel Display

If the presentation channel 1/2 is selected, Information of both channels is shown in a vertical split display.



The indication NAV OFF is activated without flashing to indicate, that the mode of presentation is non standard. For each transducer the depth location and frequency is shown.



For transducer location and frequency see chapter 5.1.4 Initial System Set-Up.

#### 4.3.2.1 Warning Fields

Three warning fields are shown on the display:

Field	Explanation
NAV OFF	<ul style="list-style-type: none"> <li>NAV OFF flashing indicates that one or more parameters do not correspond to the navigational mode, i.e. the user has selected other units, sound velocity or depth mode.</li> <li>NAV OFF without flashing appears in the 2 channel mode. It indicates that in this display mode the user has to observe, that for instance digital slave repeaters are in use.</li> </ul>
POWER ERROR	POWER ERROR occurs when the supply voltage of the echo sounder unit falls below a value of 100 V AC. This is an internal alarm, the POWER ERROR field flashes and an acoustic alarm (with mute control) is activated.

Tab. 8: Shown information

## 4.4 Altering System Parameters and Settings

When the system is switched OFF, parameters selected are stored in the system's memory. When the system is switched ON again, these parameters will be retrieved and used (see NOTE below).



The "DIM" setting is not stored; a pre-set default setting is used when the system is switched ON. With two channel systems, channel 1 is the default channel at start-up.

### 4.4.1 GAIN, RANGE and DIM Settings

**GAIN** (amplification), **RANGE** (depth range) and **DIM** (display area background lighting and keypad illumination) settings are made by pressing the relevant keys.

There are two keys for each setting, one marked with an arrow pointing upwards and one marked with an arrow pointing downwards. Pressing these keys as described below will alter the present setting. The new setting will appear briefly on the display area directly above the key which was pressed and the effects of a change can be observed directly on the display area. Pressing the key a second time will alter the setting by a further unit.

#### 4.4.1.1 GAIN Settings

The unit is fitted with an automatic gain control circuit for the data processing which is always activated when the unit is switched on. The **GAIN** setting only influences the displayed echo information. The **GAIN** value can be altered between 1 and 10, whereby 1 is the lowest and 10 the highest gain (amplification) factor.

If the sea bed trace appears too weak, the **GAIN** level must be increased to give a clear presentation. If there is a lot of "noise" to be seen on the display area, the **GAIN** level must be decreased.

To **increase** the GAIN level, press the **GAIN key ▲**. To **decrease** the **GAIN** level, press the **GAIN key ▼**.

The set value will appear on the display area above the key (between 1 and 10). Pressing the same key a second time will increase or decrease the value by one further unit. Repeat the procedure until a satisfactory sea bed trace is achieved.

In some cases it can be useful to work with manual instead of automatic gain. Manual gain setting is explained in chapter 4.5.2.5.

#### 4.4.1.2 RANGE Settings

The **RANGE** can be set to suit the circumstances e.g. if a water depth of 35 m is indicated, the 50 m range will give a better resolution and accuracy than the 200 m range.

The range can be altered in the same way as the gain, except that here, pressing the **RANGE key ▲** will **decrease** the range and pressing the **RANGE key ▼** will **increase** the range.

There are 6 ranges to choose from, 10, 20, 50, 200, 500 and 2000 m (or the equivalent in fathoms or feet). Selecting the unit of measurement is described in chapter 4.5.2.3.

When increasing the range to more than 2000 m scale, an "A" will appear together with the 200 m scale. "A" indicates the selection of the automatic mode. When the water depth decreases to a depth less than 50 m, the range will automatically switch to the 50 m range scale; if the water depth increases, the 200 m range will be selected. By pressing the range keys in the automatic mode, manual control is activated.



**When DBS is used, the ranges 0-10 m; 0-20 m are not available, only 0-50 m.**

#### 4.4.1.3 DIM Settings

The display background lighting can be set in 10 steps to suit the ambient light. To **increase** the display background lighting, press the **DIM key ▲**. To decrease the display background lighting, press the **DIM key ▼**.



**All other parameters and settings are altered within so called MENUS, as described in chapters 4.4.2 and 4.5.**

#### 4.4.2 General Information Regarding Menus

The **ENTER** key is used to call up the various **MENUS** in sequence.

They appear in the following order:

- Press the **ENTER** key 1x : **ALARM MENU**
- Press the **ENTER** key 2x : **PARAMETER MENU**
- Press the **ENTER** key 3x : **LOG DATA MENU**
- Press the **ENTER** key 4x . **SYSTEM SETUP MENU**



If the **ENTER** key is pressed 5x, the **ALARM MENU** will re-appear.

When a **MENU** is called up, the title will be highlighted i.e. it will appear in inverse text, this means light text on a dark background or vice versa, depending on the **DIM** setting. During daylight use, the text will be light on a dark background and during darkness, when the screen is dimmed, the text will be dark on a light background.

When the title line of a **MENU** is highlighted, it is possible to leave that **MENU** by pressing the **ESCAPE** key 1x, or to change to another **MENU** by pressing the **ENTER** key 1x or more often, until the desired **MENU** appears.

If parameters or settings have been altered within a **MENU**, the **ESCAPE** key may have to be pressed more than 1x in order to either return to the title line or to leave the **MENU** completely. The **ESCAPE** key can also be used to abort parameter selections.

A detailed example of altering system settings and parameters within a **MENU** can be seen in chapter 4.4.3. The user should read this section thoroughly and practice the alterations described in order to become familiar with the system.



#### **WARNING!**

**Do not alter parameters within the SERVICE SUB-MENU unless authorised to do so. See also WARNING given in chapter 4.5.4 "The SYSTEM SET-UP MENU".**



### 4.4.3 Altering System Settings/Parameters within a Menu

When a **MENU** is called up, it will appear at the bottom left-hand side of the display area. There are 4 main **MENUS** available. These can be called up by pressing the **ENTER** key.

**Example:**

The user wants to change the MINIMUM DEPTH ALARM from 30 m to 20 m and activate it (Status = ON) and to change the MAXIMUM DEPTH ALARM to 410 m and activate it.

Press the **ENTER** key once to call up the **ALARM MENU**. The **ALARM MENU** as shown below appears at the bottom left-hand side of the display area.

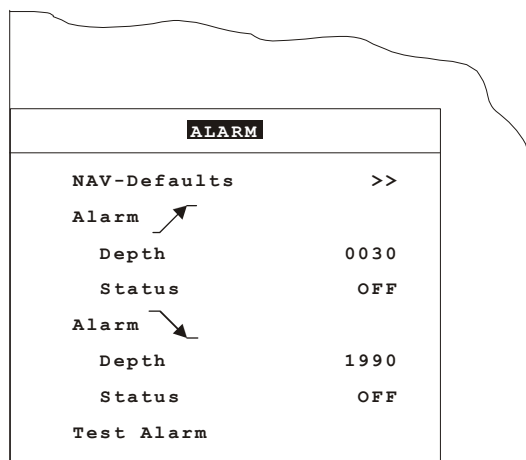

Figure 4-6: Alarm Menu

The word **ALARM** is marked by the cursor and appears inverse, i.e. dark background, light text.

In order to alter the **MINIMUM DEPTH ALARM** setting within this **MENU**, the value to be altered must be marked by the cursor. This is done by using the **CURSOR** keys. The **CURSOR** key with the arrow pointing downwards (▼) is used to move the cursor down and the **CURSOR** key with the arrow pointing upwards (▲) is used to move the cursor up. Press the **CURSOR ▼** key twice to mark the word "Depth".

The **MENU** below shows that the cursor has been moved down to mark the word "Depth" which now appears inverse.

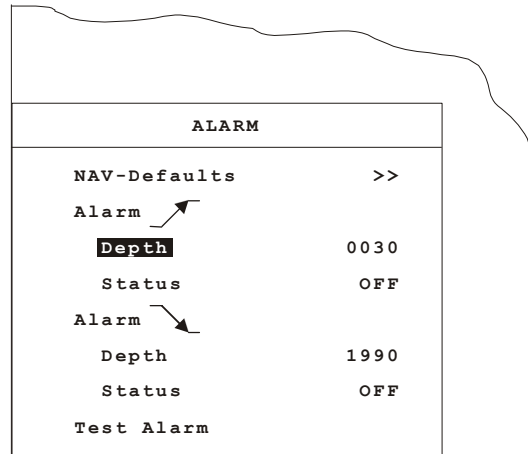

Figure 4-7: Alarm Menu

Now press the **ENTER** key. The cursor will move from the word "Depth" to the first digit of the alarm setting, in this case a zero. Press the **ENTER** key twice more and the cursor will move to the right (and mark the number 3) as shown in the **MENU** below.

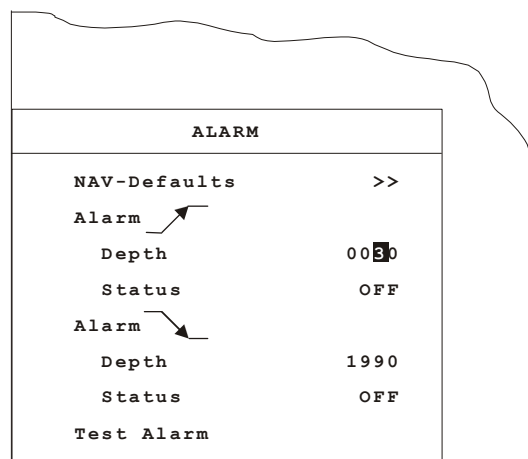

Figure 4-8: Alarm Menu

Press the **CURSOR ▼** key once. The number 3 will change to a 2.

Press the **ENTER** key to confirm the new setting. The cursor will move one digit to the right.

OPERATING INSTRUCTIONS

Press the **ENTER** key once more and the cursor will move to mark the word "Status" as shown in the **MENU** below:

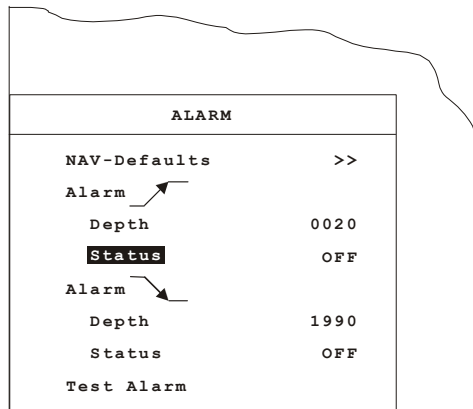

Figure 4-9: Alarm Menu

Press the **ENTER** key and the cursor will move to the word "OFF". Press a **CURSOR** key (▲ or ▼) to toggle from **OFF** to **ON**. The **MENU** will appear as below.

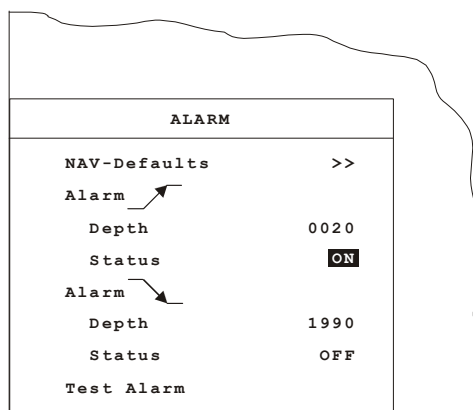

Figure 4-10: Alarm Menu

Press the **ENTER** key to confirm the setting. The cursor will move to the word "Depth" as shown in the **MENU** below.

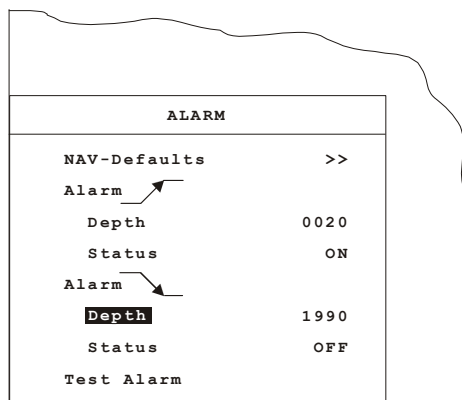

Figure 4-11: Alarm Menu

Press the **ENTER** key and the cursor will move to the first digit of the alarm setting, in this case a 1, as shown in the **MENU** below.

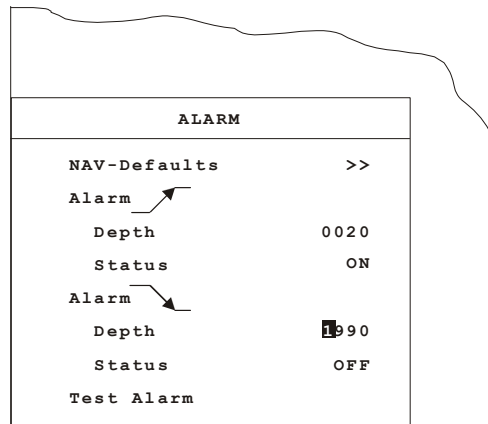

Figure 4-12: Alarm Menu

Change 1 to a 0 by pressing the **CURSOR ▼** key. Press the **ENTER** key to confirm. The cursor will jump to the next digit, a 9.

Press the **CURSOR ▼** key repeatedly until the desired value is reached, in this case a 6. Press the **ENTER** key to confirm. The cursor will move to the next digit, again a 9. Set this to 1 using the **CURSOR ▼** key. Press the **ENTER** key to confirm, the cursor moves to the 0 which need not be altered.

Now that the desired value, 410 m, has been set, press the **ENTER** key to confirm. The cursor will move to the word "Status" as shown in the **MENU** below.

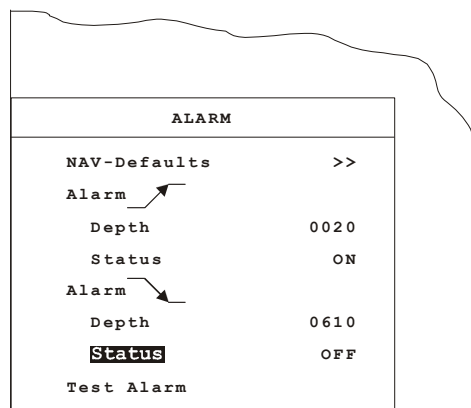

Figure 4-13: Alarm Menu

Press the **ENTER** key and the cursor will move to the word "**OFF**".

The **MENU** will appear as shown overleaf.

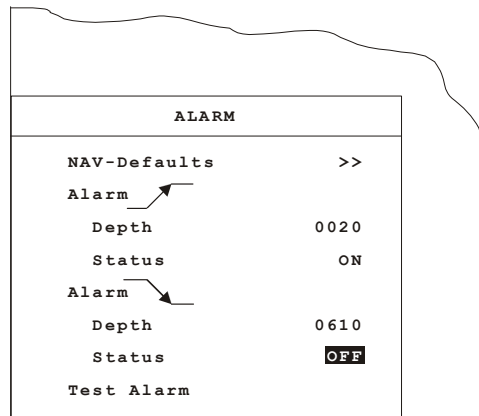

Figure 4-14: Alarm Menu

Alter the Status to **ON** as described for the minimum depth alarm. Press the **ENTER** key to confirm. The cursor will move to the words "Test Alarm", as shown in the **MENU** below.

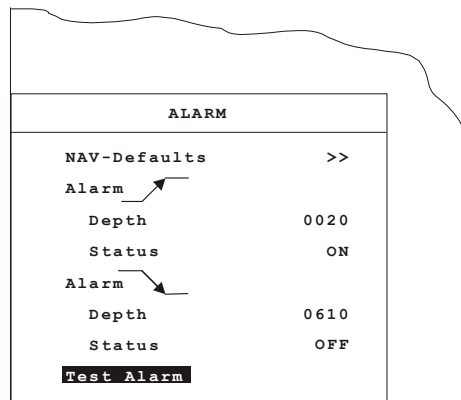

Figure 4-15: Alarm Menu

A functional test of the audio/visual alarm can now be carried out by pressing the **ENTER** key. The audio alarm must sound and the field(s) showing the alarm setting(s) on the display area must blink.

Now that the settings have been altered and the alarm tested by pressing the **ENTER** key, leave the **MENU** by pressing the **ESCAPE** key twice.

## 4.5 Menu Description

### 4.5.1 The ALARM Menu

To call up the **ALARM MENU**, press the **ENTER** key once.

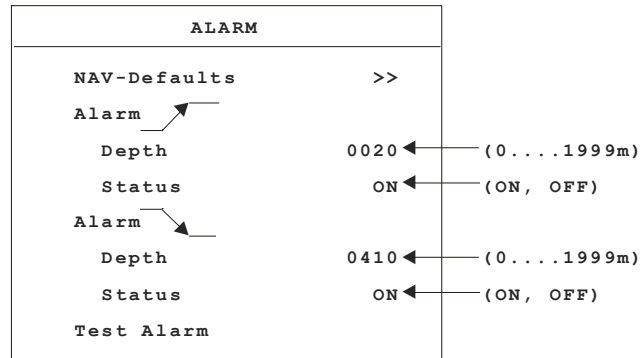

Figure 4-16: Alarm Menu

This **MENU** is used to set, select or test the following:

- Select NAV-Defaults
- Set Minimum Depth Alarm
- Set Maximum Depth Alarm
- Test the Alarm system

#### 4.5.1.1 NAV-Defaults

**NAV (Navigation)-Defaults** are basic compulsory settings which must be used when operating the system for navigational purposes. These are defined by the International Maritime Organisation (IMO) and state that:

- The system must operate with one channel only
- The sound velocity must be set to 1500 m/s
- The unit of measurement must be metric ( meters)
- Water depth must be measured below the keel (DBK)

If the system is being operated in any other mode, e.g. units selected are feet or fathoms, water depth from the surface is selected etc., the user can return to the **NAV** mode by calling up this **MENU** and selecting **NAV-Defaults**. A sub menu will appear in which the user can choose between selecting **NAV-Defaults** and returning to the **ALARM MENU**. The sub menu is shown overleaf.

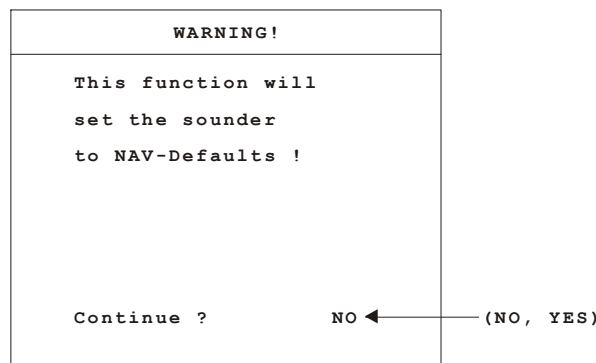

Figure 4-17: Alarm Menu (Warning)

To set the system back to **NAV defaults**, call the **ALARM MENU** and press the following keys:

- **CURSOR ▼** (1x, to mark NAV-Defaults)
- **ENTER** (1x, to call up **SUB-MENU**)
- **CURSOR ▼** or **▲** (to select **YES**)
- **ENTER** (to confirm selection and exit **SUB-MENU**)
- **ESCAPE** (1x, to leave the **MENU**)

#### 4.5.1.2 Maximum and Minimum Depth Alarms

The user can set the system alarm so that an audio/visual alarm is released if the water becomes more shallow than a set minimum or deeper than a set maximum. This depth is always measured from the ship's keel. An Alarm Test facility is available so that the alarm function can be periodically tested. These settings are done as described in chapter 4.4.3.



**The audio alarm can be muted externally by a connected Mute Control.**

## 4.5.2 The PARAMETER Menu

To call up the **PARAMETER MENU**, press the **ENTER** key twice.

PARAMETER		
Channel Select	1	← (1, 2, 1/2)
Sound Velocity	1500	← (1400...1699)
Units	m	← (m, ftm, ft)
Depth Mode	DBK	← (DBK, DBT, DBS)
Gain	auto	← (Auto, Man)

Figure 4-18: Parameter Menu

The **PARAMETER MENU** is used to select system parameters which vary from those laid down by the IMO. The following settings can be made within this **MENU**:

- Channel selection
- Sound velocity setting
- Selection of measurement units
- Depth mode selection

### 4.5.2.1 Channel Select

The Channel Select function is only operative in dual channel equipment.

When the system is switched on, channel 1 is the default setting. This function is used to select the channel to be shown on the display area.

Presentation of Channel 1, Channel 2, or both channels is possible. If both channels are selected, they will appear side by side on the display area, Channel 1 to the right and Channel 2 to the left.

Call up the **PARAMETERS MENU** and press the following keys to make a selection:

- **CURSOR ▼** (1x, to mark Channel Select)
- **ENTER** (1x, to mark Channel number)
- **CURSOR ▲** or **▼** (to make selection)
- **ENTER** (1x, to confirm selection)
- **ESCAPE** (2x, to leave the **MENU**)



#### 4.5.2.2 Sound Velocity

Sound travels at varying speeds in water, depending upon salinity, temperature and density. The standard NAV (Navigation) default setting for sound velocity is 1500 m/s.

If a sound velocity measuring system is available and the user wants to adjust the sound velocity of the depth sounder, call up the **PARAMETERS MENU** and press the following keys:

- **CURSOR ▼** (2x, to mark Sound Velocity)
- **ENTER** (1x, to mark 2nd digit)
- **CURSOR ▲** or **▼** (to alter 2nd digit)
- **ENTER** (1x, to confirm selection and jump to 3rd digit)
- **CURSOR ▲** or **▼** (to alter 3rd digit)
- **ENTER** (1x, to confirm selection and jump to 4th digit)
- **CURSOR ▲** or **▼** (to alter 4th digit)
- **ENTER** (1x, to confirm selection)
- **ESCAPE** (2x, to leave the **MENU**)

#### 4.5.2.3 Units

The standard default unit of measurement is meters. . It is, however, possible to choose either fathoms or feet.

In order to alter the unit of measurement, call up the **PARAMETERS MENU** and press the following keys:

- **CURSOR ▼** (3x, to mark the word **Units**)
- **ENTER** (1x to mark units selected)
- **CURSOR ▲** or **▼** (to make selection)
- **ENTER** (1x, to confirm selection)
- **ESCAPE** (2x, to leave the **MENU**)

#### 4.5.2.4 Depth Mode

The standard default depth measurement mode is **DBK** (depth below the keel). It is however possible to change this mode to either **DBT** (depth below the transducer) or **DBS** (depth below the surface).

In order to alter the mode of depth measurement, call up the **PARAMETERS MENU** and press the following keys:

- **CURSOR ▼** (4x, to mark **Depth Mode**)
- **ENTER** (1x, to mark the mode selected)
- **CURSOR ▲** or **▼** (to make selection)
- **ENTER** (1x, to confirm selection)
- **ESCAPE** (2x, to leave the **MENU**)



**When the NAV-Defaults are selected within the ALARM MENU, the system returns to the navigation mode, using the default values, i.e.:**

- Channel Select = 1
- Sound Velocity = 1500 (m/s)
- Units = m
- Depth Mode = DBK

#### 4.5.2.5 Manual Gain Setting

In a noisy environment or if the bottom depth changes very rapidly it is useful to work with **manual gain** instead of **automatic gain**.

The manual mode is selected as follows:

- Select second menu (PARAMETER) by pressing **ENTER, ENTER**
- Select in the PARAMETER menu **Gain** using the cursor, **ENTER**
- With the cursor change **Auto** to **Man.**, **ENTER**
- With the **GAIN** key gain can now be adjusted
- With **GAIN UP** or **DOWN** gain can be set between 1 (minimum) and 15 (maximum)

Change the gain value until the bottom is clearly indicated on the display. For differentiation, the gain value selected is shown inversely on the display during the use of the gain keys:

Indication with Auto:

Indication with Man.:



**During switch off the last gain value used is stored. If the unit is switched on again, Auto mode is selected. If Man. is selected as described, the last gain value stored will be recalled.**

### 4.5.3 The LOG DATA Menu

To call up the **LOG DATA MENU**, press the **ENTER** key three times. The **MENU** as shown below will appear.

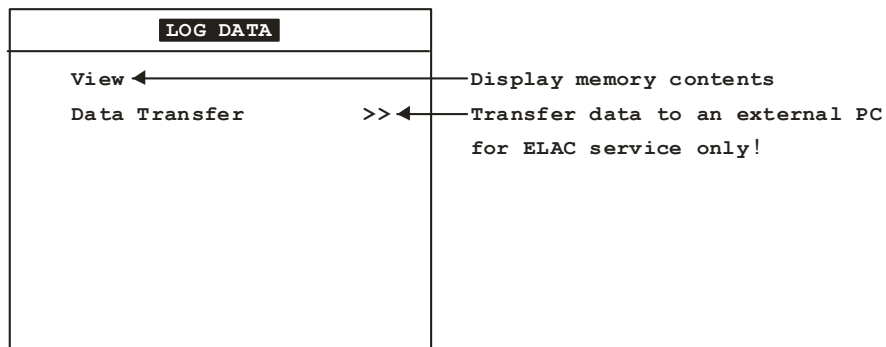

Figure 4-19: Log Data Menu

The **LOG DATA MENU** is used to gain access to data stored in the system's built-in 24 hour ring memory. This data can be viewed on the display area and printed out in full or in part (if an external printer is connected).



#### WARNING!

During this mode, the echo sounder is not in operation and no actual depth data will be given. ALARM functions will not be in effect. No data will be stored.

#### 4.5.3.1 To View Stored Data

Call up the **LOG DATA MENU** as described previously. Press the **CURSOR ▼** key once to mark the word "**VIEW**", followed by the **ENTER** key.

The **MENU** will disappear from the screen and stored data will appear. A typical Viewed Data display area is shown below.

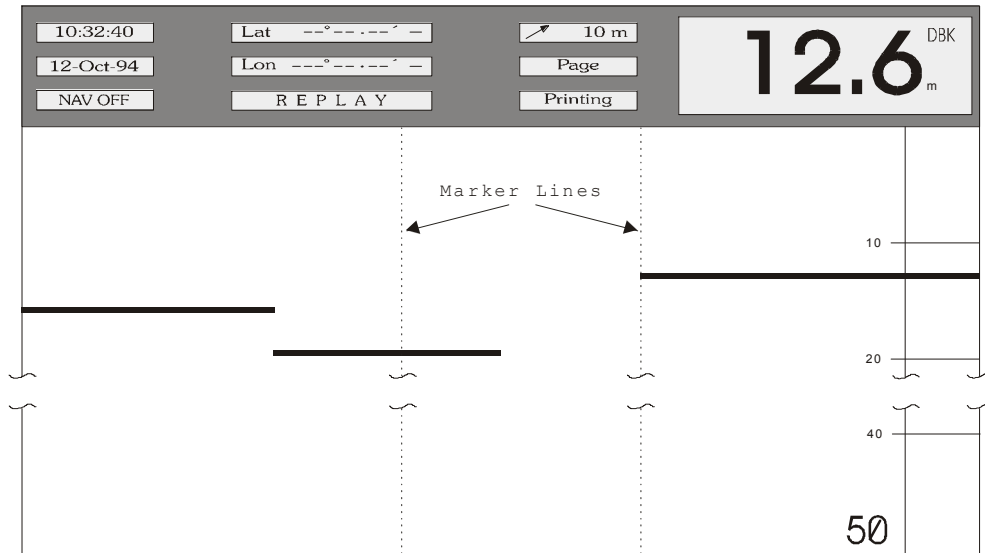

Figure 4-20: Log Data Menu

The upper part of the display area contains the following information which is always related to the first data block on the extreme right of the display area:

- Time and date of stored data
- NAV Mode ON or OFF (if the NAV mode was ON when data was stored, this window will not be shown)
- Latitude and Longitude (only if the system was connected to an external navigation system)
- The window showing REPLAY indicates that stored data are being viewed
- Depth setting of the shallow water alarm (10 m, if this function was selected)
- Depth, unit (m) and mode (DBK) of measurement
- Depth range (50 m)
- the "Page" and "Printing" windows will be explained later

4.5.3.2 Explanation of Controls for Viewing Stored Data

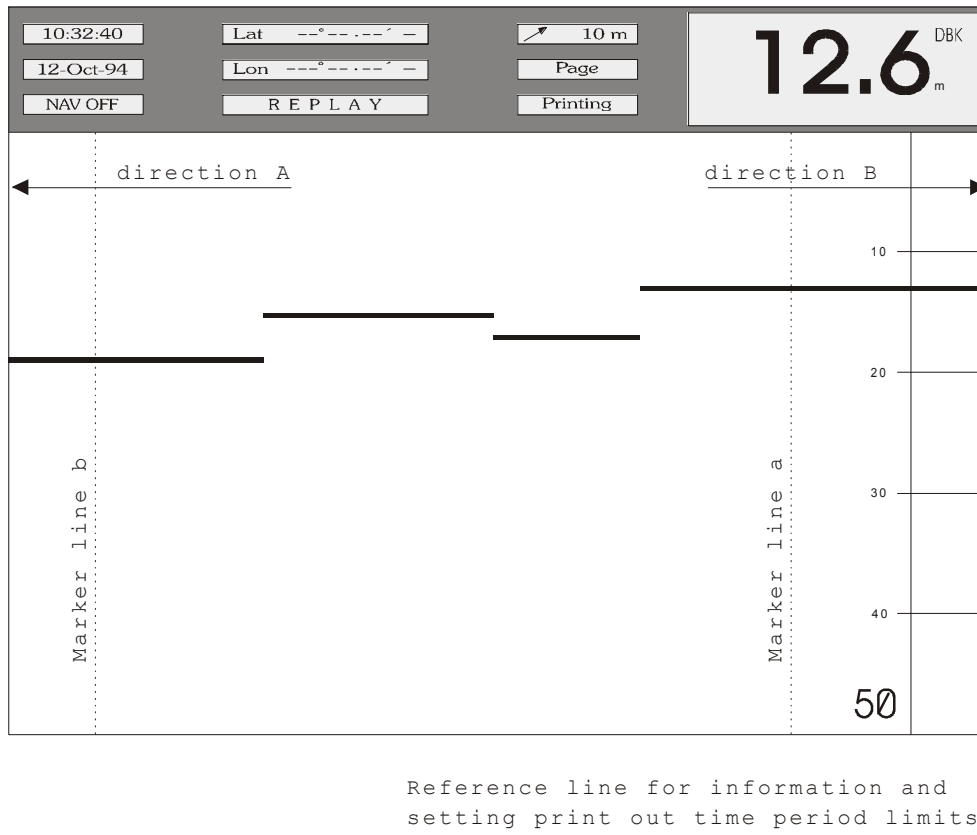

Figure 4-21: Log Data Menu

Controls for Viewing Data	
Key	Function
CURSOR ▲	Scrolls forwards in time (direction A)
CURSOR ▼	Scrolls backwards in time (direction B)
ENTER	Toggles page scroll option (for faster scrolling)
MARKER	Marks one limit of the time period to be printed out (start or finish)
PRINT	Marks the other limit of the time period to be printed out and simultaneously activates the printer (if connected)
ESCAPE	Exit, return to the echo sounding mode



**With the exception of the DIM and OFF keys, all keys are inoperative.**

### 4.5.3.3 Scrolling through Memory Data

To scroll the display to a certain time in the memory in order to view events that occurred earlier (relative to time shown in "time" window), press and hold the **CURSOR ▼** key until nearing the wanted time (shown in the "time" window).

Finely adjust the wanted time by pressing the **CURSOR ▲** or **▼** key momentarily, each time a key is pressed, the time will advance by a 5 second period.

If the event to be viewed occurred considerably earlier, scrolling can be accelerated by using the "Page scroll" option. Press the **ENTER** key and the word "Page" will appear in the window beneath the "Depth Alarm" window. When the **CURSOR ▲** or **▼** keys are now pressed, the display will be shifted by approx. three quarters of a page backwards or forwards (pressing and holding these keys scrolls continuously).

#### **EXAMPLE:**

To view data at the time when "Marker line a" was set, press and hold the **CURSOR ▼** key until the marker line is almost at the right-hand side of the display area. Finally adjust by pressing the **CURSOR ▼** repeatedly until the marker is at the outer right-hand side of the display area.

The data will now be presented in the upper part of the display. To move "Marker line b", press the **ENTER** key. The word "Page" will appear in the window below the alarm window showing that the "Page scroll" option is activated. When the **CURSOR ▼** is now pressed once, the marker line will move to the right. Press the **ENTER** key to return to the "slow scroll" option and finally adjust as previously described for "Marker line a".



**Depth, scale and position information will not be updated during scrolling (only time and echograms) except when a marker line passes the right-hand border of the display area.**

The following information can be read off the display for any given time during the previous 24 system operating hours:

- Water depth at that time
- Units and mode of measurement at that time
- Range in use at that time
- Time and date when the information was stored
- Whether the NAVIGATION mode was in use at that time
- Latitude and Longitude when the information was stored (if connected to a navigation system)
- Whether a shallow water alarm was activated at that time

#### 4.5.3.4 Printing Data from the Memory

In order to make a print-out of all or part of the data stored in the memory, so called "limit markers" must be set. Only data within these limit markers will be printed.

To set these limit markers and print the data within them, proceed as follows:

- Scroll the display area until one limit is reached (the time is shown in the "time window").
- Press the **MARKER** key (the time of the right hand side of the display appears in a window below the depth alarm window)
- Scroll the display area until the other limit is reached (the time is shown in the "time window").
- Press the **PRINT** key, the time in the window below the depth alarm window will be replaced by the word "Wait", followed by the word "Printing" within short.

During printing, the user may scroll further within the memory. The print-out can be stopped at any point by pressing the **PRINT** key for a second time.

#### 4.5.3.5 Fault Conditions during Print

When the **PRINT** key is pressed, a fault condition may occur.

If so, one of the 3 fault conditions shown below will be indicated in the window beneath the depth alarm window:

- PERIOD?** : This indicates that the user has set both limit markers to the same time. The limit markers must be set to different times.
- PAPER OUT** : The printer has run out of paper
- ERROR** : The printer is not connected, not switched ON, or otherwise defective

#### 4.5.3.6 Making a Hard Copy of the Screen Data

In order to make a hard copy of data displayed on the screen, scroll to the desired position and press the **PRINT** key. A window will appear containing the word "Hardcopy". The print-out will be an exact reproduction of the screen at the time the **PRINT** key was pressed.



**With the exception of the PRINT and ESCAPE push-buttons, all other controls are disabled during the time it takes to print out a hard copy of the screen. The PRINT push-button will stop the printing process and the ESCAPE push-button will exit the LOG-DATA feature and return the system to echo-sounding operation.**

#### 4.5.4 The SYSTEM-SETUP Menu



### WARNING!

With the exception of time, date and colour, no other parameters must be altered unless modifications are made to the system, e.g. altering the installation depth of the transducer or replacing the transducer with one of a different frequency. Alteration of such parameters must only be made by an experienced service technician.



### DANGER!

Parameter alterations made by non-qualified persons may lead to incorrect depth readings which in turn can lead to material damage and to the loss of life and limb

To call up the **SYSTEM SET-UP MENU**, press the **ENTER** key four times. The **MENU** as shown below will appear.

SYSTEM-SETUP	
Date	05.05.03
Time	12:34
Color Bar	
<b>Service</b>	<b>&gt;&gt;</b>
Version	
<i>Version number and date</i>	

Figure 4-22: System Set-Up Menu

The **SYSTEM SETUP MENU** is used to set the Time and Date and to gain access to the **SERVICE** and **INTERFACE SUB MENUS** to allow the service technician to alter installation and interface parameters (**see above warning**).



#### 4.5.4.1 Changing the Date and Time

To change the system **DATE**, call up the **SYSTEM SETUP MENU** and press the following keys:

- **CURSOR ▼** (1x, to mark the word **Date**)
- **ENTER** (1x, to mark the day setting)
- **CURSOR ▼** or **▲** (to alter the day setting)
- **ENTER** (1x, to confirm selection and jump to the month setting)
- **CURSOR ▼** or **▲** (to alter the month setting)
- **ENTER** (1x, to confirm selection and jump to the year setting)
- **CURSOR ▼** or **▲** (to alter the year setting)
- **ENTER** (1x, to confirm selection)
- **ESCAPE** (2x, to leave the **MENU**)

To change the system **TIME**, call up the **SYSTEM SETUP MENU** and press the following keys:

- **CURSOR ▼** (2x, to mark the word **Time**)
- **ENTER** (1x, to mark the hour setting)
- **CURSOR ▼** or **▲** (to alter the hour setting)
- **ENTER** (to confirm selection and jump to the minutes setting)
- **CURSOR ▼** or **▲** (to alter the minutes setting)
- **ENTER** (1x, to confirm selection)
- **ESCAPE** (2x, to leave the **MENU**)

#### 4.5.4.2 Color Bar Menu

SYSTEM-SETUP	
Date	05.05.03
Time	12:34
Color Bar	
<b>Service</b>	<b>&gt;&gt;</b>
Version	
Version number and date	

Figure 4-23: System Set-Up Menu (Color Bar Menu)

The Color Bar Menu allows user settings according to ambient conditions. Several combinations of echo indication and the overlay of general information are possible according to the following table.

Example: CC B>R means

CC: **C**oloured overlay, **C**oloured echo trace

B>R: **B**lue are weak echoes, **R**ed are strong echoes

CODE						
Letters 1+2	Overlay		Letters 3+4	Echo level		Colours
	Text	Background		High	Low	
CC	Black	Coloured	B>W	White	Black	8 blue to white on black
GC	Grey	Dark grey	B>W	White	Black	8 blue to white on black
GG	Grey	Dark grey	B>W	White	Black	16 grey level on black
GG	Grey	Dark grey	W>B	Black	White	16 grey level on white
CC	Black	Coloured	B>R	Red	Black	16 blue to red on black
GC	Grey	Dark grey	B>R	Red	Black	16 blue to red on black



Installation settings are made within the **SERVICE** and **INTERFACE SUB-MENUS** described in chapter 5 “**INSTALLATION, CARE AND MAINTENANCE**”.

## 5 INSTALLATION, CARE AND MAINTENANCE



### WARNING!

#### Danger for man and machine

The operational safety of the system will be endangered if work is not carried out correctly and/or if unauthorised modifications are made!

- Repair work must be carried out by suitably qualified, trained and authorised specialist personnel (see chapter 1.2.2)!
- The applicable local safety regulations must be strictly adhered to when carrying out maintenance or repair work on the system!

### 5.1 Installation

The display and control unit can be panel-, bulkhead-, deck head- or console mounted. The system is delivered with mounting brackets as specified by the user.

Install the display and control unit in accordance with the relevant section of the Installation Drawing Number EZ 52 603 8001 which is enclosed in chapter 6 "DRAWINGS" of this manual.



**At the mounting place, no direct sun light should influence the visibility of the display. For clear display readings a viewing angle of  $\pm 50^\circ$  perpendicular to the display is recommended.**

The echo sounder performance is limited by the acoustic in-water characteristics. These are mainly influenced by the transducer mounting position, the operating frequency and the efficiency of electrical-acoustical conversion.

The transducer position must be selected in a way that the radiating surface is mounted in an area virtually free of turbulence and air bubbles. The sound waves reflected by any layers of air bubbles or turbulence are so strong, that the sound cannot pass the layers and thus echo sounding is prevented.

Because of this, the transducers should be mounted within the ship's bow area. In case of an existing bow thruster, the transducer must be mounted ahead or below the thruster outlet.



**If mounted behind the bow thruster, the performance of the echo sounder will be degraded by turbulence and air bubbles. Even a total echosounding break down is possible.**

During bow thruster operation, echo sounding is not possible because a wide area around the thruster's outlet is saturated with turbulence and air bubbles.

On ships equipped with a bulb bow, the transducer must be mounted as far as possible ahead, because the bulb generates a layer of air bubbles that heavily reduces the transducer / echo sounder performance.

A transducer mounted in the vicinity of the ship's stern can be operated only while drifting, at the pier or at very low speed. The reason is that the stern area is generally disturbed by turbulence and air bubbles, dependent on ship's speed. In addition, vibrations and engine noise may be a source of disturbances. The sound signal cannot penetrate this layer, the bottom echo fades away and the digital display shows the zero echo (1 - 1.5 m) or "?". Therefore only the front transducer must be used while sailing.

Once the transducer has been installed, the system must be set up to under consideration of several factors:

These are:

- Never paint the radiating surface of the transducer.
- Transducer installation depth beneath the surface.
- Transducer installation height relative to the lowest part of the ship's keel.
- Blocking depth, a setting to prevent false digital depth readings caused by resonance of non-ELAC transducers. **This setting needs not to be altered from ZERO if using ELAC transducers.**
- Frequency of the transducer.
- Installation position of the transducer, e.g. BOW, AFT, Pt., Stb, (if two transducers are installed).

When a transducer is installed, i.e. before the ship is launched, measure the height difference between the radiating surface of the transducer and the lowest part of the keel and the distance between the waterline and the radiating surface of the transducer. These measurements are necessary to compensate the differences when the system is initially set up. The transducer frequency is shown in the shipping documents.

Connect the system in accordance with the connection diagram (see chapter 6).

When cabling the system, take special care that all signal lines are screened properly. The cable from the transducer to the connection box must be laid in a steel pipe.

From the connection box to the echo sounder there are the following choices for a proper cable laying:

- the transducer cable is laid within a steel pipe, that is connected to the ship's ground.
- a double-screened cable is used as transducer cable, the inner screen is one-side connected to the echo sounder's ground, the outer screen is connected to the ship's ground on both sides ( see Figure 5-1).

The transducer cable is laid at least 0,5 m apart from all other cables.

By no means a single-screened cable must be laid together with any other cable.

5.1.1 Transducer – Cable Connection

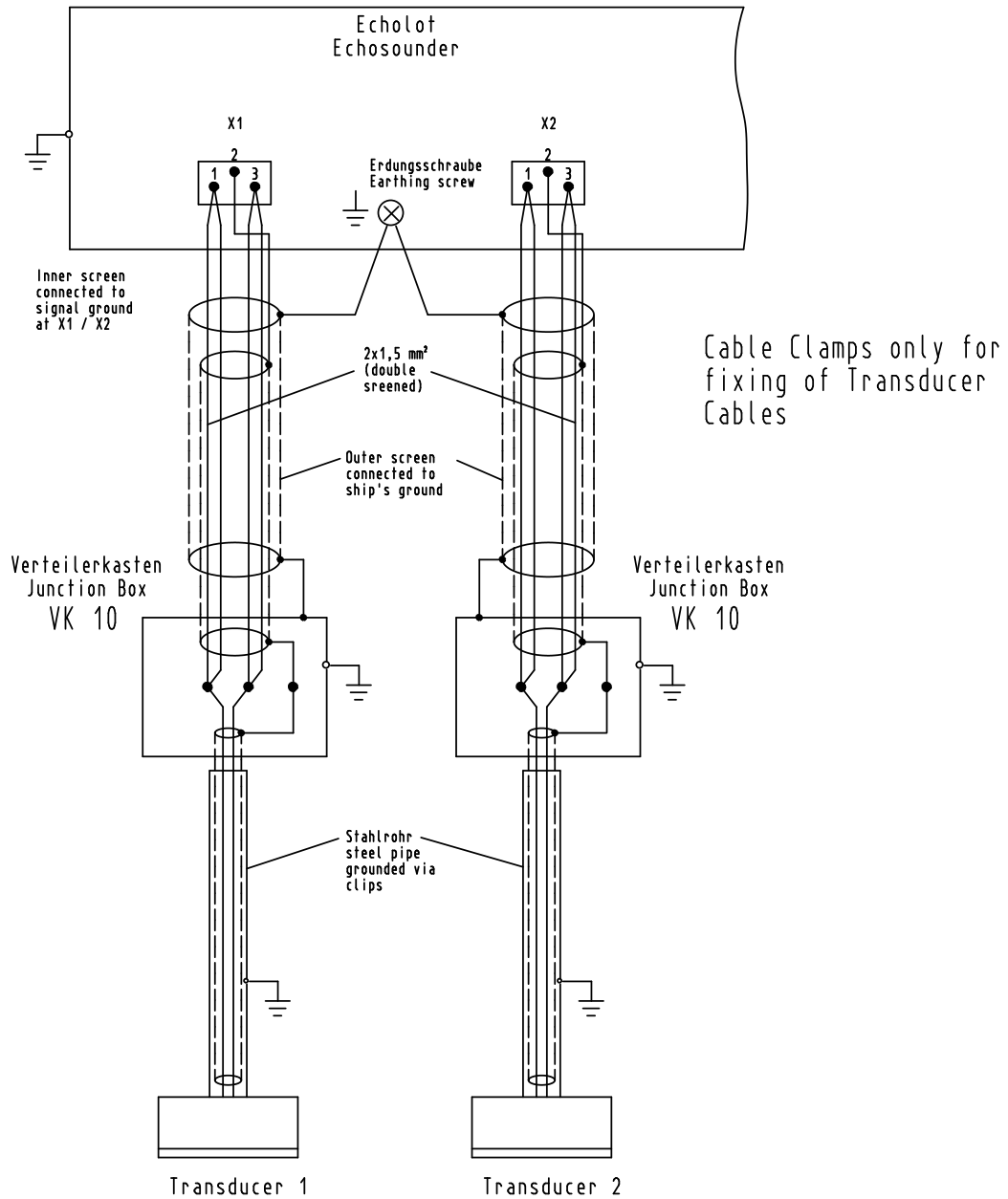

Figure 5-1 Instruction for transducer - cable connection

### 5.1.2 Distortion Level Test

After routing and connecting the transducer cable, a distortion level test must be carried out, to ensure the correct routing and screening of the transducer cables.

**Test procedure:**

1. Switch on the echo sounder
2. Select 500 m range
3. Select Display Gain 10 (max.)
4. Select Display Mode 1/2 for Dual Channel Unit
5. Select Item Gain, man. in the Parameter Menu
6. Select Gain 15 (max.)
7. Check the recording on the LCD screen. Below the transmitting pulse and echo signals no or only a light distortion shall appear on the screen.
8. If a strong distortion appears, check and correct transducer cable routing and screening according to the Installation Instruction.
9. Repeat test procedure until the display is free of distortion.
10. Return to normal mode

Connect peripheral equipment, i.e. external PC, printer, remote display unit etc. in accordance with the above mentioned connection diagram, referring to Figure 3-2 "System Block Diagram (with Options)" in chapter 3.2.1.

### 5.1.3 Transducer Types

The transducers, listed in the table are samples, further types are available and can be connected to ELAC echo sounders.

Transducer Type	Frequency	Manufacturer	Electrical Power	Maximum Cable Length (2x1.5mm <sup>2</sup> )	Maximum Water Depth
LSE 131	30 kHz	ELAC Nautik	1000 Watt	600 m	2000 m
LSE 132	30 kHz	ELAC Nautik	450 Watt	600 m	1000 m
LSE 297	50 kHz	ELAC Nautik	250 Watt	400 m	600 m
LSE 133	50 kHz	ELAC Nautik	450 Watt	600 m	1000 m
LSE 328	100 kHz	SAM	250 Watt	200 m	250 – 300 m
LSE 329	100 kHz	ELAC Nautik	250 Watt	200 m	250 – 300 m
LSE 148	100 kHz	ELAC Nautik	450 Watt	200 m	350 – 400 m
LSE 313	200 kHz	ELAC Nautik	250 Watt	150 m	250 – 300 m
LSE 135	200 kHz	ELAC Nautik	250 Watt	150 m	200 – 250 m

Tab. 9: Transducer type



**The typical maximum water-depths are valid for transducer installation with direct transmitting into the water.**



**For cable lengths longer than the ones mentioned in the table, the electrical power of the echo sounder has to be increased according to manufacturer's release.**

If acoustic windows are installed, the performance can decrease drastically, due to the losses in the passage of the acoustic beam through the fluid between transducer surface and acoustic window and the acoustic window itself.

The losses are minimal, if the distance between transducer surface and acoustic window is  $\lambda/2$  and the acoustic window is parallel to the transducer surface.

For frequencies higher than 50 kHz, acoustic windows generate high losses of performance and should be avoided.

### 5.1.4 Initial System Set-Up

After installation of the Navigation Echo Sounder, please follow this procedure for setting into operation for the first time.

No.	Item	Result
1.	Installation check	
1.1	Main supply (X3)	
1.2	Transducer (X1, X2) – cable screening, cable laying	
1.3	Printer (X7) – max. cable length 5 m	
1.4	NMEA – Output (X8) – RS 422	
1.5	NMEA – Input (X4) – RS 422	
1.6	Start / Stop – Output (X8)	
1.7	NMEA – Output (X6) – RS 422	
2.	Setting into operation	
2.1	Disconnect Printer, NMEA - Input and Output	
2.2	Only Main Supply and Transducer connected	
2.3	Switch the unit “ON”	
2.4	Check and make basically settings	
	- frequency	
	- sound velocity (1,500 m/s)	
	- blocking depth (2 - 2.9 m)	
	- draft, trim	
	- NMEA - Interface (4.800 baud, 8N1)	
	- date and time	
2.5	Check the function of the unit	
	- depth recording	
	- LC - Display	
2.6	Check distortion level	
	- select 500 m range	
	- select item Manual Gain	
	- select gain Vmax (15)	
	- no or a light distortion shall appear on the LCD – screen	
	- reduce gain, until the screen is free of distortion	
	- notice gain level	
	- return to normal mode	
2.7	Connect NMEA - Output (if requested)	
	- check data at receiving unit	
2.8	Connect NMEA - Input (if requested)	
	- check data on LC- Display	
2.9	Connect Printer (if available)	
	- check recording on printer	
2.10	Connect Start/Stop - Output (i.e. DAZ 13) (if requested)	
3.	Sea Trial	
3.1	Check the performance of the transducer	
	- distortion (air bubbles, turbulence) transducer?	
	- recording free of electrical noise?	
	- depth indication, analogue and digital	



Once the system has been correctly installed, the initial set-up can be carried out.

Call the **SYSTEM SET-UP MENU** by pressing the **ENTER** key four (4) times. When the **SYSTEM SET-UP MENU** appears on the display area, press the **CURSOR ▼** key three (3) times so that the word **Service** is highlighted as shown below.

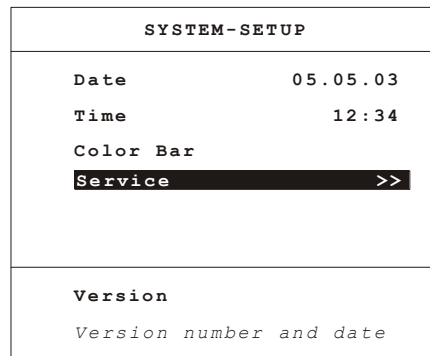

Figure 5-2 System Set-Up Menu

Press the **ENTER** key and the **WARNING** shown below will appear.

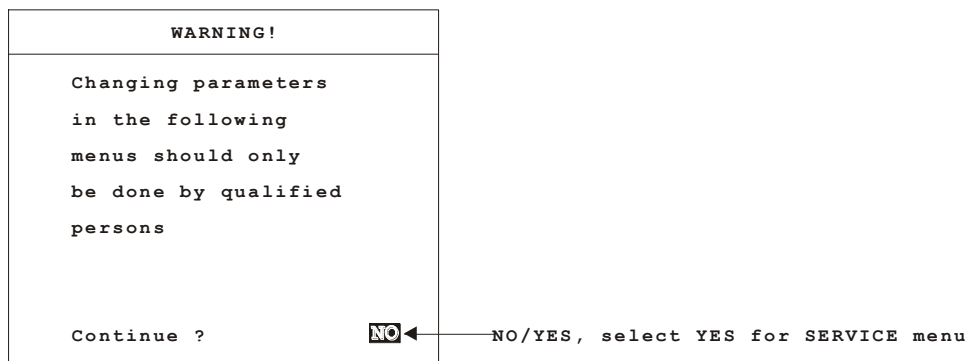

Figure 5-3 System Set-Up Menu (Warning)



### WARNING!

**Only qualified service technicians are allowed to alter these system settings. If you are not authorised to alter these settings, DO NOT continue. Press either the ENTER or ESCAPE key to return to the SYSTEM SET-UP menu.**

**UNAUTHORISED alteration of these settings can endanger the safety of the ship and lead to loss of life and limb. If not authorised to make alterations, press the ESCAPE or ENTER key to return to the SYSTEM SET-UP menu.**

Access to the **SERVICE MENU** is gained by pressing any **CURSOR** key. The word **NO** will change to **YES**. Press the **ENTER** key and the **SERVICE MENU**, shown below, will appear.

SERVICE		
Channel 1	>>	← To call up Channel 1 parameter MENU
Channel 2	>>	← To call up Channel 2 parameter MENU
Interfaces	>>	← To call up interface parameter MENU
Display 15 min	ON	ON - OFF
Power Adjust	Norm	Norm +1dB, +2dB, +3dB, +4dB, +5dB -2dB, -1dB

Figure 5-4 Service Menu

The **SERVICE MENU** allows the service technician to access the following sub-MENUS:

- **Channel 1** : allows selection of Draft, Trim, Blocking Depth, Frequency and Location for the Channel 1 transducer.
- **Channel 2** : allows selection of **Draft, Trim, Blocking Depth, Frequency** and **Location** for the **Channel 2** transducer, if fitted. If no second channel is fitted, this **MENU** is not available
- **Interfaces** : allows selection of parameters for data transfer.
- **Display 15 min** : altering the selection of the recording display time.

In order to set or alter the parameters for Channel 1, call up the CHANNEL 1 MENU, as follows:

- Call up the SERVICE MENU as previously described
- CURSOR ▼ (1x, to mark Channel 1)
- ENTER (1x, to call up the Channel 1 parameters **MENU** as seen below)

CHANNEL 1		
Draft	0.0	← (0.0..29.9 m)
Trim	0.0	← (0.0..4.9 m)
Blocking Depth	0.0	← (0.0..2.9 m)
Frequency	50	← (24, 28, 33, 38, 50, 100, 200 kHz)
Location	BOW	← (BOW, AFT, Stb., Pt.)

Figure 5-5 Channel 1 Menu

The **CHANNEL 1 MENU** allows the service technician to set the following parameters:

- **Draft:** the transducer installation depth is entered here, i.e. the depth of the transducer below the waterline, e.g. 5.6 m. This compensation allows accurate surface to sea bed measurements.
- **Trim:** the distance between the transducer and the lowest part of the keel is entered here, e.g. 0.3 m. This compensation allows accurate keel to sea bed measurements.
- **Blocking depth:** this setting prevents false digital depth readings caused by the effects of resonance of non-ELAC transducers. If the water depth is less than the depth set here, the digital display will show a „?“ but the analogue depth reading will be displayed correctly.
- **Frequency:** the transducer working frequency is entered here, e.g. 50 kHz.
- **Location:** the position where the transducer is installed is entered here, e.g. BOW.



**This parameter is not available for single channel systems!**

To alter the **Draft** setting, press the following keys:

- Call up the **CHANNEL 1 SUB MENU** as described previously
- **CURSOR ▼** (1x, to mark the word **Draft**)
- **ENTER** (1x, to mark the 1st digit)
- **CURSOR ▼** or **▲** (to alter the metre (1st digit) setting)
- **ENTER** (1x, to confirm selection and jump to 2nd digit)
- **CURSOR ▼** or **▲** (to alter the 1/10th of a metre (2nd digit) setting)
- **ENTER** (1x, to confirm selection)
- **ESCAPE** (2x, to leave the **MENU**)

To alter the **Trim** setting, press the following keys:

- Call up the **CHANNEL 1 SUB MENU** as described previously
- **CURSOR ▼** (2x, to mark the word **Trim**)
- **ENTER** (1x, to mark the 1st digit)
- **CURSOR ▼** or **▲** (to alter the metre (1st digit) setting)
- **ENTER** (1x, to confirm selection and jump to 2nd digit)
- **CURSOR ▼** or **▲** (to alter the 1/10th of a metre (2nd digit) setting)
- **ENTER** (1x, to confirm selection)
- **ESCAPE** (2x, to leave the **MENU**)

To alter the **Blocking Depth** setting, press the following keys:

- Call up the **CHANNEL 1 SUB MENU** as described previously
- **CURSOR ▼** (3x, to mark the word **Blocking Depth**)
- **ENTER** (1x, to mark the 1st digit)
- **CURSOR ▼** or **▲** (to alter the metre (1st digit) setting)
- **ENTER** (1x, to confirm selection and jump to 2nd digit)
- **CURSOR ▼** or **▲** (to alter the 1/10th of a metre (2nd digit) setting)
- **ENTER** (1x, to confirm selection)
- **ESCAPE** (2x, to leave the **MENU**)

To alter the **Frequency** setting, press the following keys:

- Call up the **CHANNEL 1 SUB MENU** as described previously
- **CURSOR ▼** (3x, to mark the word **Frequency** )
- **ENTER** (1x, to mark the frequency selected e.g. 200)
- **CURSOR ▼** or **▲** (to alter the setting)
- **ENTER** (1x, to confirm selection)
- **ESCAPE** (2x, to leave the **MENU**)



The new setting can only be activated by re-starting the system (i.e. switch the system OFF and then ON again).

To alter the Location setting, press the following keys:

- Call up the **CHANNEL 1 SUB MENU** as described previously
- **CURSOR ▼** (5x, to mark the word **Location** )
- **ENTER** (1x, to mark the location selected e.g. BOW)
- **CURSOR ▼** or **▲** (to alter the setting)
- **ENTER** (1x, to confirm selection)
- **ESCAPE** (2x, to leave the **MENU**)

In order to set or alter the parameters for Channel 2, call up the CHANNEL 2 MENU, as follows:

- Call up the **SERVICE MENU** as previously described
- **CURSOR ▼**(2x, to mark **Channel 2**)
- **ENTER** (1x, to call up the Channel 1 parameters **MENU** as shown below)

CHANNEL 1	
Draft	0.0 ← (0.0...29.9 m)
Trim	0.0 ← (0.0...4.9 m)
Blocking Depth	0.0 ← (0.0...2.9 m)
Frequency	50 ← (24, 28, 33, 38, 50, 100, 200 kHz)
Location	BOW ← (BOW, AFT, Stb., Pt.)

Figure 5-6 Channel 2 Menu

Proceed from here in exactly the same way as described for **Channel 1**.

To call up the INTERFACE MENU proceed as follows:

- Call up the **SERVICE MENU** as described previously
- **CURSOR ▼** (3x, to mark the word Interfaces)
- **ENTER** (1x, to call up the INTERFACES SUB-MENU)

The **INTERFACE MENU** shown below will appear.

INTERFACES	
<b>External PC</b>	
Mode	8N1 ← (7E1, 7E2, 8N1, 8E1, 8N2, 8E2)
Baud	19200 ← (1200, 2400, 4800, 9600, 19200, 38400 Baud)
<b>NMEA/DAZ 25</b>	
Mode	8N1 ← (7E1, 7E2, 8N1, 8E1, 8N2, 8E2)
Baud	4800 ← (1200, 2400, 4800, 9600, 19200, 38400 Baud)
Rep. rate	SLOW ← (SLOW, FAST)
Protocol	DPT/DBT ← (DPT/DBT, ELAC)

Figure 5-7: Interface Menu

This menu allows the service technician to adjust the interfaces to fit to other peripheral equipment, e.g. a personal computer or digital slave indicators.

To alter the External PC Mode, press the following keys:

- Call up the **INTERFACES SUB-MENU** as described previously
- **CURSOR ▼** (1x, to mark the word **Mode**)
- **ENTER** (1x, to mark the selected mode)
- **CURSOR ▼** or **▲** (to alter the mode)
- **ENTER** (1x, to confirm selection)
- **ESCAPE** (2x, to leave the **MENU**)

To alter the External PC Baud rate, press the following keys:

- Call up the **INTERFACES SUB-MENU** as described previously
- **CURSOR ▼** (2x, to mark the word **Baud**)
- **ENTER** (1x, to mark the selected Baud rate)
- **CURSOR ▼** or **▲** (to alter the Baud rate)
- **ENTER** (1x, to confirm selection)
- **ESCAPE** (2x, to leave the **MENU**)

To alter the NMEA/DAZ 25 Mode, press the following keys:



#### **WARNING!**

The NMEA/DAZ 25 interface Mode and Baud rate are defined by the National Marine Electronics Association. If these are altered, the interface will no longer correspond to this NMEA standard.

- Call up the **INTERFACES SUB-MENU** as described previously
- **CURSOR ▼** (3x, to mark the word **Mode**)
- **ENTER** (1x, to mark the selected mode)
- **CURSOR ▼** or **▲** (1x, to alter the mode)
- **ENTER** (1x, to confirm selection)
- **ESCAPE** (2x, to leave the **MENU**)

To alter the NMEA/DAZ 25 Baud rate, press the following keys:

- Call up the **INTERFACES SUB-MENU** as described previously
- **CURSOR ▼** (5x, to mark the word **Baud**)
- **ENTER** (1x, to mark the selected Baud rate)
- **CURSOR ▼** or **▲** (to alter the Baud rate)
- **ENTER** (1x, to confirm selection)
- **ESCAPE** (2x, to leave the **MENU**)

To alter the Protocol, press the following keys:

- Call up the **INTERFACES SUB-MENU** as described previously
- **CURSOR ▼** (6x, to mark the word **Protocol**)
- **ENTER** (1x, to mark the selected Protocol)
- **CURSOR ▼** or **▲** (to alter the Protocol)
- **ENTER** (1x, to confirm selection)
- **ESCAPE** (2x, to leave the **MENU**)



**Note, that the Protocol ELAC is only applicable for dual channel units, see also chapter 0 Description of Interfaces.**

To alter the recording display time on the LCD – Screen, press the following keys

- Call up the **Display 15 min Sub Menu** as described previously
- **Enter** (1x), to mark “ON” or “OFF”
- **Cursor** to alter the setting
- **Enter** (1x), to confirm the selection
- **Escape**(2x), to leave the **Menu**

Once the initial system settings have been made they need only be altered if for example a second transducer is added or if the original transducer is replaced with one of a different frequency.

If a second transducer is added at a later date, parameters must be entered in the channel 2 sub-menu. The parameters for channel 1 must not be altered. (See installation instruction UN 52 590 4001 for the integration of the second channel).

If the original transducer is replaced and the replacement is fitted at a different location, the parameters must be altered accordingly.

### 5.1.5 Power Adjust

This adjust feature allows the authorised service person to alter the transmitting power according to cable length on board.

## 5.2 Care and Maintenance

The Navigation Echo Sounder is largely maintenance free.

The transducer(s) should be cleaned whenever an opportunity arises, e.g. when the ship is in dock. The transducer(s) can be cleaned with a plastic scraper or scrubbing brush, see note below.



**Never use metal scrapers or wire brushes to clean the transducer(s). Never paint the radiating surface of the transducer(s).**

The housing of the control and display unit can be cleaned using a non-abrasive household cleaning agent. Use window/glass cleaning fluid to clean the display area screen.



**Do not apply unnecessary pressure to the screen when cleaning.**

If the systems cables are exposed, i.e. are not run in ducts or tubes, check them at monthly intervals for insulation damage.

If the system is defective and requires repair, onboard service is normally not possible because of the high density electronics.

For support and ordering of spares contact the address below stating part(s) required and identification number(s).



L-3 Communications ELAC Nautik GmbH  
Manufacturer code: D1876

Neufeldtstraße 10  
24118 Kiel  
Germany

☎: ++49 (0)431 883-388

✉: ++49 (0)431 883-366

@: elac.support@l-3com.com



**6 DRAWINGS**

Designation	ELAC Document No.	Comment
Dimensional drawing Echo Sounder LAZ 5100	MB 52 603 8001	
Installation drawing Echo Sounder LAZ 5100	EZ 52 603 8001	
Circuit diagram	SP 52 603 8001	
Connection Diagram	VE 44 395 8001	
Cable Joining List	KA 44 395 8001	

Tab. 10: Drawings



APPENDIX

**7 APPENDIX**

**7.1 Installation – Report**

Installation – Report

Schiffsname

Ship's name \_\_\_\_\_

Installationsfirma

Installation Company \_\_\_\_\_

Installationsdatum

Date of Installation \_\_\_\_\_

LAZ 5100  ES 5100

Werk-Nr. (S/N) 1-Kanal – Gerät 2-Kanal – Gerät  
 Serial Number \_\_\_\_\_ 1-channel unit  2-channel unit

Wandlertyp

Transducer Type \_\_\_\_\_ S/N \_\_\_\_\_

Digitale Tochteranzeige

Digital Display Unit DAZ 25   
 S/N \_\_\_\_\_ S/N \_\_\_\_\_

Einstellungen	LAZ 5100 / ES 5100	Kanal 1	Kanal 2
Settings		Channel 1	Channel 2
Frequenz / Frequency		_____	_____
Blocking Depth		_____	_____
Draft		_____	_____
Trim		_____	_____
Location		_____	_____
NMEA - Interface		_____	_____
Baud rate		_____	_____
Mode		_____	_____
Repetition Rate		_____	_____
Protocol		_____	_____

Bitte eine Kopie des Installationsreports an ELAC Nautik Service Centre schicken.

Please forward a copy of the Installation Report to ELAC Nautik Service Centre.

Fax + 49 431 883 366

## 7.2 Service–Anforderung / Service Request

Service–Anforderung / Service Request

LAZ 5100

ES 5100

Werk – Nr.

Serial Number

Schiffsname:

Schiffsfax:

Ship's Name: \_\_\_\_\_

Ship's Fax: \_\_\_\_\_

### Checklist for System Parameter Setting

No.	Item	Default value	Actual value
1.	Menu „Alarm“		
1.1	Alarm ↗	„OFF“	
1.2	Alarm depth ↗	„0000“	
1.3	Alarm ↘	„OFF“	
1.4	Alarm depth ↘	„0000“	
2.	Menu „Parameter“		
2.1	Channel Select	1; 1/2; 2	
2.2	Sound velocity	1500 m/s	
2.3	Units	m	
2.4	Depth mode	DBK	
3.	Menu „Log data“	no default value	
4.	Menu „System Set Up“		
4.1	Date, Time	actual date, time	
4.2	Service	select with yes	
4.2.1	Channel 1		
4.2.1.1	Draft	0,0 m	
4.2.1.2	Trim	0,0 m	
4.2.1.4	Blocking Depth	2 - 2,5 m	
4.2.1.4	Frequency	xx kHz (depends on transducer)	
4.2.1.5	Location	BOW	
4.2.2	Channel 2 (if included)		
4.2.2.1	Draft	0,0 m	
4.2.2.2	Trim	0,0 m	
4.2.2.3	Blocking Depth	2 - 2,5 m	
4.2.2.4	Frequency	xx kHz (depends on transducer)	
4.2.2.5	Location	AFT	

APPENDIX

4.3.3	Interface		
4.3.3.1	External PC	38400 ; 8N1	
4.3.3.2	NMEA / DAZ 25	4800 ; 8N1	
4.3.3.3	Repetition Rate	Fast / Slow	
4.3.3.4	Protocol	DPT/DBT or ELAC	
4.4	Color Bar Menu	CCBR	

Please return filled check list to ELAC Nautik / Fax +49 431 883 366

Fehlerbeschreibung / Fault Description

## 7.3 Certificates



ELAC Nautik

### EC-Declaration of Conformity

**In accordance with the Marine Equipment Directive 96/98/EC modified by  
Commission Directive 2010/68/EC of 22. Oct. 2010**

we herewith declare that the following product is in accordance with the design described in EC Type Examination (Module B) Certificate No. BSH/4612/4061453/09 and produced and tested in accordance with the Quality System (Modul D) as certified by Germanischer Lloyd Certificate No. 37 961 – 12 HH.

In case of alteration of the product without our agreement, this declaration loses its validity.

**Manufacturers name:**

L-3 Communications ELAC Nautik GmbH  
Neufeldtstrasse 10  
D-24118 Kiel  
Tel.: +49 (0) 431 883-0

**Description of the electrical equipment:**

- function: Echo-sounding equipment
- type/model: ELAC Navigation Echo Sounder LAZ 5100
- part number: 52 603 8001; 52 603 8002



This declaration is valid for all units manufactured according to the actual valid production drawings at the issuing date of this declaration.

**Reference to the applied standards:**

- ISO 9875 Ed.3.0, 2000
- IEC 60945 Ed. 4.0, 2002
- IEC 61162-1 Ed. 3.0, 2007
- IEC 62288 Ed. 1.0, 2008

**Place/Date:** Kiel, July 15, 2012

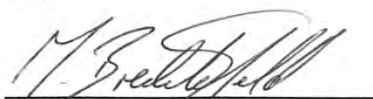
**Signature:**  
(name, position)

  
Dr. Jörg Brechtefeld (Ph.D.), General Manager  
i. A. Hans-Hermann Lund; CE- Coordinator



ELAC Nautik

## EC-Declaration of Conformity

**In accordance with the Marine Equipment Directive 96/98/EC modified by  
Commission Directive 2010/68/EC of 22. Oct. 2010**

we herewith declare that the following product is in accordance with the design described in EC Type Examination (Module B) Certificate No. BSH/4612/4061348/09 and produced and tested in accordance with the Quality System (Modul D) as certified by Germanischer Lloyd Certificate No. 37 961 – 12 HH.

In case of alteration of the product without our agreement, this declaration loses its validity.

**Manufacturers name:**

L-3 Communications ELAC Nautik GmbH  
Neufeldtstrasse 10  
D-24118 Kiel  
Tel.: +49 (0) 431 883-0

**Description of the electrical equipment:**

- function: Echo-sounding equipment
- type/model: Sperry Navigation Echo Sounder ES 5100
- part number: 52 603 8001; 52 603 8002

This declaration is valid for all units manufactured according to the actual valid production drawings at the issuing date of this declaration.

**Reference to the applied standards:**

- ISO 9875 Ed.3.0, 2000
- IEC 60945 Ed. 4.0, 2002
- IEC 61162-1 Ed. 3.0, 2007
- IEC 62288 Ed. 1.0, 2008

**Place/Date:** Kiel, July 15, 2012

**Signature:**  
(name, position)



Dr. Jörg Brechtfeld (Ph.D.), General Manager



i. A. Hans-Hermann Lund; CE- Coordinator

