

DATA RECORDING SOFTWARE FOR PC

(FE-700 Optional Kit)

This application software is used for collecting data of date, time, depth, draft, latitude, longitude, speed and course from the Navigational Echo Sounder FE-700. The interconnection between the FE-700 and PC is as follows.

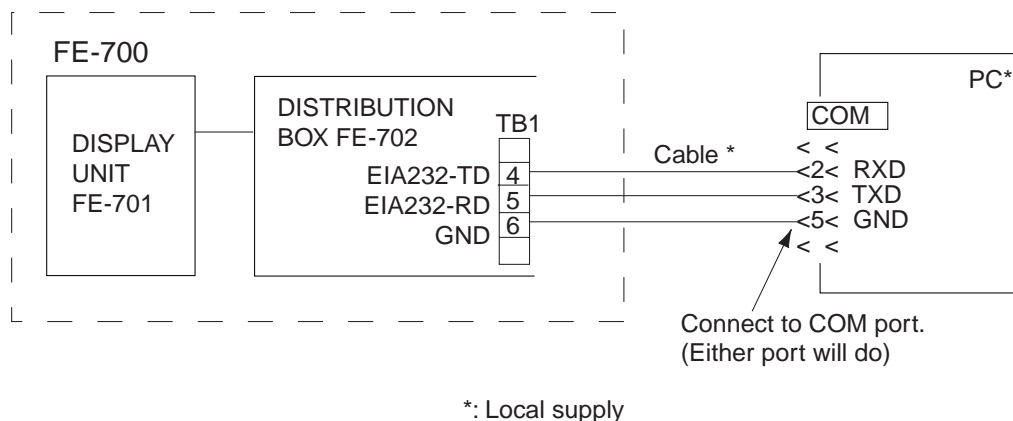

Figure 1 Interconnection between FE-700 and PC

1. INSTALLATION

1.1 Installing the program

System Requirements

The DATA RECORDING SOFTWARE FOR PC runs under Windows 2000/XP/Vista, and also 128 MB and more of RAM are recommended.

Procedure

1. Insert the program floppy disk supplied with the DATA RECORDING SOFTWARE FOR PC kit into your floppy disk drive.
2. Double-click the floppy disk drive icon to display files in the floppy disk.
3. Double-click the **Setup.exe** icon. The installation program starts and guides you through the installation process.
4. Follow the instructions displayed on the screen. DATA RECORDING SOFTWARE FOR PC will be installed C:\Users\Public\FURUNO\FE700 on default.
5. Keep your original floppy disk in a safe place.



1.2 Setting up the program

1. Click the **START** button on the Windows to open the Start menu.
2. Move the mouse pointer on the **PROGRAM** option to open the Program menu.
3. Move the mouse pointer on the **Fe700** option. The application menu opens.
4. Move the mouse pointer on the application program icon **Fe700** and click it. The DATA RECORDING SOFTWARE FOR PC will start up. The following screen appears.

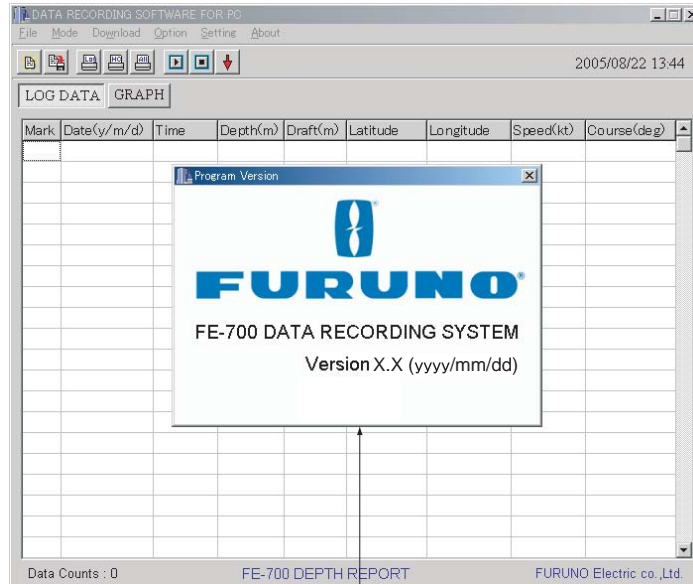

Version information display (displayed three seconds)

Figure 2 Start-up Display

1.3 Setting the serial port

1. Select **Setting-Serial port** from the menu bar.

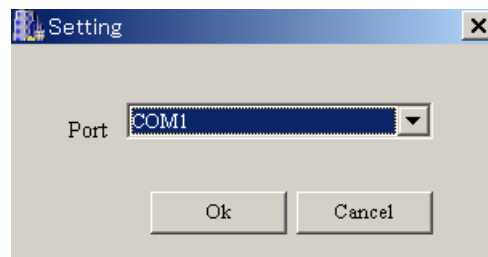

2. Select the port (COM 1 to COM 9) which has been connected to the PC.
3. Press OK button.

2. OPERATION PROCEDURES

Note: If you open the system menu 1, 2 or 3 of the FE-700 during downloading, "Communication error!" will appear. Press the **OK** button and repeat from beginning.

2.1 Downloading data

To download real time data (one second intervals data) from the FE-700, press the **Start** button  on the toolbar, or select **Download - Start** from the menu bar. Also, pressing **F9** key on your keyboard downloads real time data. The data is downloaded at one second intervals and displayed in log (Log mode) or graph (Graph mode) form.

Mark	Date(y/m/d)	Time	Depth(m)	Draft(m)	Latitude	Longitude	Speed(kt)	Course(deg)
	2005/08/03	15:14:06	020.8	-10.0	35 00.08' N	134 59.92' E	18.1	173.0
	2005/08/03	15:14:07	020.0	-10.0	35 00.08' N	134 59.92' E	18.5	173.2
	2005/08/03	15:14:08	019.3	-10.0	35 00.08' N	134 59.92' E	18.9	173.4
	2005/08/03	15:14:09	018.7	-10.0	35 00.08' N	134 59.92' E	19.3	173.6
	2005/08/03	15:14:10	018.3	-10.0	35 00.08' N	134 59.92' E	19.7	173.8
	2005/08/03	15:14:11	018.0	-10.0	35 00.08' N	134 59.92' E	20.1	174.0
	2005/08/03	15:14:12	017.4	-10.0	35 00.08' N	134 59.92' E	20.5	174.2
	2005/08/03	15:14:13	017.1	-10.0	35 00.08' N	134 59.92' E	20.7	174.3
M	2005/08/03	15:14:14	016.9	-10.0	35 00.08' N	134 59.92' E	21.3	174.6
	2005/08/03	15:14:15	017.0	-10.0	35 00.08' N	134 59.92' E	21.7	174.8
	2005/08/03	15:14:16	017.0	-10.0	35 00.08' N	134 59.92' E	22.1	175.0
	2005/08/03	15:14:17	017.2	-10.0	35 00.08' N	134 59.92' E	22.5	175.2
	2005/08/03	15:14:18	018.4	-10.0	35 00.08' N	134 59.92' E	22.9	175.4
	2005/08/03	15:14:19	019.0	-10.0	35 00.08' N	134 59.92' E	22.9	175.6
	2005/08/03	15:14:20	020.1	-10.0	35 00.08' N	134 59.92' E	22.5	175.8
	2005/08/03	15:14:21	021.4	-10.0	35 00.08' N	134 59.92' E	22.1	176.0
	2005/08/03	15:14:22	024.9	-10.0	35 00.08' N	134 59.92' E	21.7	176.2
	2005/08/03	15:14:23	027.4	-10.0	35 00.08' N	134 59.92' E	21.3	176.4
	2005/08/03	15:14:24	028.2	-10.0	35 00.08' N	134 59.92' E	20.9	176.6
	2005/08/03	15:14:25	029.4	-10.0	35 00.08' N	134 59.92' E	20.5	176.8

Figure 3 Log Mode (text screen)

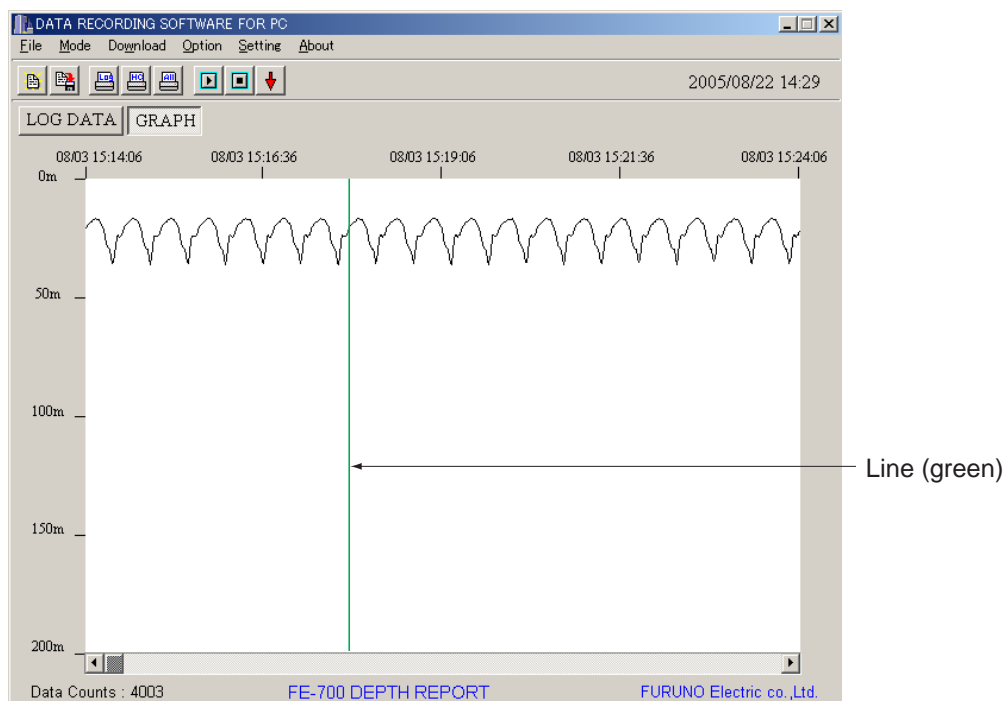



Figure 4 Graph Mode (graphic screen)

To change the mode, press the **LOG DATA** or **GRAPH** button on the screen or select **Mode – Log Data / Graph** from the menu bar. Also, pressing **F7** key or **F8** key on your keyboard changes the mode to log mode or graph mode, respectively.

To inscribe line (s) on the graphic screen, click the **Mark** button  on the toolbar, or select **Option-Mark** from the menu bar (or **F1** key) at the moment you want to pay attention. **M** mark is displayed on the text screen.

To stop downloading at any time, press the **Stop** button  on the toolbar or select **Download - Stop** from the menu bar. Also, pressing **F10** key on your keyboard stops downloading.

2.2 Downloading RAM data in the FE-700

To download one hour of data (one second intervals data) or 24 hours of data (five seconds intervals data) in the RAM of the FE-700 (accumulated at the Echo Sounder FE-700), select **Download - Loading Option - 1h Data** or **24h Data**. The Download dialog box appears, showing "Now downloading" and indicating data volume. You can cancel downloading at any time by selecting **Cancel**.

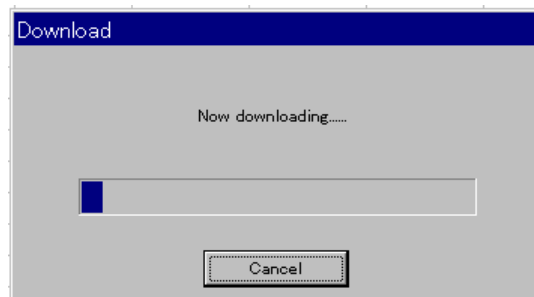

Figure 5 Download dialog box

When downloading is completed, "Download Completed" is shown. Click the **OK** button. The downloaded data is saved at a file named after date of the moment you just start downloading. For example, one hour data file is named as "20000717_1h.dat". (This file has created at July 17, 2000.) When you open the file from the **FILE** menu, you can observe the data in the log mode.

2.3 Setting option items

The **Option** menu provides various settings for downloading real time data or depicting graphics.

To open the **File** dialog box, select **Option - Option** on the menu bar. Click the **File** tab if it is not already selected. The **File** dialog box appears.

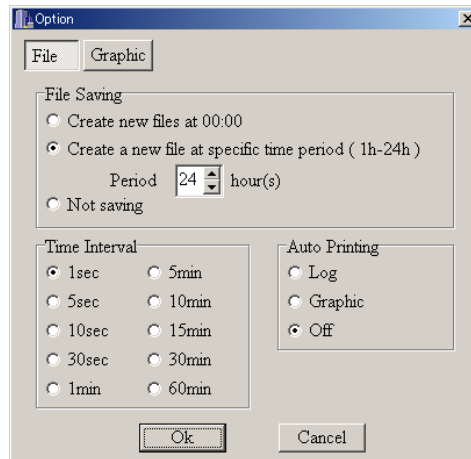

Figure 6 File tab on the Option dialog box

File Saving option

Create new files at 00:00:

New files will be automatically created every day at 00:00. (Initial file is created when the **Start** button is pressed.) Files will be named as “yyyymmdd” (year+month+day).

Create a new file at specific time period (1h - 24h):

A new file is created and data is saved at a period of specified time (hour). Set hour(s) between 1 and 24 hours at 1-hour period. If you set one hour, for example only the recent one hour data is saved and old data is overwritten. The file is named as “userfile.dat”.

Not saving:

Data received from the FE-700 is displayed on the screen, but not saved to the hard disk of the PC.

Time Interval option

Select time interval to extract received data. Extracted data is displayed on the text screen or graphic screen.

Auto Printing option

Log: Printing is automatically performed every 60 lines of text data.

Graphic: Printing is automatically performed every graphic page.

Off: No automatic printing.

To change a setting, press appropriate radio buttons or press up/down arrow button. After setting as desired, press the **OK** button. The dialog box closes.

To open the **Graphic** dialog box, select **Option - Option** on the menu bar and click the **Graphic** tab if it is not already selected. The **Graphic** dialog box appears.

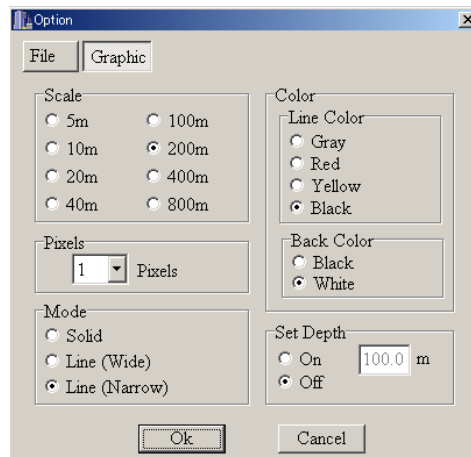

Figure 7 Graphic tab on the Option dialog box

Scale option: Select an appropriate depth scale for graphics, between 5 m to 800 m.

Pixels option: Select appropriate number of pixels to display per one received data from the dropdown list to depict the contour of the seabed. The choices are 1, 2, 5 and 10 pixels.

Mode option: Select the drawing method for graphics among Solid, Line (Wide) and Line (Narrow).

Line Color option: Select seabed color for graphics among gray, red, yellow and black.

Back Color option: Select background color for graphics, between black and white.

Set Depth option: Select Off to display all depth data. Select On to display depth data which is shallower than depth setting. For On, set the depth you wish to display. A red line (blue when “Line Color” is set for “Red”) appears at set depth position.

To change a setting, press appropriate radio buttons or press down-arrow button. After setting as desired completed, press the **OK** button. The dialog box closes.

2.4 Opening a file

There are two methods to open a file: **File** option and **Time Selection** option.

To open a file and display it on the text screen, select the **File - Open** from the menu bar (or Ctrl +O) or click **File Open** button .

The normal Windows **Open File** dialog box appears. Select an appropriate file and click the **Open** button and the **Select Data** dialog box appears. The Select Data dialog box lets you specify which data to read in. After choosing data, click the **OK** button. The data is displayed in the log or graph mode.

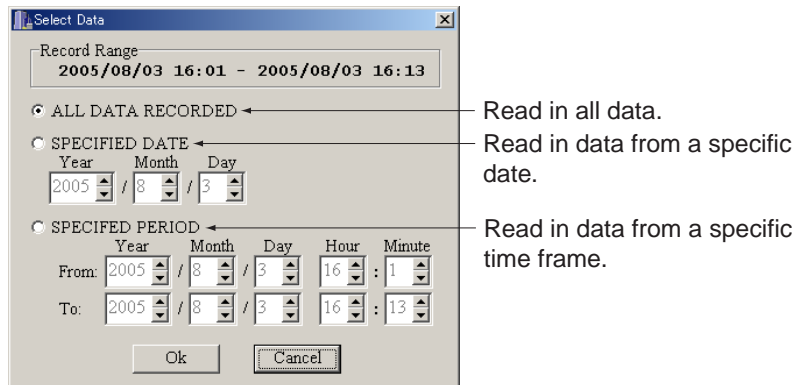

Figure 8 Select Data dialog box

Note: No data is denoted with a black double line. The color is light-blue when there is no data for more than one day.

To read data from specified start date/time to end date/time and display it on the text or graphic screen, select **File - Time Selection** from the menu bar. The **Time Selection** dialog box appears. Enter start date/time and end date/time, then click the **OK** button. You can display the time selection data on the text screen or graphic screen. (In this method, the 1h-data file (xxxxxxx-1h.dat), 24h-data file (xxxxxxx-24h.dat) and userfile.dat can not be opened.)

You can set the from/to period for maximum 11 hours 59 minutes.

Example: From Year 2000/Month 7/Day 5/Hour 13/Minutes 1
To Year 2000/Month 7/Day 6/Hour 1/Minutes 0

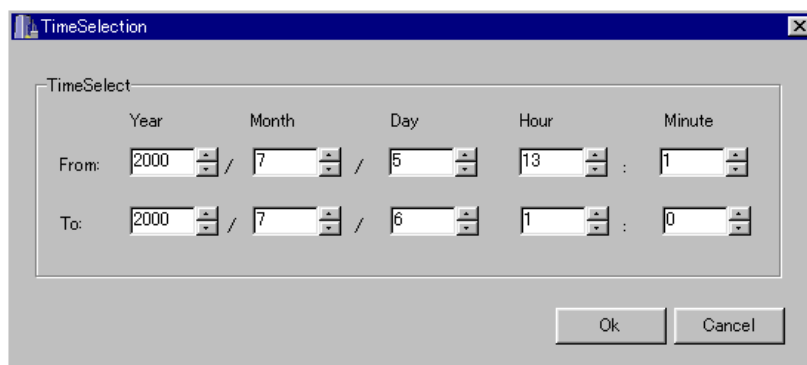



Figure 9 Time Selection dialog box

2.5 Saving a file

Data can be saved with any name in Excel format. Select **File - Save as CSV-file** from the menu bar or click the **Save as CSV-file** button . The normal Windows **Save as** dialog box appears. Type file name, select the location to save and click the **OK** button.

2.6 Printing a file

You may print out data. Select **File - Print** from the menu bar and then click one of the following depending on your objective. The normal Windows **Print** dialog box appears. Click the **OK** button to print out the data.

Log Data: Print log mode data. This can also be done by clicking **Print Log Data** button .

Graph (Hardcopy): Print graph mode data. This can also be done by clicking **Print Graph Hardcopy** button .

Graph (All Data): Compress all graph data into one page and print. This can also be done by clicking **Print Graph All Data** button .

2.7 Displaying version information

Select **About – Program Version** from the menu bar to show the version information, see Figure 2 in section 1.2. To close the display, click the **OK** button.

2.8 Exiting the program

Select **File – Program Exit** from the menu bar. The program closes and return to the Windows screen.

2.9 Error Messages

Below is a list of error messages shown on the screen.

Message	Meaning	Remedy
Initializing error!: COM	Failed initialization of COM port. For example, other application uses COM port.	Match the “serial port” setting (section 1.3) with the COM port connection of the PC.
Communication error!	Failed communication with FE-700.	Confirm the connection between FE-700 and COM port of PC.
Can not open!	Could not read or save data.	No data
Not enough memory to save!	There was not enough space on the hard disk on the PC.	Delete unnecessary files.
Invalid data!	Specified time was wrong.	Try to specify date/time again. (less than 12 hours).
Not found the data!	There was no data in the file at specified time.	Try to specify date/time again.

