

FURUNO

OPERATOR'S MANUAL

*VOYAGE DATA RECORDER
SIMPLIFIED VOYAGE DATA RECORDER*

VR-3000

MODEL VR-3000S

ECF

(Elemental Chlorine Free)

The paper used in this manual
is elemental chlorine free.

FURUNO ELECTRIC CO., LTD.

9-52 Ashihara-cho,
Nishinomiya, 662-8580, JAPAN

Telephone : +81-(0) 798-65-2111

Fax : +81-(0) 798-65-4200

• FURUNO Authorized Distributor/Dealer

All rights reserved. Printed in Japan

Pub. No. OME-44370-G1

(TATA) VR-3000/3000S

A : APR. 2006

G1 : NOV. 24, 2010



* 0 0 0 1 5 7 0 7 8 1 6 *

IMPORTANT NOTICES

General

- The operator of this equipment must read and follow the descriptions in this manual. Wrong operation or maintenance can cancel the warranty or cause injury.
- Do not copy any part of this manual without written permission from FURUNO.
- If this manual is lost or worn, contact your dealer about replacement.
- The contents of this manual and equipment specifications can change without notice.
- The example screens (or illustrations) shown in this manual can be different from the screens you see on your display. The screens you see depend on your system configuration and equipment settings.
- Save this manual for future reference.
- Any modification of the equipment (including software) by persons not authorized by FURUNO will cancel the warranty.
- All brand and product names are trademarks, registered trademarks or service marks of their respective holders.

How to discard this product

Discard this product according to local regulations for the disposal of industrial waste. For disposal in the USA, see the homepage of the Electronics Industries Alliance (<http://www.eiae.org/>) for the correct method of disposal.

How to discard a used battery

Some FURUNO products have a battery(ies). To see if your product has a battery, see the chapter on Maintenance. Follow the instructions below if a battery is used. Tape the + and - terminals of battery before disposal to prevent fire, heat generation caused by short circuit.

In the European Union

The crossed-out trash can symbol indicates that all types of batteries must not be discarded in standard trash, or at a trash site. Take the used batteries to a battery collection site according to your national legislation and the Batteries Directive 2006/66/EU.

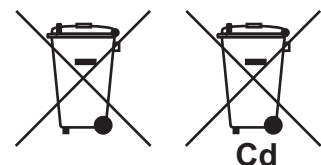

In the USA

The Mobius loop symbol (three chasing arrows) indicates that Ni-Cd and lead-acid rechargeable batteries must be recycled. Take the used batteries to a battery collection site according to local laws.

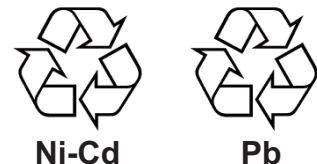

In the other countries

There are no international standards for the battery recycle symbol. The number of symbols can increase when the other countries make their own recycling symbols in the future.

SAFETY INSTRUCTIONS

WARNING



ELECTRICAL SHOCK HAZARD
Do not open the equipment.

Only qualified personnel should work inside the equipment.

Do not disassemble or modify the equipment.

Fire, electrical shock or serious injury can result.

Immediately turn off the power (BATTERY, DC and AC switches in that order) at the DCU and also turn off the power at the ship's mains switchboard if water leaks into the equipment or the equipment is emitting smoke or fire.

Continued use can cause fatal damage to the equipment.

Only authorized personnel shall disassemble the DRU.

Pressure may build up inside the unit when it is subjected to fire or is retrieved from a great depth.

Do not allow rain or water splash to contact the equipment.

Fire or electrical shock can result.

WARNING LABELS

Warning labels are attached to the DCU. Do not remove the labels. If the label is missing or damaged, contact a FURUNO agent or dealer about replacement.

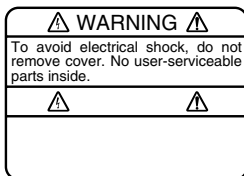

Name: Warning Label 1
Type: 86-003-1011-2
Code No.: 100-236-232-10

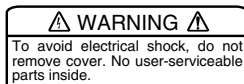

Name: Warning Label 2
Type: 03-129-1001-2
Code No.: 100-236-742-10

WARNING

Do not disassemble the battery.

Battery fluid is harmful to the eyes and skin, particularly the eyes. If the fluid contacts skin or eyes, flush area with fresh water and contact a physician immediately.

Do not dispose of the battery or acoustic beacon in fire.

Those components may burst if disposed of in fire. Further, dispose of the battery in accordance with appropriate regulations.

Do not touch any electrically conductive parts.

Touching electrically conductive parts can result in electrical shock. Use rubber gloves, etc. when conducting inspection or maintenance work.

Do not short battery terminals.

Short can lead to bursting or fire.

CAUTION

Do not:

- use batteries of different capacities
- mix old batteries with new
- mix batteries of different makes

Batteries themselves may become damaged or damage to electrical parts may result.

POWERING DATA COLLECTING UNIT

On the power control panel in the Data Collecting Unit (DCU), confirm that the status display shows “- - -” and the NORMAL LED is lit after the power has been on for two minutes. If not, see Chapter 3.

Procedure for turning on power

1. Turn the AC breaker switch on.
2. Turn the DC breaker switch on if DC power is connected.
3. Turn the BATTERY BACKUP breaker switch on.

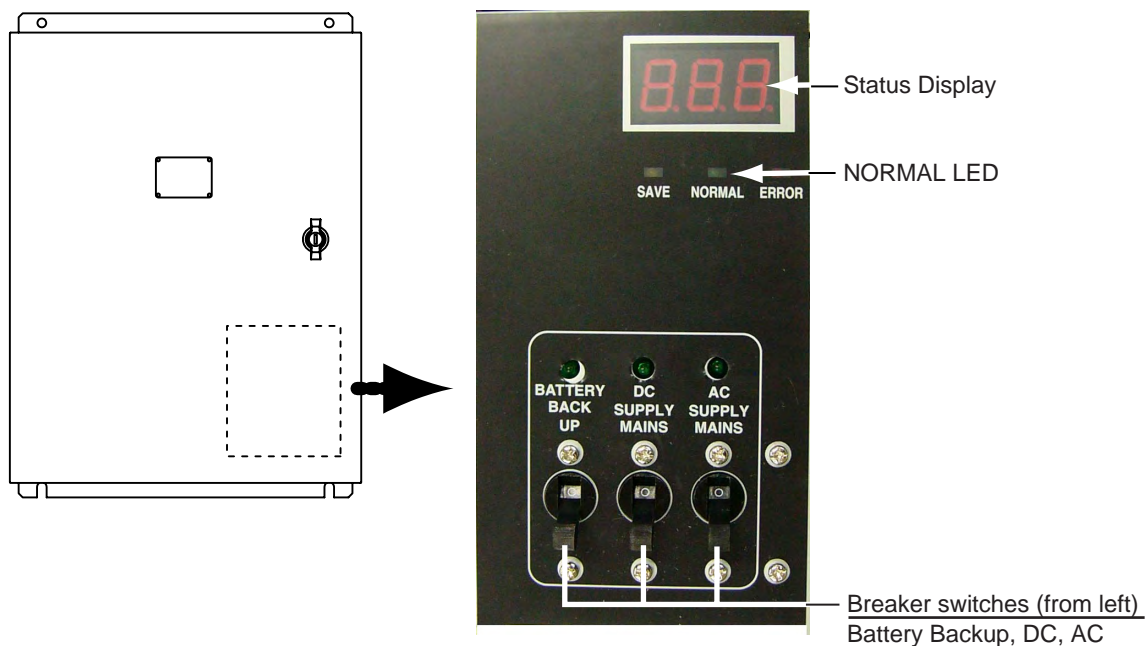

Power control panel/status display inside the DCU

Error indication on Remote Alarm Panel (RAP)

If the ERROR LED (red) lights on the RAP, check the error number on its status display and refer to the error code tables in Chapter 3.

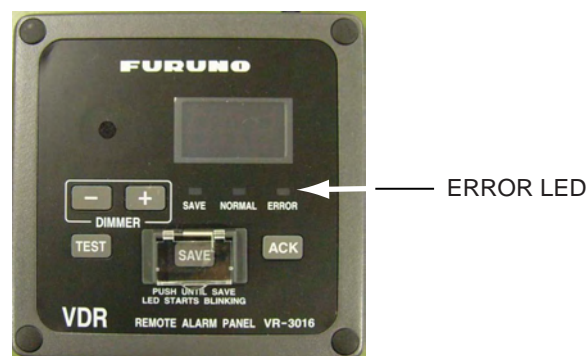

Remote Alarm Panel

IF AN INCIDENT OCCURS

Press the **SAVE** button on the Remote Alarm Panel. Bring the HDD with you after an incident occurs, if possible.

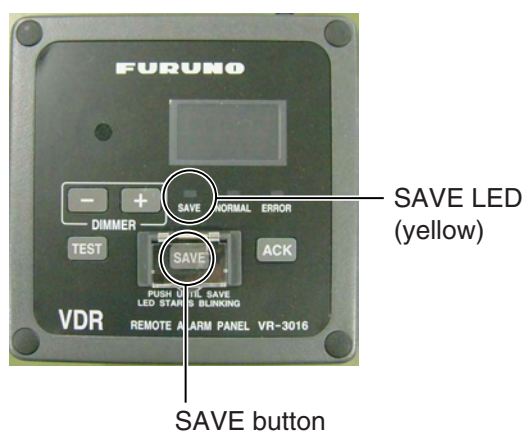

- The SAVE LED (yellow) starts flashing and shortly thereafter lights. Then, recording to the current memory area in the backup HDD in the Data Collecting Unit is stopped and recording to another memory area starts. The memory in the backup HDD is divided into four areas. If you press the **SAVE** button on the RAP, one recording area stops recording. If you press the **SAVE** button four times, all four areas stop recording. If you pressed the **SAVE** button, consult a FURUNO dealer to restore the HDD after an investigation of the incident is completed by the authorities.
- Recording at the Data Recording Unit continues.

TABLE OF CONTENTS

FOREWORD	vi
SYSTEM CONFIGURATION.....	vii
Record of PUB REV., PROG. No.	viii
1. OPERATION	1
1.1 Overview	1
1.2 Operating Procedure.....	6
1.2.1 Powering, recording.....	6
1.2.2 Stopping recording.....	6
1.3 Operation on Remote Alarm Panel	7
1.4 Removing HDD at an Incident.....	8
1.5 How to Release DRU	8
2. MAINTENANCE.....	9
2.1 Annual Recertification	9
2.2 Cleaning.....	9
2.3 Software Maintenance	10
2.3.1 Software list	10
2.3.2 Checking software version of system program	10
2.3.3 Checking software version of RAP	10
2.4 Replacing Batteries	11
2.5 Replacing Acoustic Beacon.....	12
2.6 Replacing Backup HDD	13
2.7 Replacing Fuses	14
2.8 Replacing Parts.....	14
2.9 Verifying Recording Function of the DRU	15
2.10 Confirmation of Peripheral Devices	16
3. TROUBLESHOOTING.....	17
3.1 General Troubleshooting.....	17
3.2 Error Codes.....	18
3.3 Testing Display of Remote Alarm Panel	20
4. LOCATION OF PARTS.....	21
4.1 Parts Location	21
4.1.1 Data Collecting Unit (VR-3010)	21
4.1.2 Data Recording Unit (VR-5020-9G or VR-5020-6G).....	22
4.1.3 Junction Box (IF-8530).....	23
4.1.4 Remote Alarm Panel (VR-3016).....	23
4.2 Parts List	24
5. INTERFACE (IEC 61162-1, IEC 61162-2).....	25
5.1 Data Sentences.....	25
5.2 Interface Circuits	38
5.2.1 IEC 61162-1.....	38
5.2.2 IEC 61162-2.....	39
APPENDIX: PLAYING BACK RECORDED DATA	40
SPECIFICATIONS.....	SP-1

FOREWORD

A Word to the Owner of the VR-3000, VR-3000S

Thank you for purchasing the FURUNO Voyage Data Recorder (VDR) VR-3000, Simplified Voyage Data Recorder (S-VDR) VR-3000S. We are confident you will discover why FURUNO has become synonymous with quality and reliability.

What is a VDR, S-VDR?

A VDR records various data and events encountered aboard ship. The purpose of the VDR is to help investigators locate the causes of marine incidents. There is no principle difference between a VDR and an S-VDR. The difference is the amount of information required to be recorded. The VDR is required to record more data than the S-VDR. Note that this manual refers to either the VDR or S-VDR as VDR.

The revised SOLAS Chapter V requires the installation of VDRs on passenger ships of 150 GT and above on all voyages and other ships of 3000 GT and above on international voyages and for newly built ships on and after 1 July, 2002.

The basic VR-3000/VR-3000S consists of a Data Collecting Unit (DCU), a Data Recording Unit (DRU), a Remote Alarm Panel (RAP) and microphones to record bridge audio. The VR-3000 is also equipped with a Junction Box (JB), which is optional on the VR-3000S. The DCU contains the Data Processor Unit, interface modules and backup batteries. It collects data from sensors as required by the IMO and IEC standards. The DCU processes the incoming data and information in the order of occurrence while old data is overwritten with new data for storage in the DRU for a 12 h period. The batteries supply power to the DCU to record bridge audio for 2 h in case of a main ship's power failure.

The flash memory in the DRU stores the data coming from the DCU. All essential navigation and status data including bridge conversation, VHF communications, and radar images are recorded. The data can be retrieved by using playback software for investigation after an incident. The DRU components are embodied in the protective capsule. The capsule ensures survival and recovery of the recorded data after an incident. An acoustical pinger helps locate the DRU underwater.

Features

- Reliable and fast data exchange between DCU and DRU via a single IEEE1394 cable.
- Easy commissioning and maintenance by PC downloading/uploading.
- 12-hour recording of normal sensor loading in standard memory.
- UTC time tagged for system synchronization and easy data retrieval.
- Choice of flash memory capacity in the Data Recording Unit.
- Backup hard disk (HDD) for storage and retrieval of data.
- Meets IMO A.861 (20), IEC 61996 and other relevant standards.

SYSTEM CONFIGURATION

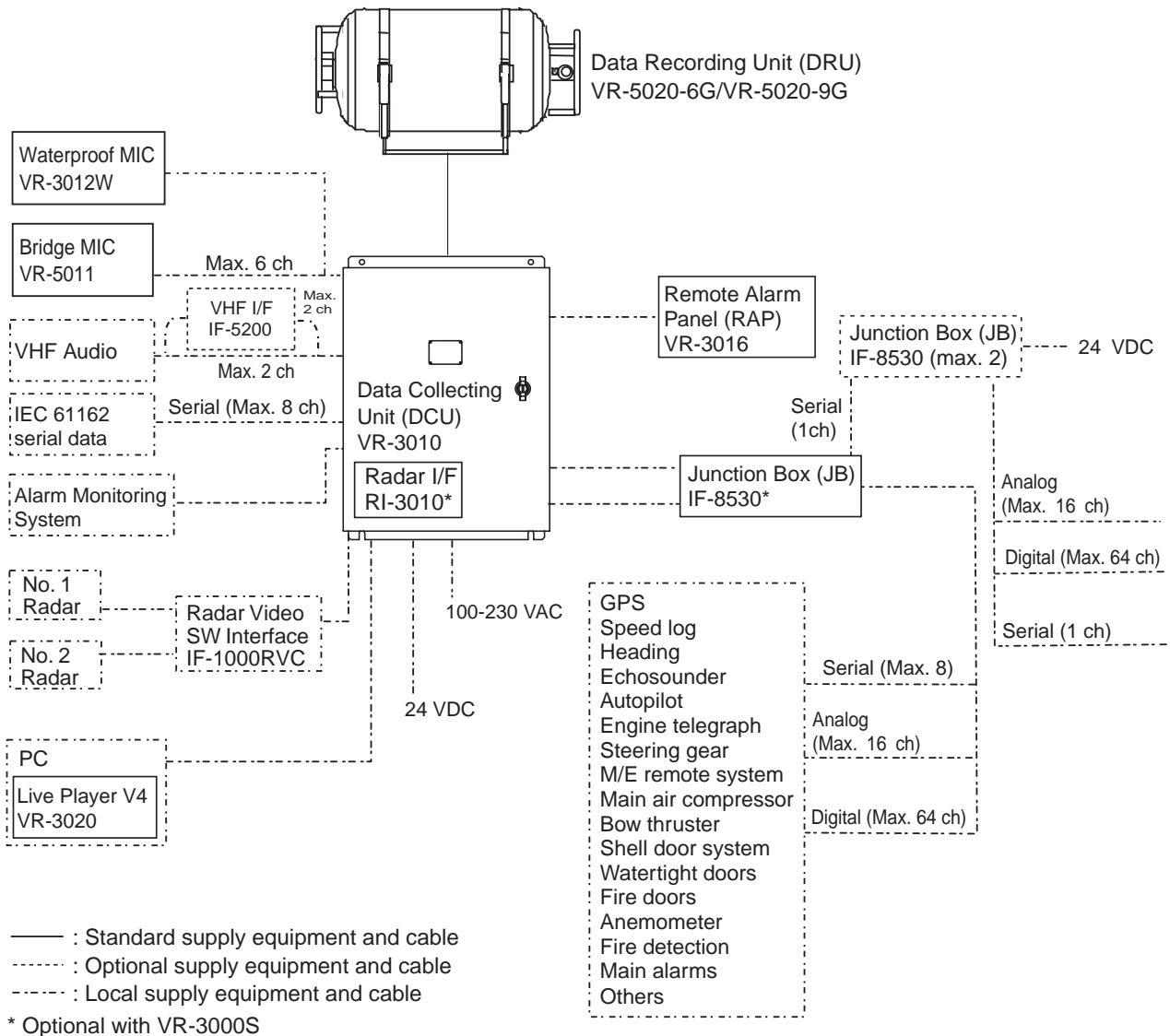

Environmental category

DCU	Protected from weather
DRU	Exposed to weather
RAP	Protected from weather
Bridge MIC	Protected from weather
Waterproof MIC	Exposed to weather
VHF I/F unit	Protected from weather
JB	Protected from weather
Radar Video SW Interface	Protected from weather

For the S-VDR, where it is impossible to obtain radar data, the AIS target data should be recorded as a source of information from other ships. (Ref. IMO Res.MSC.163(78), section 5.4.7.)

RECORD OF PUB REV., PROG. NO.

Revision No., Date of Revision	Program No. (software)	Outline of Revision
A Apr. 19, 2006	VR-3000 SYSTEM 2450031-01 RAP 2450026-01	1 st printing.
A1 June 2, 2006	Same as above	Revised system configuration drawings to include Waterproof MIC. Changed error code no. as follows: 035→034 Storage failure 041→042 Grabber failure 048→046 DRU Index error Revised specifications
B June 16, 2006	Same as above	All pages revised.
C July 24, 2006	Same as above	Added beacon cover.
D May 17, 2007	Same as above	Changed flush disk.
E July 9, 2008	VR-3000 SYSTEM 2450031-02 RAP Same as above	For new standard.
F Dec 15, 2008	Same as above	Miner program modification
G Jul. 20, 2010	Same as above	Miner program modification Revised the replacing parts. Added error codes; 173, 174, 431 and 432. Revised section 2.9.

1. OPERATION

1.1 Overview

The VR-3000/VR-3000S consists of Data Collecting Unit (DCU), Data Recording Unit (DRU), Remote Alarm Panel (RAP), Junction Box (JB, optional supply with VR-3000S) and bridge microphone units. The VDR system continuously stores data from the past 12 hours onto the Flash Memory in the capsule, erasing the oldest data stored as new data is recorded. The data to be recorded includes the following:

Parameters to be recorded	IEC 61162 formatter	Notes
Date and time	ZDA	
Ship's position and datum used	GNS and DTM	
Speed (water and/or ground)	VBW	
Heading (true)	HDT	
Heading (magnetic)	HDG	
AIS-VHF data-link message	VDM	
AIS-VHF data-link own-vessel message	VDO	
Depth (echo sounder)	DPT	
Alarms	ALR	No requirement for S-VDR to send alarm messages
Rudder order/response manual	RSA	
Rudder order/response automatic	HTC, HTD	
Engine order/response	RPM, XDR	
Hull openings, watertight doors	XDR	
Accelerations and hull stress	XDR, ALR	
Wind speed and direction	MWV	
VDR alarm output	\$VRALR	
Radar data		
Bridge audio		
VHF communication audio		

Power supply precaution

If ship's mains power source (100-230 VAC) and emergency source fail, the VR-3000/VR-3000S continues to record bridge audio for 2 h from backup batteries. When using the backup batteries, suspend power to the IF-8530 Junction box..

Continuity of storing data

The VDR should be provided with power to store data for 12 h on a first-in, first-out basis. Recording is terminated only under the following circumstances:

- a) During essential maintenance while the vessel is in port.
- b) When the vessel is laid-up.
- c) In case of emergency, when the backup HDD is removed.

Data Collecting Unit

The DCU mainly consists of Data Processor Unit and Power Control Panel. The DCU includes two 12 V backup batteries with a lifetime of approximately four years. The DCU collects the data from various sensors and radar and records them in the DRU and backup HDD.

Recording interval of data and audio is as follows:

- Radar video signal: every 15 seconds
- Bridge and VHF audio: real time
- IEC sentences: when received
- Analog and digital data: every second

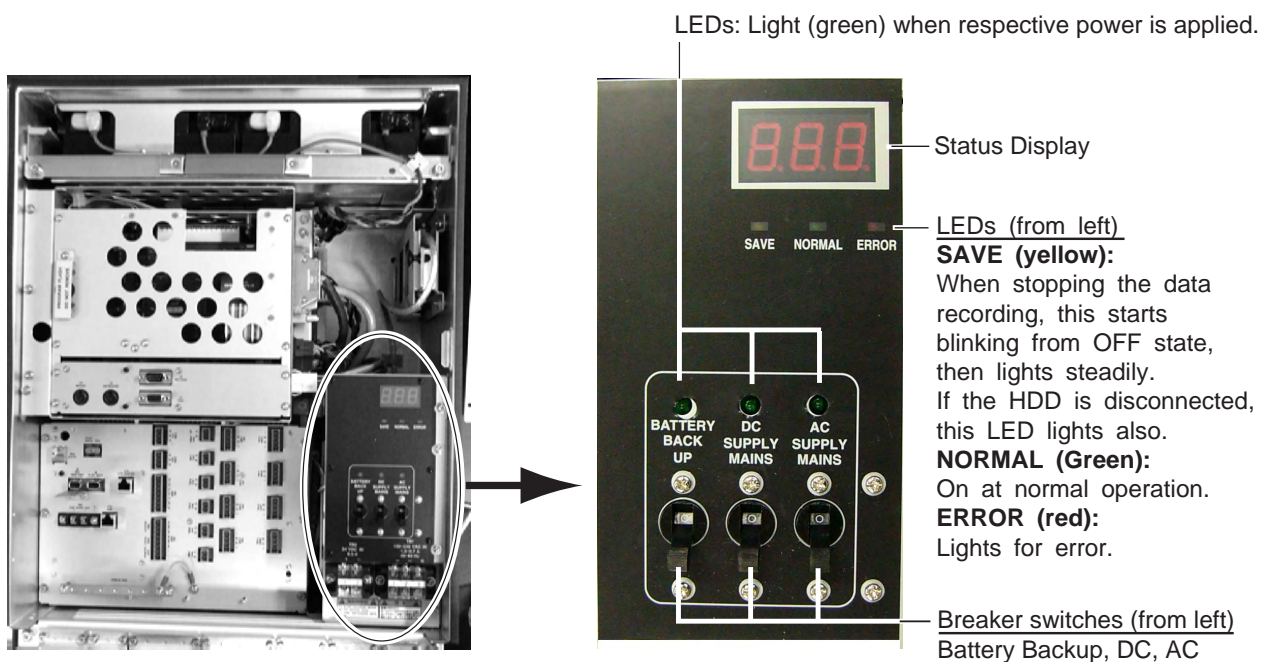

Data Recording Unit

The Data Recording Unit is housed in a highly visible protective capsule which can withstand a fire of 1100°C for 1 hour and deep-sea pressure of 6000 m.

The underwater acoustic beacon (pinger) on the capsule automatically transmits 10 ms pulses at 37.5 kHz for at least 30 days when it is submerged in water. The expected life of the beacon is 6 years. The DRU is connected to the Data Collecting Unit (DCU) with a non-halogen FireWire cable (IEEE1394).

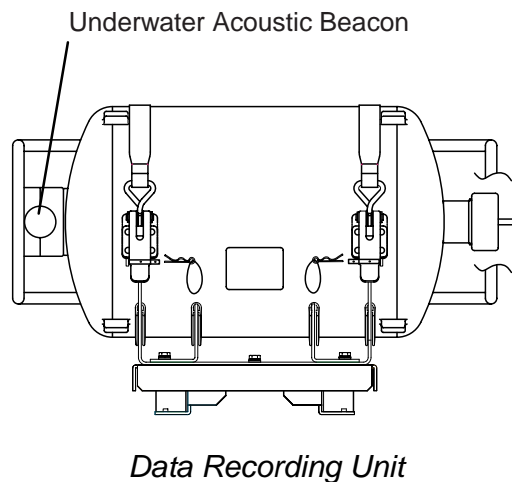

Integrity

The recording integrity is ensured by continuous monitoring of power supply, record function, bit error rate, and microphone functionality. Visual alarm is generated for malfunction of any of these. Alarm status is also indicated by relay contacts.

Data items to be recorded

Date and time

Date and time are obtained from an external GPS navigator referenced to UTC. Time information is recorded at intervals of 1 s. Without date and time data, no data except audio signal is recorded.

Ship's position and datum used

Latitude, longitude and datum are obtained from a GPS navigator, Loran-C receiver or other EPFS or INS available on standard digital interface. The source of data is identifiable on playback.

Speed (water and/or ground)

Speed through the water (STW) or speed over the ground (SOG) is recorded at intervals of 1 s. The resolution is 0.1 kt. Transverse speed is also indicated when available on board.

Heading (true, magnetic)

Heading is recorded at intervals of 1 s to a resolution of 0.1°. The data is labeled G (gyrocompass), GPS, GLONASS, MAG. If heading information is not available in IEC 61162 format, an appropriate interface may be necessary.

AIS-VHF data-link message, AIS-VHF data-link own-vessel message

Where there is no commercial off-the-shelf interface available to obtain radar data then AIS target data shall be recorded as a source of information regarding other ships, otherwise AIS information may be recorded additionally as a beneficial secondary source of information on both other and own ship.

The VDM message (UAIS VHF Data-link) shall be recorded in such a way that all target data available from the onboard AIS are acquired. If the VDO message (UAIS VHF Data-link Own-vessel report) is recorded, this shall be additional to the recording of individual sensor data.

Depth (echo sounder)

Depth under keel up to a resolution of 0.1 m as available on the ship is recorded.

Alarms

The status of all IMO mandatory alarms is recorded individually with ID number and time stamp. Audible alarms from the alarm units are stored simultaneously by the bridge audio microphones.

Rudder order/response

Rudder order and response angles are recorded up to a resolution of 1° as available on the ship. The rudder information is recorded. If more than one rudder is provided, the circuitry can be duplicated.

Engine order/response

The DCU obtains the engine order and response from the engine telegraph or direct engine control. The signal level is normally 0-10 V. The engine parameters with shaft revolution and ahead/astern indicators are recorded to a resolution of 1 rpm.

All order and response from bow, stern, thruster, tunnel thrusters and controllable pitch propellers shall be recorded. The S-VDR shall record this data if said serial data is available.

Hull openings, watertight doors

Inputs digital or RS-422 serial can be connected individually. The data is received at intervals of 1 s and stored with time stamps. Serial data sentence XDR is received at a data rate of 1,200-9,600 baud.

Accelerations and hull stresses

The DCU obtains signals from appropriate hull stress and response monitoring devices. The inputs are recorded individually and stored with time stamps. Serial data sentence XDR is received at a data rate of 1,200-9,600 baud.

Wind speed and direction

The DCU obtains the signal from appropriate wind speed and direction sensor. The inputs are recorded individually and stored with time stamps. Serial data sentence XDR is received at a data rate of 1,200-9,600 baud.

VDR alarm output

There is no requirement for the S-VDR to send alarm messages. If, as an option, such messages are sent then the appropriate sentence format is ALR.

Radar data

Radar image including range rings, EBLs, VRMs, plotting symbols, radar maps, parts of SENC, voyage plan, and other essential navigational indications, is recorded in the DRU via the interface in the DCU which is connected to the buffered video output of the radar display unit. One complete picture frame is captured at intervals of 15 s.

The radar display complying with IEC 60936-1 should have a buffered output (VESA DMTS compatible) with resolutions between 640 x 480 and 1280 x 1024, and can be directly connected with the VDR. Scanning may be interlaced or non-interlaced.

Bridge audio

Up to six microphones are supplied as standard to record conversation at conning station, radar display and chart table. If possible, the microphones should be positioned to capture the audio from the intercom, public address system, and audible alarms on the bridge. The microphones are labeled Mic1, Mic2, etc. Microphone captures conversation in the bridge, audio signals from equipment and sound from machinery. The microphone generates a test beep every 12 hours which is also recorded. The microphone picks up audio signals ranging from 150 to 6000 Hz.

Communications audio

A maximum of two VHF communications are recorded for both transmitted and received audio signals. The VHF radio connections are labeled VHF1 and VHF2.

1.2 Operating Procedure

The VDR comes with a key to lock the DCU to protect against any unauthorized access. The key must be kept securely after installation.

1.2.1 Powering, recording

On the power control panel in the DCU, turn on the AC SUPPLY MAINS, DC SUPPLY MAINS and BATTERY BACK-UP switches in this order. Confirm that the NORMAL LED on the power control panel and RAP lights. The VDR records data automatically in the DRU and backup HDD.

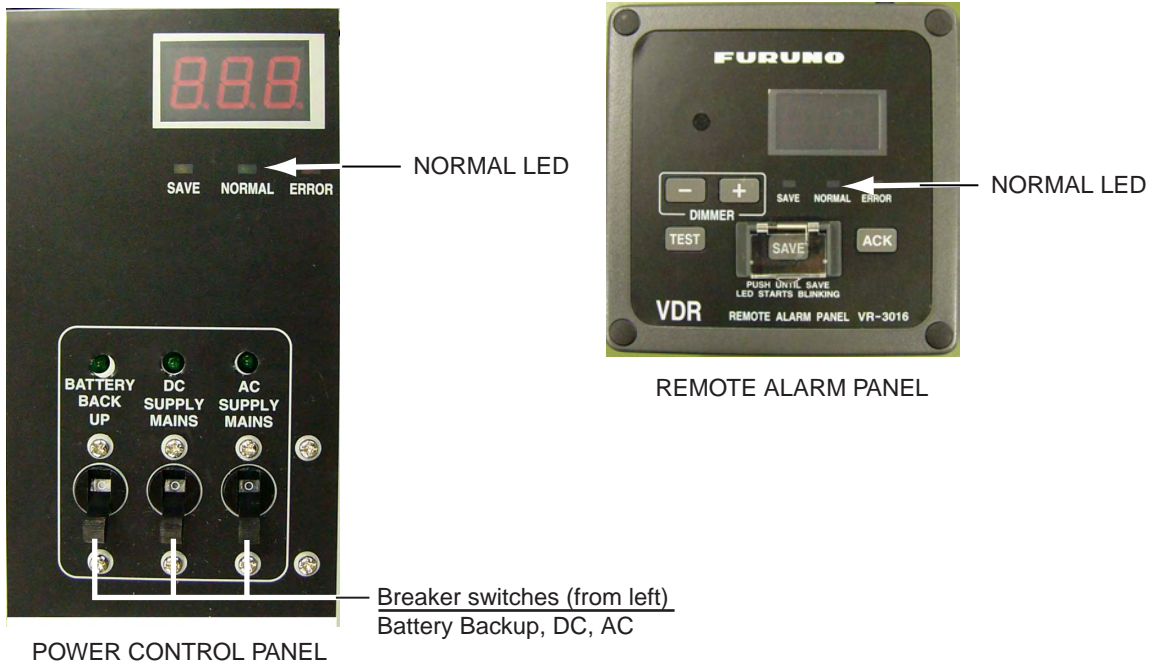

1.2.2 Stopping recording

Recording is terminated only under the following conditions:

- During essential maintenance purposes while the vessel is in port.
- When the vessel is laid-up.

To stop recording, turn off the BATTERY BACKUP, DC SUPPLY MAINS and AC SUPPLY MAINS switches in this order. **DO NOT turn off the system by the main breaker** while the BATTERY BACKUP switch is on. If this is done, the system operates on the batteries. The system stops after running on batteries after 2 hours.

1.3 Operation on Remote Alarm Panel

No power switch is provided on the Remote Alarm Panel; it is turned on and off by the power switch on the DCU. When the ERROR LED (red) on the Remote Alarm Panel is on, identify the error by checking code number in the error code tables in Chapter 3. The buttons on the Remote Alarm Panel work as described in the figure below.

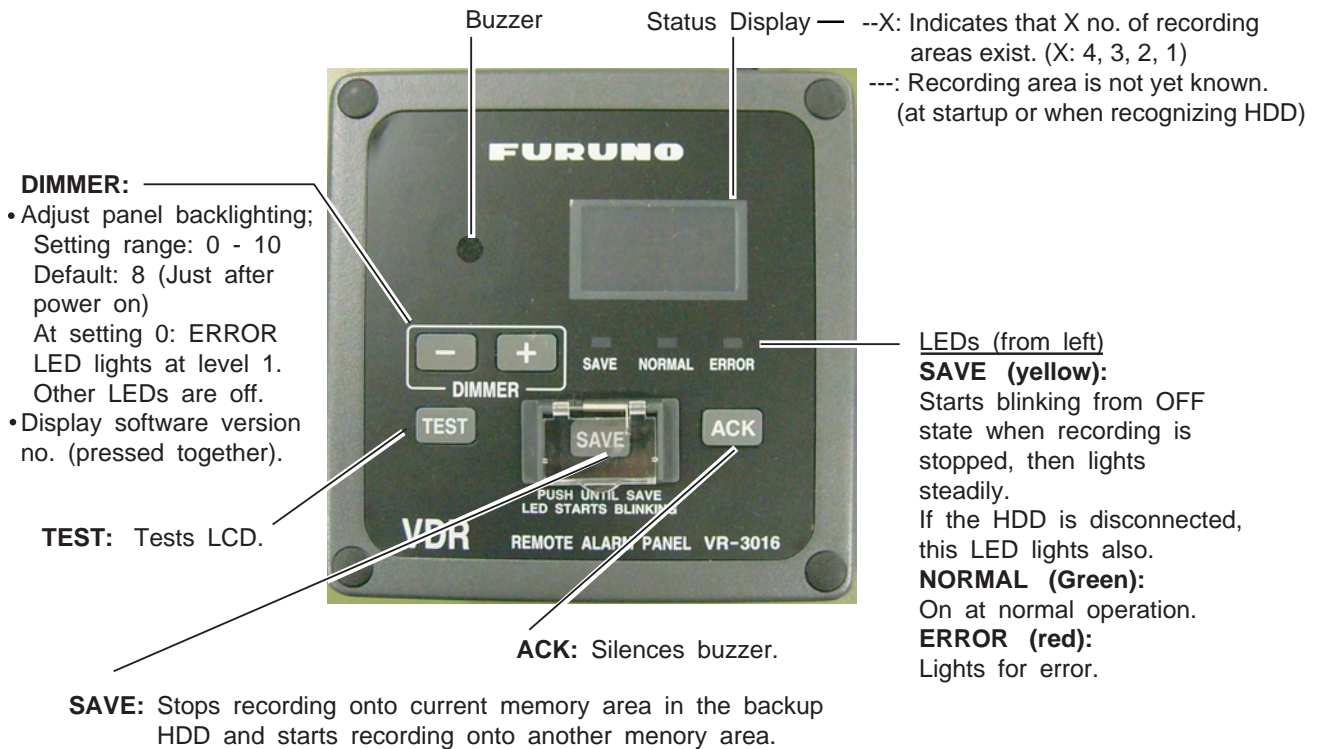

Note: The buzzer sounds every time the radar connected to the VDR is turned off. Press the **ACK** button to silence the alarm.

NOTICE

After pressing the **SAVE** button four times, data will not be recorded. Replace the HDD with an initialized one, or contact a FURUNO agent for necessary procedure.

SAVE button

If you press the **SAVE** button, the current memory area in the backup HDD stops recording and another area starts recording. If an incident occurs, press this button immediately. If another incident occurs, press the button again. The memory in the backup HDD is divided into four areas. When you press the **SAVE** button, the number of recording area in the HDD is reduced by one. After saving is completed, the buzzer sounds intermittently for 10 seconds. However, if an alarm is violated during the saving, the alarm buzzer has priority. If you press the **SAVE** button four times, all four areas stop recording. To remove the HDD, see paragraph 1.4.

If you pressed the **SAVE** button during an incident, consult a FURUNO dealer to restore the HDD after the authorities complete an investigation of the incident.

1.4 Removing HDD at an Incident

VDR information is copied automatically into the backup hard disk drive (HDD) for more than 12 hours (max. 13 hours) and is then automatically written over with new data. Bring the HDD with you after an incident if possible. *Press the **SAVE** button only when an incident occurs. To replace the HDD under other circumstances, see section 2.6.*

To remove the HDD, do the following:

1. Press the **SAVE** button (long press) on the RAP (Remote Alarm Panel). The yellow LED starts blinking, showing that recording is being terminated.
2. Wait until the LED lights steadily. If the LED does not light, press the SAVE button consecutively until the LED lights.

Note: Turning off the power is not required at an incident. However, to replace the HDD, turn off the power after the step 2.

3. Pull the knob on the HDD holder to open the holder.
4. Disconnect the IEEE1394 cable.
5. Remove the HDD.

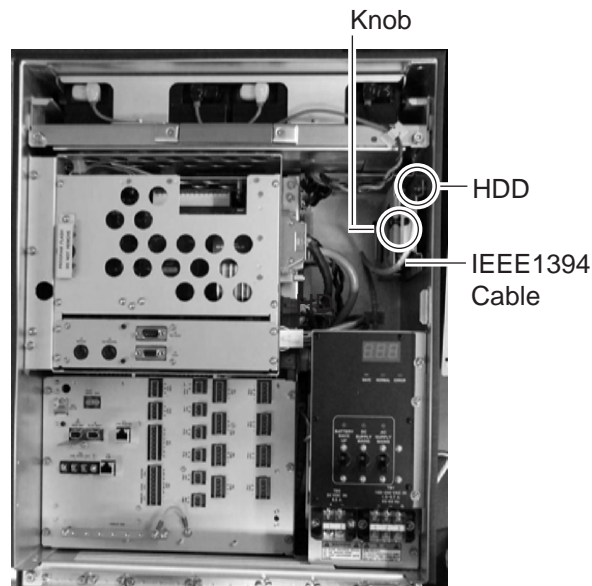

DCU, showing location of HDD

1.5 How to Release DRU

To remove the DRU from the bracket (cradle) do the following:

1. Loosen the hand-tightened cap.
2. Pull the DRU cable straight out.
(The cable may be cut after an incident.)
3. Remove two snap pins and then two hinge pins.
4. Lift the release levers.

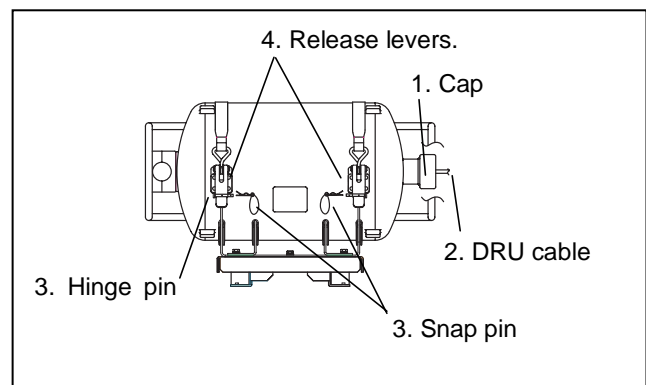

2. MAINTENANCE

Periodic checks and maintenance are important for proper operation of any electronic systems. This chapter contains maintenance instructions to be followed to obtain optimum performance and the longest possible life of the equipment. Any maintenance must be executed by a suitably qualified technician.

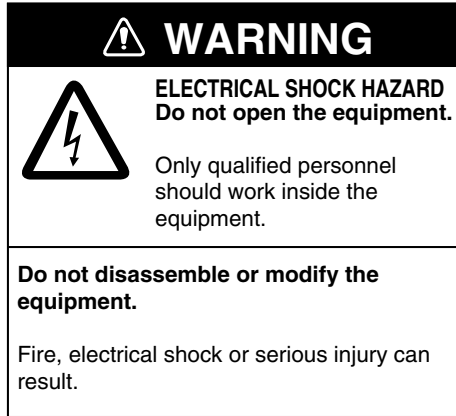

2.1 Annual Recertification

The VDR must undergo an annual performance test to recertify suitability. This test is conducted by a test engineer authorized by the manufacturer and certified by a relevant ship classification society, the content and procedure of the test in accordance with the regulations of that society. For further details about the VDR performance test, contact your ship classification society.

2.2 Cleaning

Dirt or dust may be removed from units with a soft cloth. Fresh water-moistened cloth may be used to remove stubborn dirt. DO NOT use any commercial cleaning agents to clean any unit. They can remove paint and markings. This is especially important with the Waterproof Microphone VR-3012W. The watertight integrity of the microphone will be compromised if any commercial cleaning agent contacts the ventilation sheet behind the MIC cover.

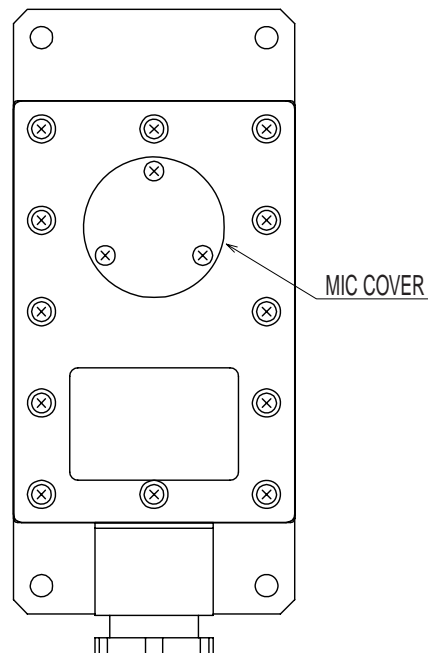

Waterproof microphone VR-3012W (bulkhead type)

2.3 Software Maintenance

2.3.1 Software list

The software and software version of the VR-3000/VR-3000S are as shown in the table below.

VR-3000/VR-3000S software list

Software name	Software version	Date
VR-3000 System Program	2450031-02	July 2008
VR-3000 RAP	2450026-01	Mar 2006

2.3.2 Checking software version of system program

Follow the procedure below to check software version of system program.

1. Start up a PC that uses Windows XP or Windows 2000 OS.
2. Change the IP address to 10.0.0.102 and the subnet address to 255.0.0.0.
3. Connect the cross LAN cable (supplied) between the LAN port on the PC and J14 (Data) in the DCU of the VR-3000/VR-3000S.
4. Start up the VDR Maintenance Viewer from the PC.
5. Open the menu of this program from Maintenance/VDR Config Management. The VDR Config Management screen appears.
6. Click the Download button on the screen.
7. Click the software tab to change the screen. The program version is displayed at the right side of the VDR system program.

2.3.3 Checking software version of RAP

Push and hold down the RAP's plus and minus buttons together. A three-digit number appears (for example, "101") and these digits are the version number.

2.4 Replacing Batteries

Every four years, the back-up batteries (2 pcs.) in the DCU must be replaced with new ones (Type: OP24-12 Code no.: 004-385-010) by a qualified service engineer. Note that the batteries should be recycled. Contact a FURUNO dealer for further details.

Observe the following precautions with the batteries:

⚠ WARNING

Battery handling precautions

- Do not attempt to dismantle the battery. If accidental skin/eye contact is made with the battery fluid, wash the affected area/part immediately with liberal amounts of clean fresh water and seek IMMEDIATE medical attention.

- DO NOT INCINERATE batteries as they are liable to rupture if placed into a fire. Batteries that have reached the end of their service life must be disposed of in accordance with appropriate regulations.

- Do not short battery terminals. Short can lead to bursting or fire.

⚠ CAUTION

Do not:

- use batteries of different capacities
- mix old batteries with new
- mix batteries of different makes

Batteries themselves may become damaged or damage to electrical parts may result.

To replace the batteries, do the following:

1. Open the DCU door with its key.
2. Power off the DCU.
3. Unfasten J3 connector from the PDU Board (24P0083)
4. Unfasten two screws securing the batteries.
5. Disconnect four battery leads, which are covered with the "vinyl boots".
6. Use the handle to remove batteries from the DCU.
7. Replace batteries.
8. Lock the DCU.

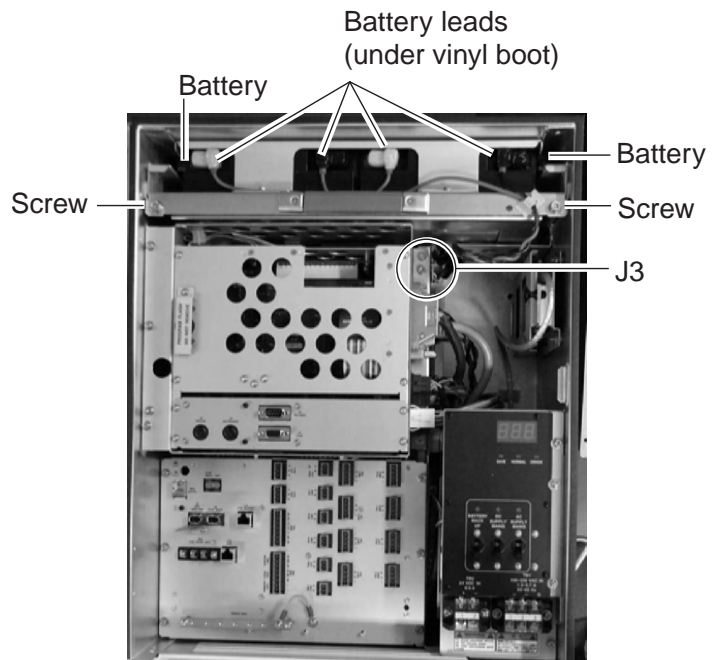

DCU, inside view

2.5 Replacing Acoustic Beacon

The life of the underwater acoustic beacon is approximately 6 years. It must be replaced (Type: DK-120, Code no. 000-148-648) by a qualified service technician before validity date marked on the beacon.

1. Unfasten two bolts and remove the beacon cover.
2. Use box screwdriver (7 mm) or slotted screwdriver to unfasten four bolts and then remove the beacon.
3. Attach a new beacon.

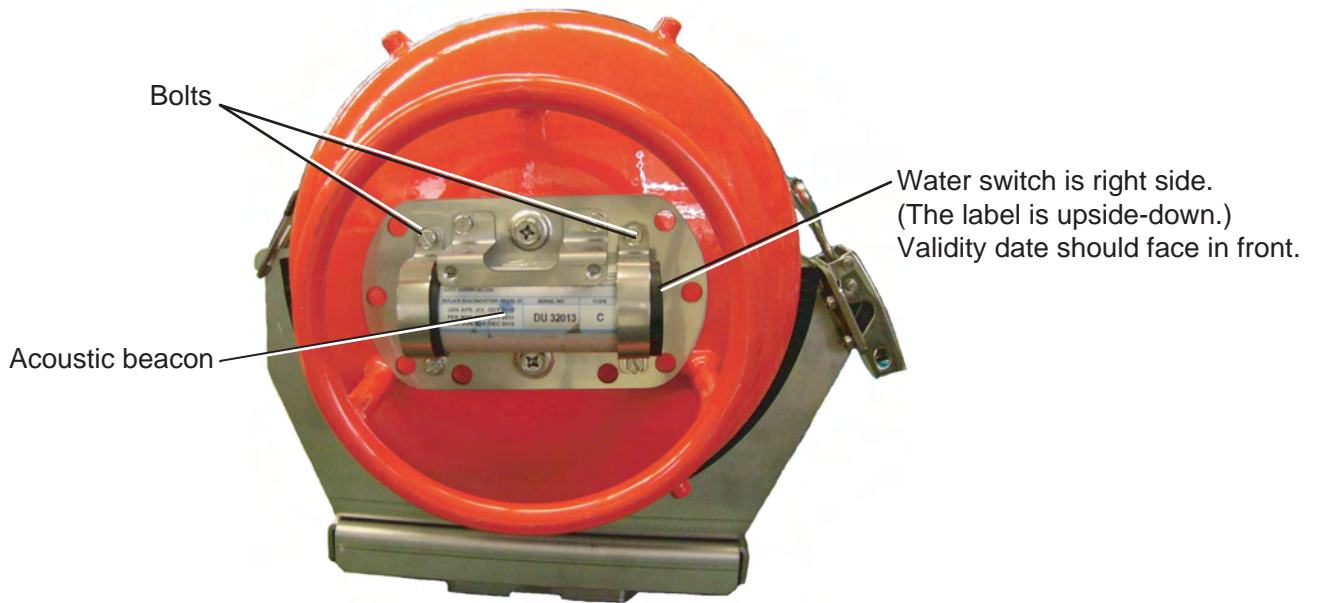

DRU (Beacon cover removed)

NOTICE: As the acoustic beacon contains a battery, it must be disposed of in accordance with appropriate regulations.

2.6 Replacing Backup HDD

On some vessels several backup HDDs (Type: VR-3011, Code No.:004-385-000, Option) are carried onboard, replacing one when it is necessary to transport it from the vessel for playback and extract.

A backup HDD may only be replaced in the follow situations:

- 1) When the equipment can be powered off; for example, maintenance while in port, etc.
- 2) An incident has occurred and the Save button on the RAP (VR-3016) was operated to stop recording.

An HDD may not be re-used for recording after the Save button has been operated four times. Contact a FURUNO dealer for further details.

A backup HDD records navigation data for more than past 12 hours (13 hours max). For longer recording, use Live Player Backup.

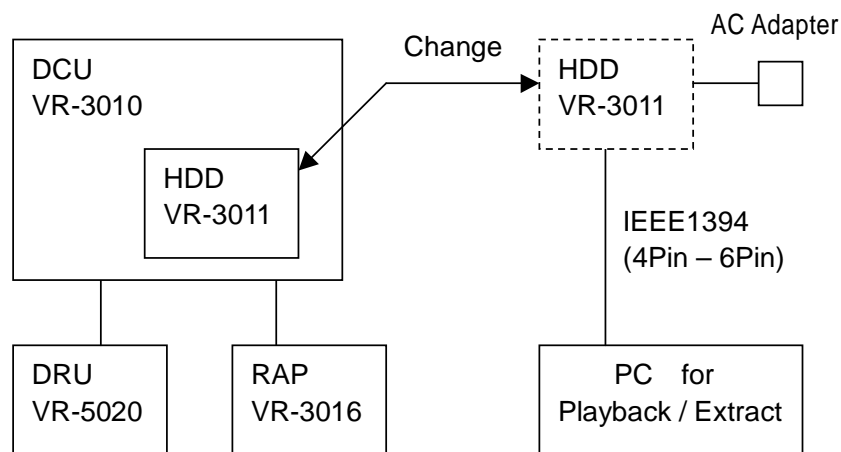

Replacing backup HDD

1. Open the DCU with its key. Turn off the DCU.
2. Pull the knob on the HDD holder to open the holder.
3. Disconnect IEEE1394 cable from the HDD. Remove the HDD.
4. Set new HDD to holder.
5. Connect IEEE1394 cable.
6. Push knob on the HDD holder to close the holder. Turn on the DCU.
7. Confirm that HDD is operating (DCU power is ON, Save LED is OFF) with no error.
8. Close the DCU and lock it with its key.
9. Refer to the operator's manual of the Live Player Pro for how to playback/extract recorded data from the Backup HDD.

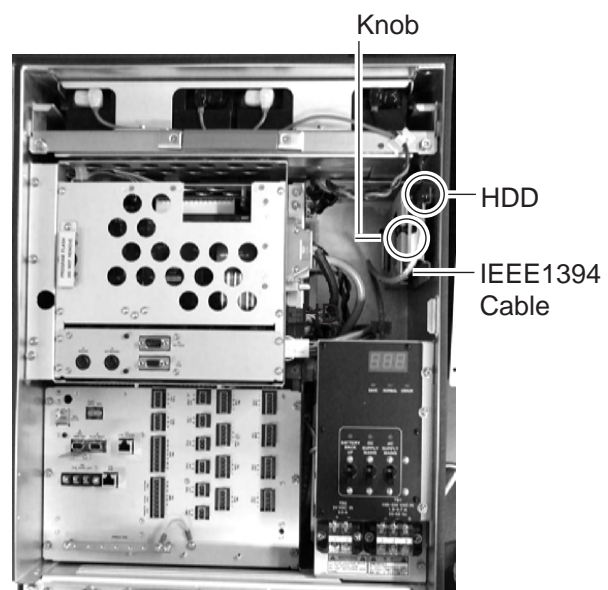

2.7 Replacing Fuses

The battery cable in the DCU contains two 10A fuses in fuse holders. If a fuse blows, the BACKUP BATTERY LED may not be lighting. Find the cause before replacing a fuse. Have a serviceman replace any fuse.

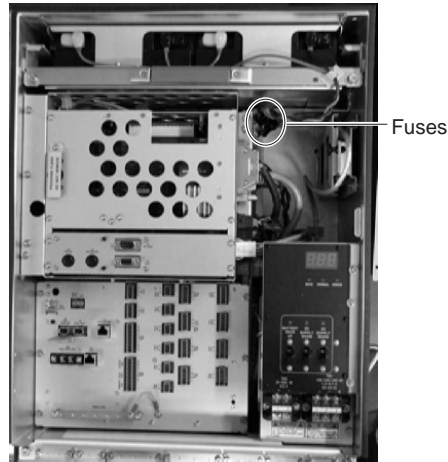

2.8 Replacing Parts

Interval-specific parts

The batteries in DCU and the acoustic beacon on the DRU must be replaced every 4 and 6 years respectively to comply with IMO conventions. Record the date of expiration on the card in the card holder on the door of the DCU.

Part	Replacement interval	Remarks
Battery in DCU	4 years	2 pcs., replace together
Acoustic underwater beacon in DRU	6 years	

Consumable parts

The parts in the table below should be replaced before the estimated lifetime shown. The period of expiration begins from the date of installation. Record the date of replacement on the card in the card holder on the door of the DCU.

Consumable part	Life	Remarks
Backup HDD	2 years / 25°C	Data cannot be recorded to the backup HDD when it fails. Error 018 is generated when this occurs.
DC-DC converter	4 years / 25°C*	If DC power supply fails, RAP indicates 082 and AP in DCU indicates 84.
DCU chassis fan	6 years / 25°C*	Failure of one or both of these fans prevents the CPU from operating, which may prevent start up of the VDR.
DCU CPU fan	6 years / 25°C*	
CMOS battery on CPU board in DCU	6 years / 25°C	Failure of this battery prevents GPS time synchronization. Error 026 is generated when this occurs.
AC power supply	6 years / 25°C	If AC power supply fails, RAP indicates 214 with AC power switch ON.

* = Product has a 90% probability of achieving full lifespan

2.9 Verifying Recording Function of the DRU

Verify the DRU's recording function at the annual inspection and when repairing or maintaining the VDR or sensors connected to the VDR. The verification requires the Live Player V4. Refer to its Operator's Manual for the operating procedure. Note that data cannot be extracted during recording.

- 1 Set the Playback/CPU switch in the DCU to the Playback position.
2. Wait about 10 minutes and verify that Alarm 174 occurs.
- 3 Connect the PC to DCU as shown in the Figure below.

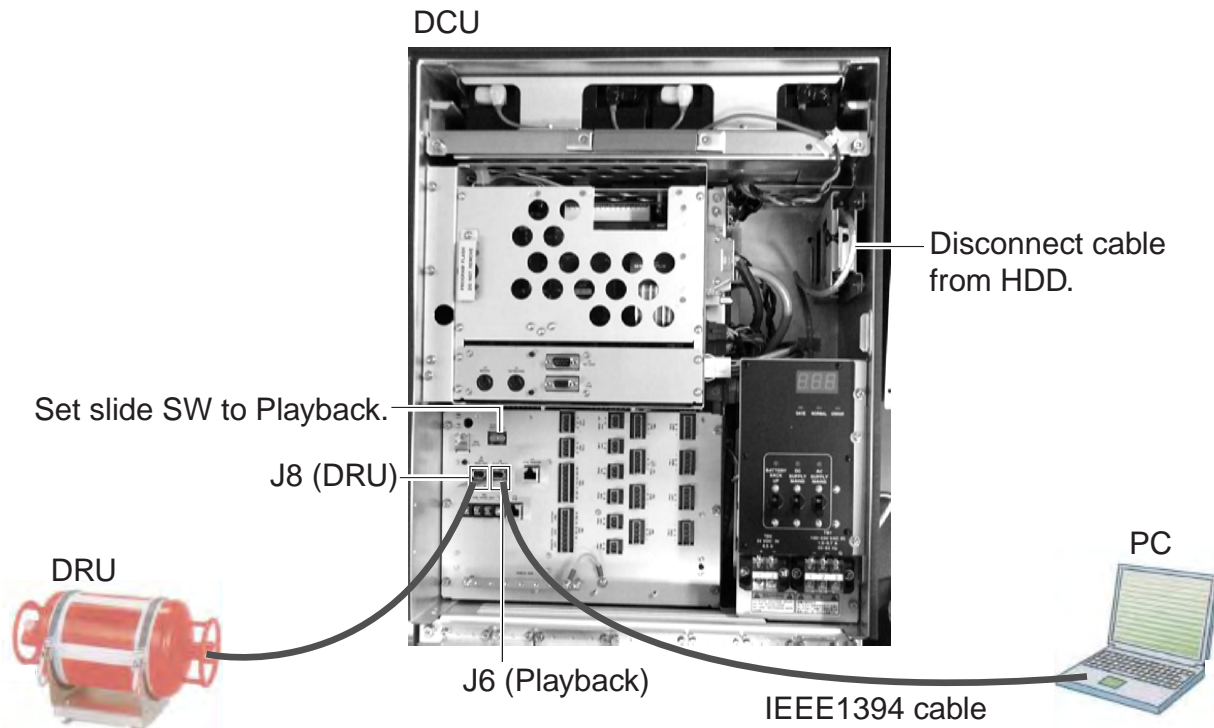

- 4 Disconnect the cable attached to the Backup HDD.
5. Start the **Live Player V4** on the PC.
- 6 Open the **Tool** menu and select **Source Select**. Select **DRU** from the pull-down menu.
- 7 Click the **Analyze Track** button.
- 8 Click the **Connect** button.
9. Select **Extract** from the Tool menu to show the Extraction dialog box.
10. Select the track to extract.
11. Click the **Select** button and select the location where to save data.
12. Click the **Start** button.
13. After the extraction is completed, click **OK**, **Close** and **Close** in that order. Then, do the following.
 - a) Disconnect the cable between the PC and J6 on the DCU.
 - b) Connect the Backup HDD.
 - c) Set the Playback/CPU slide switch in the DCU to the CPU position.

2.10 Confirmation of Peripheral Devices

Confirm the data from serial signal output devices, analog signal output devices and contact signal output devices. To do this, connect the PC to the DCU and use the Live Player software.

Serial signal output devices

The threshold levels of the time-out for serial signal input are preset. If the data is not input to the VDR, an error code appears on the Remote Alarm Panel (see paragraph 3.2). Confirm the accuracy of the input signal, comparing the value of the input sensor and preset value in the VDR.

Analog and contact signal output devices

Confirm the signal value and accuracy, comparing the indication of the input device and the input value on the VDR.

3. TROUBLESHOOTING

This chapter provides information on possible causes of problems you may experience with your VDR. If you still have a problem after referring to the table, contact your local dealer or national distributor for further advice. Always provide the product serial number.

3.1 General Troubleshooting

Use the table below to identify the trouble, cause and possible solution.

Troubleshooting table

Symptom	Possible causes	Possible solution
AC and/or DC LED not lit	No power supply	Check the breaker switches on ship's mains switchboard.
BATTERY BACKUP LED not lit	No power from the battery	Call for service.
ERROR LED lighting in red	Malfunction of the system	Restart the system. If the problem still remains, call for service. Check integrity of DRU connection.

3.2 Error Codes

Error codes may appear on the status display on the Power Control Panel to alert to possible trouble. Below is a list of those codes.

System software: 2450031-02

Error	Error Name	Description	Action
--4 --3 --2 --1 ---		Normal operation. "--X" (X:1,2,3,4) means number of exting recording area in the HDD. "---" is shown at startup or when recognizing HDD.	
HDD	BACKUP_HDD_MISSING	Backup HDD not connected to VDR, or no memory area.	1) SAVE button pressed and backup HDD removed: Replace backup HDD 2) Other situations: Reset VDR. If normal operation not restored, request service.
018	Backup HDD No Connection	This indicates that the BACKUP has been disconnected more than 120 seconds.	Connect BACKUP HDD or investigate LOG and repair/replace.
022	DRU No Connection	DRU has been discontinued more than 120 seconds.	Connect DRU again or investigate LOG and repair or replace.
026	GPS Large Time Difference	This indicates that the time difference between system time and time supplied by UTC source is more than the specified time.	Restart VR-3000/S. Try to see if the CMOS clock is set correctly. If not, set it and restart VR-3000/S. If yes, find out why the time source device GPS is delivering "out of bands" time info.
042	Radar No Connection	One of the active/enabled video channels can't grab from the channel. This can be either because radar is turned OFF or wrong configuration.	If radar is turned OFF, press ACK on the RAP to silence alarm. Turn on radar. If no error appears, the system is normal. If the error appears, check cable connections or setting.
082	RAP No Connection	RAP is missing. Connection to RAP is lost.	Check cable connected to RAP. Reconnect RAP.
084	AP No Connection	No alarm panel connection	Check connection to alarm panel.
088	JB No Connection	Indicates that Junction Box (No.1) is missing.	Check cable and IP-address setting.
094	Backup HDD Recording Fail	Indicates that Backup is inactive-not storing data.	Check connection to Backup HDD. If not still storing, request service.
098	DRU Recording Fail	Indicates that DRU is inactive-not storing data.	Check connection to DRU. If not still restarting recording, request service.
170	VDR Configuration Fail	Data can not be stored because VDR setting data is corrupted.	Restore VDR settings data. If not, request service.
171	VDR Recording Buffer Overflow	Radar video inputs over the capacity of the recording buffer memory.	Check or reduce the radar channels or video resolution.
173	Fatal System Failure	Fatal system error. VR-3000/S rebooted automatically after an error occurred.	If VR-3000/S repeat continuously, request service
174	IEEE1394 Bus Recover Giveup	Cannot Recover DRU and Backup HDD.	Restart VDR. If VR-3000/S does not recover, request service

(Continued on next page)

Error codes (con't from previous page)

Error	Error Name	Description	Action
186	DRU Memory Shortage	It looks that data cannot be recorded more than 12 hours.	Modify radar recording setting. Max. recordable channel: two channels.
214	Battery Running	Both AC and DC power are down and switching to battery drive. Audible alarms are generated for max. two	Reconnect AC and/or DC power.
218	MIC Test Fail	This ALARM is issued when the microphone test fails. This test can be run from Audio tab in the VDR Maintenance Viewer, and is run every 12-hours during normal operation.	Check MIC TEST in the VDR Maintenance Viewer. If this is OK, locate the faulty microphone and check/replace it.
226	DRU Flash Device No match	This indicates that no. of FLASH devices found in DRU and defined in CONFIGURATION is not same.	Check if no. of FLASH devices and configuration setting are same.
234	GPS No Connection	System does not receive UTC information.	Check that a valid UTC source is connected to the serial port defined as UTC source.
246	PDU No Connection	Cable connection inside DCU is faulty.	Check cable between PDU and CPU block in DCU.
254	Self Test Fail	System failed by the self test.	Request service.
3xx (301-372)	Serial No Connection	Data is not delivered from a serial channel within an assigned time.	Reconnect serial data. Check failed device.
401	Battery No Connection or Battery Voltage Low	Battery voltage is not coming or it is low.	Confirm that the battery switch is turned on. If ok, battery is required to replace a new one.
402	Terminal Board No Connection	Terminal board is abnormal.	Confirm cable connection between terminal board and audible interface board.
403	Battery Voltage Low	Batter voltage is lowered.	It is required replacement of battery.
406	DRU Exchanged	This indicates that DRU is replaced.	Restart VR-3000/S
407	Backup HDD Exchanged	This indicated that backup HDD is replaced.	Restart VR-3000/S
411	Frame Grabber Board Fail	Radar interface board is available but it is not recognized.	Request service.
412	Audio Board Fail	Audible interface board is available but it is not recognized.	Request service.
413	Serial Board Fail	Serial interface board is available but it is not recognized.	Request service.
42x (422-428)	JB No Connection	Poor connection between JB(No.2-8)and DCU.	Check cable and IP-address setting.
431	DCU Serial Buffer overflow	Serial data from DCU serial channels (1-8) aren't recorded to DRU and Backup HDD correctly.	Restart VDR. If error occurs again, request service.
432	JB Buffer overflow	Serial, analog and digital data from Junction Box aren't recorded to DRU and Backup HDD correctly.	Restart VDR. If error occurs again, request service.

3.3 Testing Display of Remote Alarm Panel

Press the **TEST** button on the RAP to check that all LCD segments are displayed properly.

4. LOCATION OF PARTS

4.1 Parts Location

4.1.1 Data Collecting Unit (VR-3010)

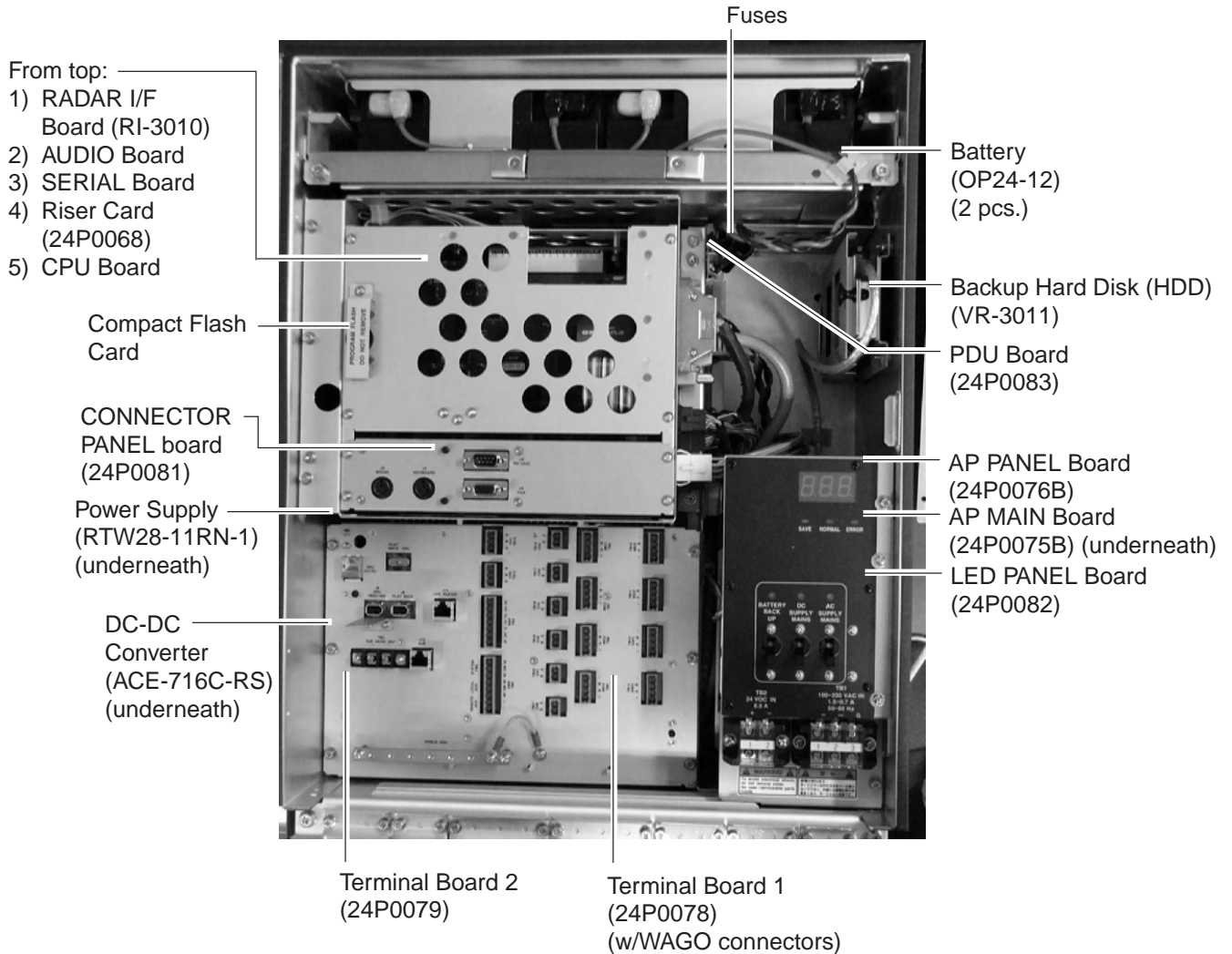

Data Collecting Unit (VR-3010)

4.1.2 Data Recording Unit (VR-5020-9G or VR-5020-6G)

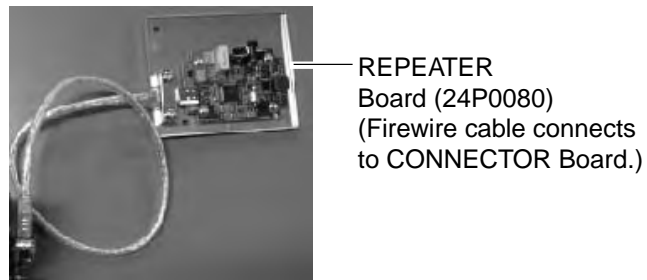
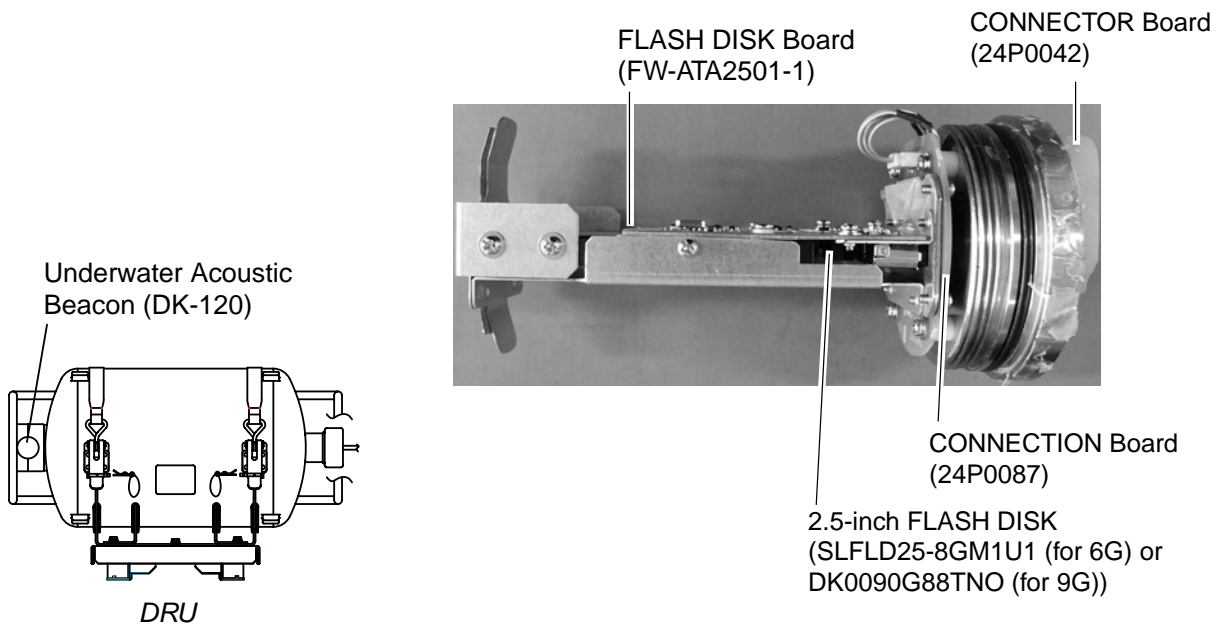

Components inside capsule

Data Recording Unit (VR-5020-9G or VR-5020-6G)

4.1.3 Junction Box (IF-8530)

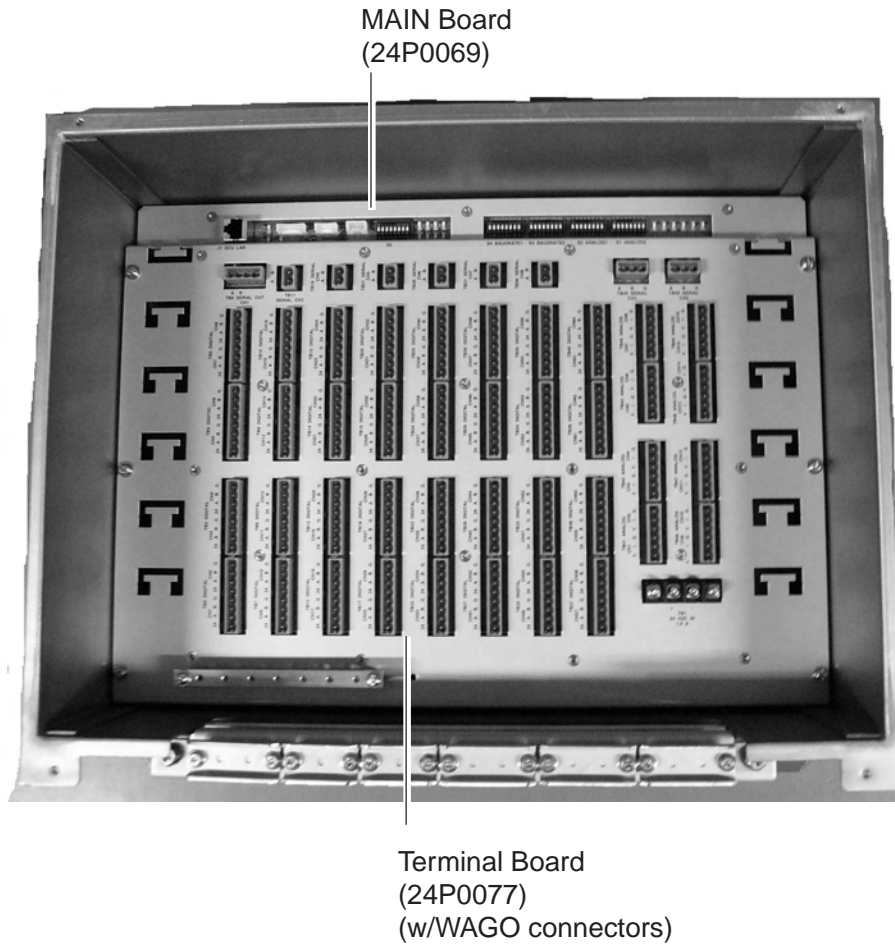

Junction Box (IF-8530)

4.1.4 Remote Alarm Panel (VR-3016)

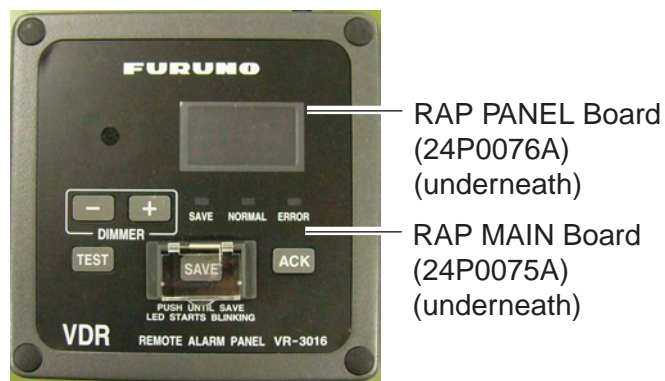

Remote Alarm Panel (VR-3016)

4.2 Parts List

This equipment contains complex modules in which fault diagnosis and repair down to component level are not practical (IMO A.694(17)/8.3.1. Only some discrete components are used. FURUNO Electric Co., Ltd. believes identifying these components is of no value for shipborne maintenance; therefore, they are not listed in this manual. Major modules can be located on the parts location on previous pages.

Name	Type	Code No.
Data Collecting Unit (VR-3010)		
AP MAIN Board	24P0075B	004-385-320
AP PANEL Board	24P0076B	004-385-330
AUDIO Board	PCI-9111-DG	000-148-411
Battery (2 sets)	OP24-12	004-385-010
Compact Flash Card	CFI-128MDG(H02AA)	004-385-140
CONNECTOR PANEL Board	24P0081	004-385-110
CPU Board	PEB3730VL2A	004-383-400
DC-DC Converter	ACE-716C-RS	004-385-450
RADAR I/F Board	RI-3010	004-388-070
LED PANEL Board	24P0082	004-385-340
PDU Board	24P0083	004-384-750
Power Supply	RTW28-11RN-1	004-385-390
Riser Card	24P0068	004-385-070
SERIAL Board	99033-8	000-156-911
Terminal Board 1	24P0078	004-385-350
Terminal Board 2	24P0079	004-385-700
Backup Hard Disk (HDD)	VR-3011	004-385-000
Data Recording Unit (VR-5020-9G or VR-5020-6G)		
CONNECTION Board	24P0087	000-166-816-10
CONNECTOR Board	24P0042	004-381-030
FLASH DISK	SLFLD25-8GM1U1 (for 6G)	000-166-792-10
	DK0090G88TNO (for 9G)	000-166-822-10
FLASH DISK Board	FW-ATA-2501-1	000-161-500-11
REPEATER Board	24P0080	000-155-924-01
Underwater Acoustic Beacon	DK-120	000-148-648
Junction Box (IF-8530)		
MAIN Board	24P0069	004-385-490
Terminal Board	24P0077	004-385-510
Remote Alarm Panel (VR-3016)		
RAP MAIN Board	24P0075A	004-385-520
RAP PANEL Board	24P0076A	004-385-560

5. INTERFACE

(IEC 61162-1, IEC 61162-2)

5.1 Data Sentences

Some sentences described here are the ones proposed by the recent IEC TC80/WG6 (Digital Interface Working Group) at the time of this publication. They are marked with PAS 101 or PAS 102.

ALA - Set detail alarm condition

0 1 2 3 4 5 6 7 8 9
\$xxALA, hhmmss.ss, aa, aa, xx, xxx, A, A, c—c *hh<CR><LF>

0: Header 1: Event time (Optional) 2: System indicator of alarm source
3: Sub-system/equipment/item indicator of alarm source 4: Number of equipment / units / items
5: Number of alarm source 6: Alarm condition 7: Alarm's acknowledge state
8: Alarm's description text 9: Check-sum

ALR - Set alarm status (PAS 101)

Updated the text label of the alarm identification field to be the same as that field in the ACK sentence.

\$--ALR, hhmmss.ss, xxx, A, A, c--c *hh<CR><LF>

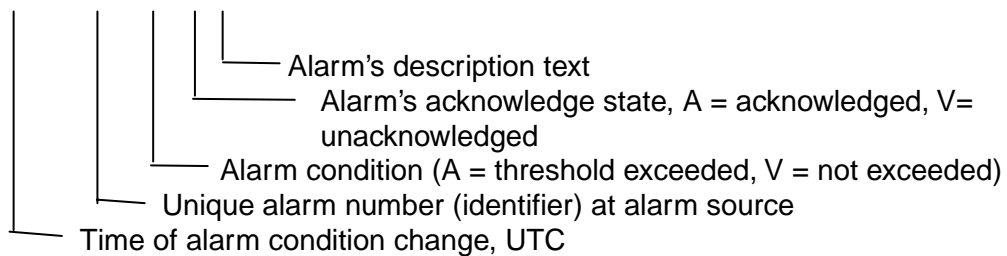

DOR - Door status indication

This sentence indicates the status of watertight doors, fire doors and other hull openings / doors. Malfunction alarms of the watertight door, fire door and hull opening/door controller should be included in the “ALA” sentence.

\$xxDOR, A, hhmmss.ss, aa, aa, xxx, xxx, A, c—c, *hh<cr><lf>

0 1 2 3 4 5 6 7 8 9

0) Header

1) Message type

S: Status for section: the number of faulty and/or open doors reported in the division specified in field 4. The section may be a whole section (one or both of the division indicators are empty) or a sub-section. (If S is used then it shall be transmitted at regular intervals.)

E: Status for single door. (E may be used to indicate an event).

F: Fault in system: If limited to one section, indicated by division indicator fields, if not, division indicators empty. (F may be used to indicate an event.)

2) Time stamp

Time when this status/message was valid.

3) System indicator of door status

Indicator characters as door system. The field is two fixed characters.

4) Division indicator of door allocation (1)

Indicator showing division where door is located. This field is two characters.

It may be physical fire zone or entity identifier for control and monitoring system, e.g., central number.

5) Division indicator of door allocation (2)

Indicator showing in which division the door is located. This field is three numeric characters.

It may be physical deck number or identifier for control and monitoring system sub-system, e.g., loop number.

6) Door number or door open count

Number showing door number or number of doors that are open/faulty.

This field is three fixed numeric characters.

7) Door status

This field includes a single character specified by the following: when S status indicated in 2nd field, this field is ignored

O = Open

C = Close

F = Free status (for watertight door)

X = Fault (impossible to know state)

8) Message's description text

Additional and optional descriptive text/door tag. Also if a door allocation identifier is string type, it is possible to use this field instead of above door allocation fields.

Maximum number of characters will be limited by maximum sentence length and length of other fields.

DPT - Depth

IMO Resolution A.224 (VII). Water depth relative to the transducer and offset of the measuring transducer. Positive offset numbers provide the distance from the transducer to the waterline. Negative offset numbers provide the distance from the transducer to the part of the keel of interest.

\$--DPT, x.x, x.x*hh<CR><LF>

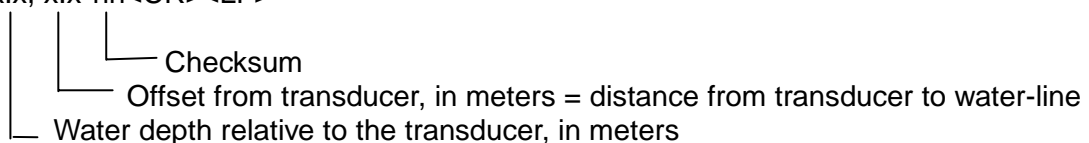

DTM - Datum reference (to be further developed)

Local geodetic datum to which a position location is referenced.

\$--DTM, ccc, a*hh<CR><LF>

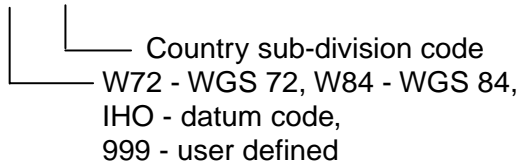

ETL - Engine telegraph operation status

The ETL sentence indicates engine telegraph position including operating location and sub-telegraph indicator.

\$xxETL, hhmmss.ss, a, xx, xx, a, x, *hh<cr><lf>

0 1 2 3 4 5 6 7

- 0) Header
- 1) Event Time
- 2) Indicator of command
O = Order
A = Answerback
- 3) Position indication of engine telegraph
00 = Stop engine
01 = [AH] Dead Slow
02 = [AH] Slow
03 = [AH] Half
04 = Full
05 = [AH] Nav. Full
11 = [AS] Dead Slow
12 = [AS] Slow
13 = [AS] Half
14 = [AS] Full
15 = [AS] Crash Astern
- 4) Position indication of sub telegraph
20 = S/B (Stand-by engine)
30 = F/A (Full away – Navigation full)
40 = F/E (Finish with engine)
- 5) Operating location indicator
B = Bridge
P = Port wing 1
S = Starboard wing 1
C = Engine control room
E = Engine side
- 6) Number of engine or propeller shaft
0 = single or on centre-line
Odd = starboard
Even = port
- 7) Checksum

FIR - Fire detection (PAS 102)

0 1 2 3 4 5 6 7 8 9 10
\$xxFIR, A, hhmmss.ss, aa, xx, xxx, xxx, A, A, c--c, *hh<CR><LF>

0: Header 1: message type 3: System indicator of fire detection 4: Division indicator of door allocation (1) 5: Division indicator of door allocation (2) 6: Fire detector number or activation detection number count 7: Condition 8: Alarm's acknowledge state 9: Alarm's description text 10: Check-sum

GEN - Generic status information

This sentence provides a means of transmitting multi-sensor generic status information from any source, in a format that can be registered by the VDR. The sentence is designed for efficient use of the bandwidth and must be accompanied with a description of how to interpret the information. Each sentence holds a base address for all status groups. Each group is assigned a 16-bit address. Up to eight contiguous groups with increasing address may be transmitted in a single sentence. Data is blocked in 16-bit groups. Unused bits shall be assigned a fixed value to simplify data compression.

A separate configuration with interpretation of bit equal to "1" and "0" for all sentence groups and bit positions that are used, must be provided as this information is not included in the sentence. It is the responsibility of the talker to provide this information.

\$xxGEN, hhhh, hhmmss.ss, hhhh[,hhhh], *hh<cr><lf>
 0 1 2 3 4

0) Header

1) Address of first group in sentence

Address of first group in GEN sentence. Address is represented in hexadecimal format in range 0x0000 through 0xFFFF.

The 16-bit address is formatted as fixed 4-character HEX field.

2) Time stamp

Time when status was valid.

3) Packed generic status group

The packed generic status group is represented as a 6-bit value.

The 16-bit value is formatted as fixed 4-character HEX field.

4) Optional repeat of field 3

Optional repeated packed generic status field. Each repeat increases the status address by one.

Up to seven repetitions yielding a total of 128 status bits per sentence is possible.

hh = Check sum

GNS - GNSS fix data

Fix data for single or combined satellite navigation systems (GNSS).

\$--GNS,hhmmss.ss,llll.lll,a,yyyyy.yyy,a,c--c,xx,x.x,x.x,x.x,x.x,x.x*x*hh<CR><LF>

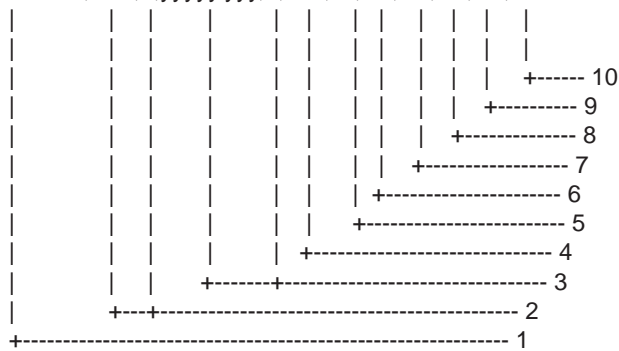

1. UTC of position
2. Latitude, N/S
3. Longitude, E/W
4. Mode indicator
5. Total number of satellite in use,00-99
6. HDOP
7. Antenna altitude, metres, re:mean-sea-level(geoid)
8. Geoidal separation
9. Age of differential data
10. Differential reference station ID
11. Checksum

HDG - Heading Magnetic

\$--HDG,x.x,x.x,x.a,x.x,a*hh<CR><LF>

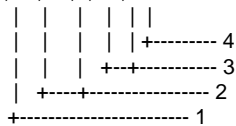

1. Magnetic sensor heading, degrees
2. Magnetic deviation, degrees E/W
3. Magnetic variation, degrees E/W
4. Checksum

HDT - Heading True

\$--HDT, x.x, T*hh<CR><LF>

\$--HDT,x.x,T*hh<CR><LF>

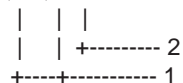

1. Heading, degrees true
2. Checksum

HSS - Hull stress surveillance systems (PAS 102)

0 1 2 3 4
 \$xxHSS, c--c, x.x, A, *hh<cr><lf>

0: Header 1: Measurement point ID 2: Measurement value

3: Data status, A = data valid, V = data invalid 4: Check-sum

Note: This must be verified by Ship Classification. VDR is required to log such data if HSS is fitted on ship.

HTC - Heading/Track control command

\$--HTC,A,x.x,a,a,a,x.x,x.x,x.x,x.x,x.x,x.x,x.x,x.x,a*hh<CR><LF>

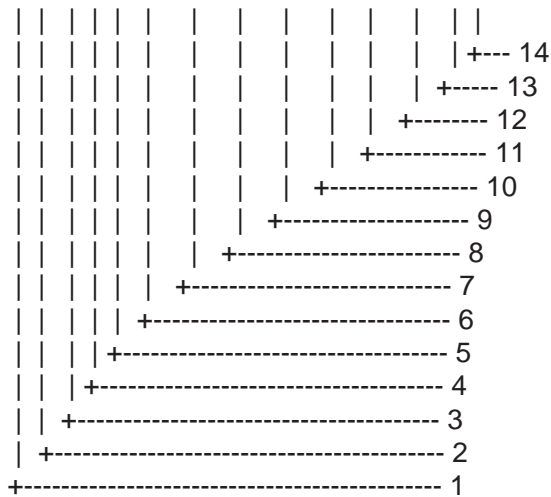

1. Override, A = in use, V = not in use
2. Commanded rudder angle, degrees
3. Commanded rudder direction, L/R = port/starboard
4. Selected steering mode
5. Turn mode R = radius controlled
 T = turn rate controlled
 N = turn is not controlled
6. Commanded rudder limit, degrees(unsigned)
7. Commanded off-heading limit, degrees(unsigned)
8. Commanded radius of turn for heading changes, n.miles
9. Commanded rate of turn to heading changes, deg/min
10. Commanded heading-to-steer, degrees
11. Commanded off-track limit, n.miles(unsigned)
12. Commanded track, degrees
13. Heading reference in use, T/M
14. Checksum

HTD - Heading/Track control data

\$--HTD,A,x.x,a,a,a,x.x,x.x,x.x,x.x,x.x,x.x,x.x,x.x,x.a,A,A,A,x.x*hh<CR><LF>

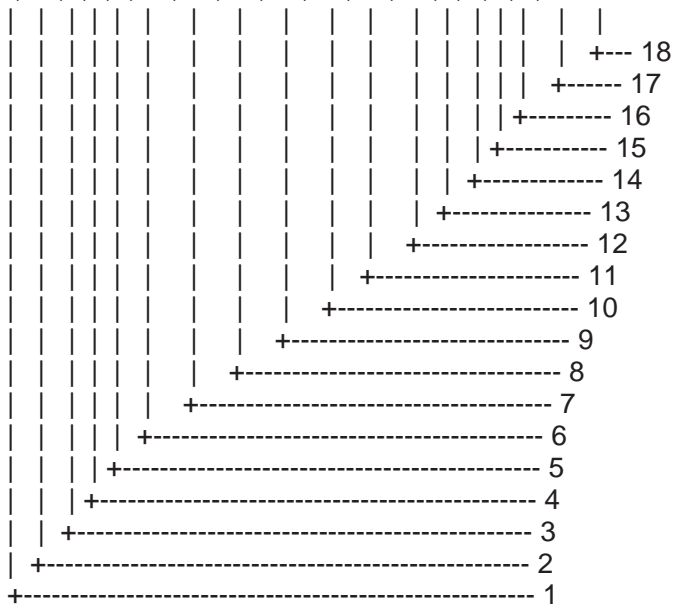

1. Override, A = in use, V = not in use
2. Commanded rudder angle, degrees
3. Commanded rudder direction, L/R = port/starboard
4. Selected steering mode
5. Turn mode R = radius controlled
 T = turn rate controlled
 N = turn is not controlled
6. Commanded rudder limit, degrees(unsigned)
7. Commanded off-heading limit, degrees(unsigned)
8. Commanded radius of turn for heading changes, n.miles
9. Commanded rate of turn to heading changes, deg/min
10. Commanded heading-to-steer, degrees
11. Commanded off-track limit, n.miles(unsigned)
12. Commanded track, degrees
13. Heading reference in use, T/M
14. Rudder status A = within limits, V = limit reached or exceeded
15. Off-heading status A = within limits, V = limit reached or exceeded
16. Off-track status A = within limits, V = limit reached or exceeded
17. Vessel heading, degrees
18. Checksum

MWV - Wind speed and angle (PAS 102)

When the reference field is set to relative, data is provided giving the wind angle in relation to the vessel's heading and wind speed, both relative to the moving vessel.

When the reference field is set to true, data is provided giving the wind angle relative to the vessel's heading and wind speed, both with reference to the moving water. True wind is the vector sum of the relative apparent wind vector and the vessel's velocity vector along the heading line of the vessel. If represents the wind at the vessel if it were stationary relative to the water and heading in the same direction.

\$--MWV,x.x,a,x.x,a,A*hh<CR><LF>

```
| | | | |
| | | | | +----- 6
| | | | | +----- 5
| | | | | +----- 4
| | | | | +----- 3
| | | | | +----- 2
| | | | | +----- 1
```

1. Wind angle, 0 to 359 (degrees)
2. Reference, R=relative, T=true
3. Wind speed
4. Wind speed units, K/M/N
5. Status, A=data valid, V=data invalid
6. Checksum

PRC - Propulsion remote control status

This sentence indicates the engine control status (engine order) on a M/E remote control system. This provides the detail data not available from the engine telegraph.

\$xxPRC, x.x, A, x.x, A, x.x, A, x, *hh<cr><lf>

0 1 2 3 4 5 6 7 8

- 0) Header
- 1) Lever demand position
-100 - 0 - 100% from "full astern" (crash astern) to "full ahead" (navigation full) "stop engine"
- 2) Data status
A = data valid
V = data invalid
- 3) RPM demand
- 4) Data status
R = relative (%): 0-100% from zero to maximum rpm
T = true (rpm): "-"Astern
V = data invalid
- 5) Pitch demand
- 6) Data status
R = relative (%): -100 - 0 - 100% from "full astern" (crash astern) to "full ahead" (navigation full) "stop engine"
T = true (degree): "-"Astern
V = data invalid
- 7) Number engine or propeller shaft
0 = single or on centre-line
Odd = starboard
Even = port
- 8) Checksum

RPM - Revolutions (PAS 102)

Shaft or engine revolution rate and propeller pitch.

\$--RPM, a, x, x.x, x.x, A*hh<CR><LF>

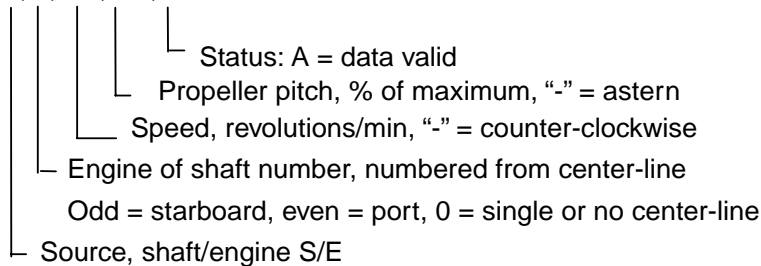

RSA - Rudder sensor angle

\$--RSA, x.x, A, x.x, A*hh<CR><LF>

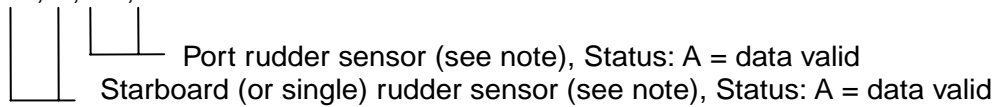

NOTE - Relative measurement of rudder angle without units, "-" = turn to port. Sensor output is proportional to rudder angle but not necessarily 1 : 1.

TRC - Thruster control data

This sentence provides the control data for thruster devices

\$xxTRC, x, x.x, A, x.x, A, x.x, *hh<cr><lf>

0 1 2 3 4 5 6 7

- 0) Header
- 1) Number of thrusters
 - Odd = Bow thruster
 - Even = Stern thruster
- 2) RPM demand
- 3) Data status
 - R = relative (%): 0-100% from zero to maximum rpm
 - T = true (deg) V = data invalid
- 4) Pitch demand value
 - "-" port
- 5) Data status
 - R = relative (%)
 - T = True (deg)
 - V = Data invalid
- 6) Azimuth demand
 - Direction of thrust in degrees (0 deg - 360 deg)
 - for thrusters capable of rotating direction of thrust
- 7) Checksum

TRD - Thruster response data

This sentence provides the response data for thruster devices.

\$xxTRD, x, x.x, A, x.x, A, x.x, *hh<cr><lf>

0 1 2 3 4 5 6 7

- 0) Header
- 1) Number of thrusters
Odd = Bow thruster
Even = Stern thruster
- 2) RPM demand
- 3) Data status
R = relative (%): 0-100% from zero to maximum rpm
T = true (deg) V = data invalid
- 4) Pitch response value
"-" port
- 5) Data status
R = relative (%)
T = True (deg)
V = Data invalid
- 6) Azimuth demand
Direction of thrust in degrees (0 deg - 360 deg)
for thrusters capable of rotating direction of thrust
- 7) Checksum

VBW - Dual ground/water speed: This sentence to be expanded as shown below:

\$--VBW,x.x,x.x,A,x.x,x.x,A,x.x,A,x.x,A*hh<CR><LF>

```

| | | | | | | | | | | |
| | | | | | | | | | | | +--- 11
| | | | | | | | | | | | +---- 10
| | | | | | | | | | | | +----- 9
| | | | | | | | | | | | +----- 8
| | | | | | | | | | | | +----- 7
| | | | | | | | | | | | +----- 6
| | | | | | | | | | | | +----- 5
| | | | | | | | | | | | +----- 4
| | | | | | | | | | | | +----- 3
| | | | | | | | | | | | +----- 2
| | | | | | | | | | | | +----- 1

```

- 1. Longitudinal water speed, knots
- 2. Transverse water speed, knots
- 3. Status: water speed, A=data valid V=data invalid
- 4. Longitudinal ground speed, knots
- 5. Transverse ground speed, knots
- 6. Status: ground speed, A=data valid V=data invalid
- 7. Stern transverse water speed, knots
- 8. Status: stern water speed, A=data valid V=data invalid
- 9. Stern transverse ground speed, knots
- 10. Status: stern ground speed, A=data valid V=data invalid
- 11. Checksum

VDM - UAIS VHF Data-link Message (IEC 61162-2, for AIS)

!--VDM,x,x,x,x,s--s,x*hh<CR><LF>

```
| | | | | | |
| | | | | | +--- 7
| | | | | +---- 6
| | | | +----- 5
| | | +----- 4
| | +----- 3
| +----- 2
+----- 1
```

1. Total number of sentences needed to transfer the message, 1 to 9
2. Message sentence number, 1 to 9
3. Sequential message identifier, 0 to 9
4. AIS channel Number
5. Encapsulated ITU-R M.1371 radio message
6. Number of fill-bits, 0 to 5
7. Checksum

VDO - UAIS VHF Data-link Own-vessel report (IEC 61162-2, for AIS)

!--VDO,x,x,x,x,s--s,x*hh<CR><LF>

```
| | | | | | |
| | | | | | +--- 7
| | | | | +---- 6
| | | | +----- 5
| | | +----- 4
| | +----- 3
| +----- 2
+----- 1
```

1. Total number of sentences needed to transfer the message, 1 to 9
2. Message sentence number, 1 to 9
3. Sequential message identifier, 0 to 9
4. AIS channel Number
5. Encapsulated ITU-R M.1371 radio message
6. Number of fill-bits, 0 to 5
7. Checksum

WAT - Water level detection (PAS 102)

This sentence provides detection status of water leakage and bilge water level, with monitoring location data. Malfunction alarm of the water level detector should be included in the "ALA" sentence.

\$xxWAT, A, hhmmss.ss, aa, aa, xx, xxx, A, c—c, *hh<cr><lf>

0 1 2 3 4 5 6 7 8 9

0) Header

1) Message type

S: Status for section: Number of faulty and activated condition reported as number in field 4.

The section may be a whole section (one or both of the division indicators are empty) or a sub-section. (If S is used then it shall be transmitted at regular intervals)

E: Status for each water level detector. (E may be used to indicate an event.)

F: Fault in system: If limited to one section, indicated by division indicator fields, if not, division indicators [empty]. (F may be used to indicate an event).

2) Time stamp

Time when this status/message was valid.

3) System indicator of alarm source

Indicator characters showing system detecting water level. The field is two characters.

4) Location (1)

Indicator characters showing detection location. The field is two characters.

5) Location (2)

Indicator characters showing detection location. The field is two characters.

6) Number of detection point or detection point number

Number showing high-water-level detecting point or the number of the water leakage detection point. This field is three fixed numeric characters.

7) Alarm condition

This field is a single character specified by the following:

N = normal state

H = alarm state (threshold exceeded)

J = alarm state (extreme threshold exceeded)

L = alarm state (Low threshold exceeded i.e. not reached)

K = alarm state (extreme low threshold exceeded i.e. not reached)

X = Fault (state unknown)

When S status indicated in 2nd field, this field is ignored

8) Descriptive text

Additional and optional descriptive text/level detector tag.

9) Checksum

XDR - Transducer measurements

Measurement data from transducers that measure physical quantities such as temperature, force, pressure, frequency, angular or linear displacement, etc. Data from a variable number of transducers measuring the same of different quantities can be mixed in the same sentence. This sentence is designed for use by integrated systems as well as transducers that may be connected in a "chain" where each transducer receives the sentence as an input and adds its own data fields on before retransmitting the sentence.

\$--XDR, a, x.x, a, c--c, a, x.x, a, c--c*hh<CR><LF>

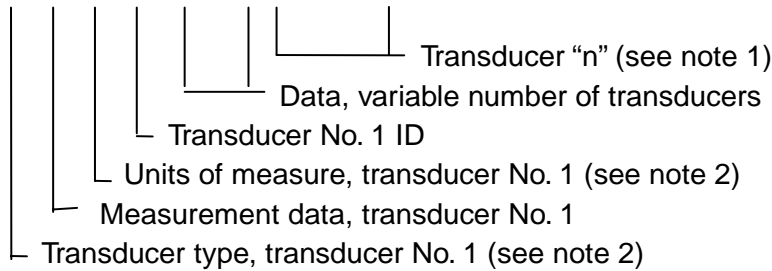

NOTES

1 Sets of the four fields "type-data-units-ID" are allowed for an undefined number of transducers. Up to "n" transducers may be included within the limits of allowed sentence length, null fields are not required except where portions of the "type-data-units-ID" combination are not available.

ZDA - Time and date

\$--ZDA,hhmmss.ss,xx,xx,xxxx,xx,xx*hh<CR><LF>

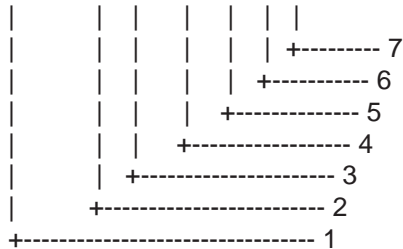

1. UTC
2. Day, 01 to 31(UTC)
3. Month, 01 to 12(UTC)
4. Year(UTC)
5. Local zone hours, 00h to +-13h
6. Local zone minutes, 00 to +59 as local hours
7. Checksum

NOTE - Zone description is the number of whole hours added to local time to obtain GMT. Zone description is negative for east longitudes.

5.2 Interface Circuits

5.2.1 IEC 61162-1

Data Collecting Unit

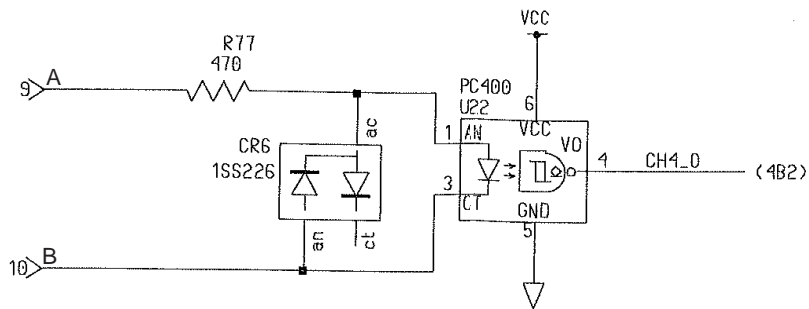

Junction Box

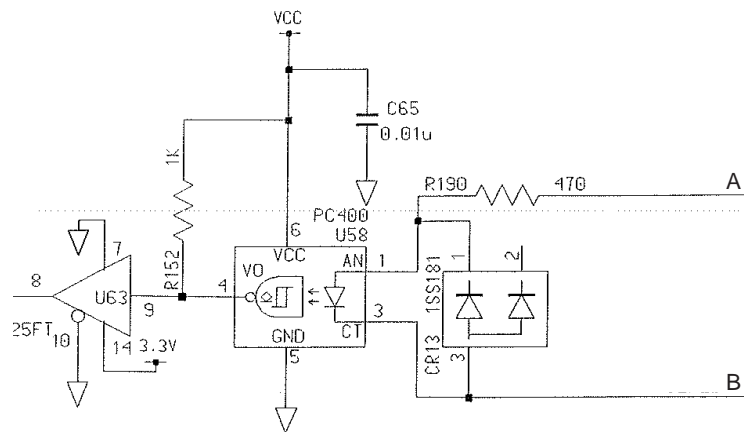

APPENDIX: PLAYING BACK RECORDED DATA

IMO Circulator SN Circ, 246 recommends that all VDR and S-VDR systems installed on or after 1 July 2006 be supplied with an accessible means for extracting the stored data from the VDR or S-VDR to a laptop computer.

Manufacturers are required to provide software for extracting data, instructions for extracting data and cables for connection between recording device and computer. FURUNO provides the following:

- LIVE PLAYER V4 (instructions)
- LIVE PLAYER V4 CD (software)
- Cables: Firewire and LAN

Refer to the Operator's Manual for the Live Player V4 for how to playback recorded data.

- 4.2 Frequency response Within 6 dB at 150Hz to 6 kHz
- 4.3 Audio coverage Cylindrical area of approx. 10 m in diameter
Distance: 2 m approx.
- 4.4 On-board beeper 1s in 12 hours period (built in)

5 JUNCTION BOX

- 5.1 Power Supply 24VDC from DCU
- 5.2 Interface
 - Serial IEC 61162-1/2: 2 ch, IEC 61162-1 (NMEA0183): 6 ch
 - Analog 16 ch ($\pm 10V$, 4-20mA)
 - Digital (a/b) 64 ch

6 POWER SUPPLY

100-230 VAC: 2.0-0.9A, 1 phase, 50/60 Hz
24VDC: 7.5A max.

7 ENVIRONMENTAL CONDITION

- 7.1 Ambient temperature
 - Data collecting unit -15°C to +55°C
 - Data recording unit -25°C to +55°C
 - Waterproof microphone -25°C to +55°C
 - Others -15°C to +55°C
- 7.2 Relative humidity 95% at 40°C
- 7.3 Waterproofing
 - Data collecting unit IP20
 - Data recording unit IPX6
 - Junction box/ Remote alarm panel IP20
 - Microphone IP20
 - Waterproof microphone IPX6
- 7.4 Vibration (IEC 60945) 2 - 5 Hz and up to 13.2 Hz with an excursion of ± 1 mm $\pm 10\%$
(7 m/s² maximum acceleration at 13.2 Hz)
13.2 - 100 Hz with a constant maximum acceleration of 7 m/s²

8 COATING COLOR

- 8.1 Data collecting unit N3.0 (standard)
- 8.2 Data recording unit Fluorescent orange (not changed)
- 8.3 Remote alarm panel N3.0 (not changed)
- 8.4 Microphone 2.5GY5/1.5 (not changed)
- 8.5 Waterproof microphone N9.5 (not changed)
- 8.6 Junction box N3.0 (standard)

Declaration of Conformity



0735

We **FURUNO ELECTRIC CO., LTD.**

(Manufacturer)

9-52 Ashihara-Cho, Nishinomiya City, 662-8580, Hyogo, Japan

(Address)

declare under our sole responsibility that the product

VOYAGE DATA RECORDER VR-3000

(Model name, type number)

to which this declaration relates conforms to the following standard(s) or normative document(s)

IMO Resolution A.861(20)	IEC 61996-1 Ed.1.0: 2007
IMO Resolution A.694(17)	IEC 60945 Ed.4.0: 2002
IMO Resolution MSC.191(79)	IEC 61162-1 Ed.3.0: 2007
IMO Resolution MSC.214(81)	IEC 61162-2 Ed.1.0: 1998
	IEC 62288 Ed.1.0: 2008

(title and/or number and date of issue of the standard(s) or other normative document(s))

For assessment, see

- EC type examination (Module B) certificate BSH/4612/4291517/09 issued by Federal Maritime and Hydrographic Agency (BSH), The Federal Republic of Germany.
- EC quality system (Module D) certificate No. BSH/4613/02206/1602/10 issued by Federal Maritime and Hydrographic Agency (BSH), The Federal Republic of Germany.

This declaration is issued according to the provisions of European Council Directive 96/98/EC on marine equipment modified by Commission Directive 2009/26/EC.

On behalf of Furuno Electric Co., Ltd.

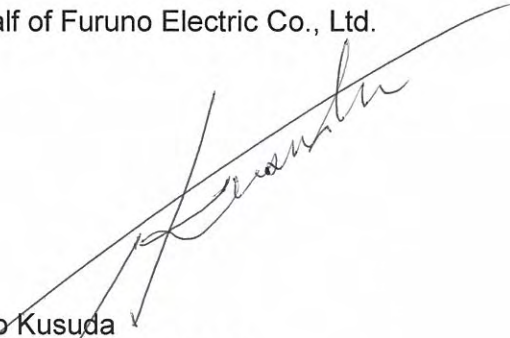
Takahiko Kusuda
Manager, QMS Secretariat
Quality Assurance Department

Nishinomiya City, Japan
November 8, 2010

(Place and date of issue)

(name and signature or equivalent marking of authorized person)

Declaration of Conformity



0735

We **FURUNO ELECTRIC CO., LTD.**

(Manufacturer)

9-52 Ashihara-Cho, Nishinomiya City, 662-8580, Hyogo, Japan

(Address)

declare under our sole responsibility that the product

SIMPLIFIED VOYAGE DATA RECORDER VR-3000S

(Model name, type number)

to which this declaration relates conforms to the following standard(s) or normative document(s)

IMO Resolution MSC.163 (78)	IEC 61996-2 Ed.2.0: 2007
IMO Resolution A.694 (17)	IEC 60945 Ed.4.0: 2002
IMO Resolution MSC.191(79)	IEC 61162-1 Ed.3.0: 2007
IMO Resolution MSC.214 (81)	IEC 61162-2 Ed.1.0: 1998
	IEC 62288 Ed.1.0: 2008

(title and/or number and date of issue of the standard(s) or other normative document(s))

For assessment, see

- EC type examination (Module B) certificate BSH/4612/4471518/09 issued by Federal Maritime and Hydrographic Agency (BSH), The Federal Republic of Germany.
- EC quality system (Module D) certificate No. BSH/4613/02206/1602/10 issued by Federal Maritime and Hydrographic Agency (BSH), The Federal Republic of Germany.

This declaration is issued according to the provisions of European Council Directive 96/98/EC on marine equipment modified by Commission Directive 2009/26/EC.

On behalf of Furuno Electric Co., Ltd.

Takahiko Kusuda
Manager, QMS Secretariat
Quality Assurance Department

Nishinomiya City, Japan
November 8, 2010

(Place and date of issue)

(name and signature or equivalent marking of authorized person)