



METEOROLOGICAL INSTRUMENTS

INSTRUCTIONS

**WIND TRACKER
MODEL 06206**





MODEL 06206 WIND TRACKER

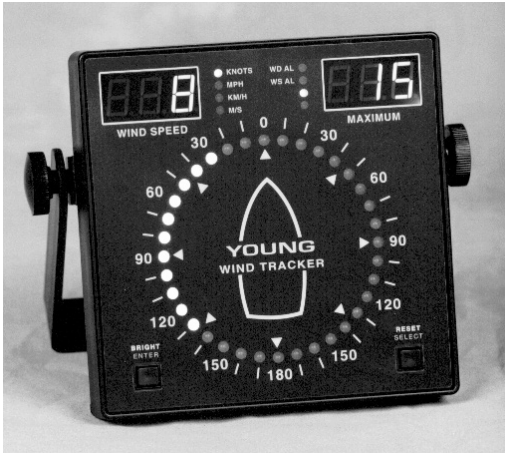

SPECIFICATIONS

Size:	144 mm (5.65 in) x 144 mm (5.65 in) x 36 mm (1.4 in)
Panel Cutout:	138 mm (5.43 in) x 138 mm (5.43 in)
Sensors:	Wind Monitor-MA (05), Wind Monitor (05), Wind Monitor HD (Hd), Wind Monitor-SE (SEr), Ultrasonic Anemometer (SEr), Wind Monitor-JR (04), Wind Sentry (03)
Accuracy:	±0.6% Full Scale
NMEA Serial Input & Output:	\$WIMWV, ddd, R, sss, u, A*c<cr><lf> ddd wind direction in degrees sss wind speed (ss.s for m/s) u units (N knots, K km/hr, M m/s, S statute mph) c NMEA checksum
Other inputs:	4-20 mA (0-360 deg, Ldi 0-50 m/s, Ld2 0-100 m/s)
Other outputs:	0-5 VDC = 0-360° or 0-540° 0-5 VDC = 0-100 m/s
Alarm Relays:	Normally Open contacts for WS and WD Contact rating 24 VAC or 30 VDC maximum 5A resistive, 2A inductive maximum
Input Power:	12-30 VDC, 3.5 W
Weight:	1.0 lb (0.45 kg) without AC adapter

INTRODUCTION

The YOUNG Model 06206 Wind Tracker is a compact wind speed and direction display with advanced features such as relative wind angle and NMEA serial I/O making it suitable for shipboard use.

FEATURES

- 3-digit wind speed display
- 3-digit maximum wind speed or wind direction display
- Multi-color wind direction display with variability
- Wind speed and direction alarms with delay
- RS-485/NMEA serial connections
- Calibrated 0-5 VDC outputs
- Display brightness control
- Compatible with YOUNG wind sensors & 4-20mA inputs

PRECAUTIONS

- **INDOOR USE ONLY!**
(Unless placed in approved enclosure)
- Operating temperature range:
0-50°C (32-122°F), 0-95% RH
- Use only recommended power sources.
(12-30 VDC, 3.5 W)
- Disconnect power when connecting or servicing
- Alarm contact rating 24 VAC/30 VDC,
(5 A resistive, 2 A inductive maximum)

MOUNTING AND START-UP

1. For best visibility, place the Wind Tracker in a location free of direct sunlight. Mount it using the attached bracket or remove bracket for flush mounting to a bulkhead or panel cutout. Panel cutout dimensions are given in the specifications. An optional rack mounting panel (Model 06280) and protective enclosure (Model 06260) are available from your YOUNG supplier.

2. Connect cables to terminals according to wiring diagram.

IMPORTANT NOTE! Please observe correct position of back panel Input Selector Switch according to wiring diagram.

3. Connect GND terminal to suitable earth ground.
4. Insert power supply plug into power jack, plug power supply into a suitable AC wall outlet or connect to suitable 12 to 30 VDC power source to terminals.

IMPORTANT NOTE! Do not connect more than one power source to the Wind Tracker at the same time.

5. When power is applied, the Wind Tracker will display firmware version number then begin to display wind information as follows:

- Wind speed
- Wind speed units
- Maximum wind speed or direction degrees
- Wind direction (single orange indicator)
- Direction variability (green indicators)
- Alarm status indicators (if selected)
- Wind speed & direction averaging indicator (if selected)

6. Observe display to confirm proper operation.

FRONT PANEL

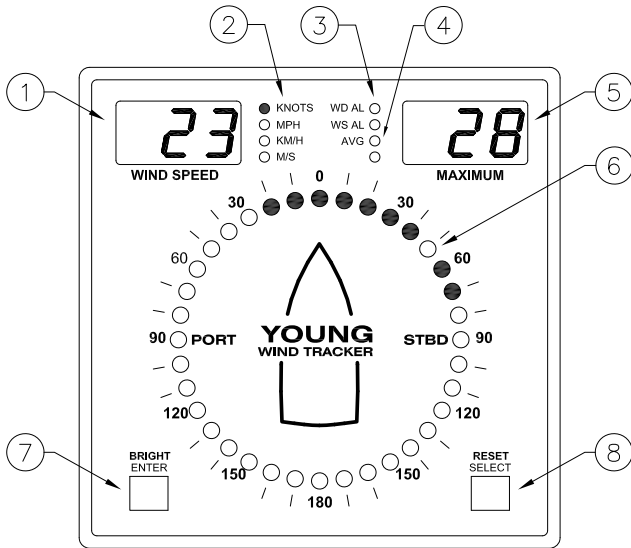

1. Wind speed display
2. Wind speed units indicator
3. Alarm status indicators
4. Data averaging indicator
5. Maximum wind speed or direction display
6. Wind direction and variability display
7. Brightness control (operate) or Enter key (setup)
8. Maximum Reset (operate) or Select (setup)

BACK PANEL

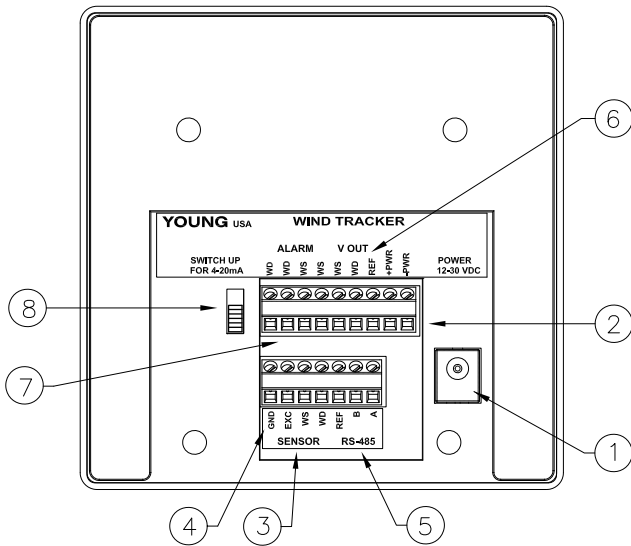

1. Power input coaxial jack (12-30 VDC)
2. Power input terminals (12-30 VDC)
3. Sensor or 4-20 mA inputs
4. Earth ground connection
5. RS-485 serial input/output
6. 0-5 VDC calibrated outputs
7. Alarm relay connections (Normally Open)
8. Input Selector Switch (Sensor or 4-20mA)

FACTORY DEFAULT SETTINGS

INPUT:

- Sensor Input Setting: "05" Wind Monitor
- Input selector switch position: "Down" (Sensor)

OPTIONS:

- Averaging: "No"
- Right hand display window: "Max Wind Speed"
- Alarms: "No"

OUTPUT:

- Voltage Outputs: 0-5Vdc=0-100m/s / 0-5Vdc = 0-360°
- NMEA Serial Output Rate: "FST"

IMPORTANT NOTE!:

Before connecting any external devices, verify the above settings are compatible with your application. If different, refer to the wiring diagrams in the back of the manual for the correct settings.

CHANGING SETTINGS

Marine Wind Tracker parameters may be inspected or changed in SETUP mode which is enabled by simultaneously pressing both **ENTER** and **SELECT** keys for about 4 seconds. When SETUP mode is active, abbreviations identify each function and available options as listed below. The **SELECT** key changes options or values. The **ENTER** key saves and moves to the next parameter.

Appearance of options depends on parameter settings. Some options may be hidden.

DISPLAY	SETUP FUNCTION
---------	----------------

InP	03	Wind Sentry
	04	Wind Monitor-Jr
	05	Wind Monitor
	SEr	NMEA serial input
	Ld2	Line Driver 4-20mA input (0-100 m/s)
Hd		Wind Monitor HD
	Ldi	Line Driver 4-20mA input (0-50 m/s)
SPd	unt	Wind Speed Units (annunciator blinks) SELECT key changes units. ENTER to save
		NMEA Serial Output Rate
Out	FSt	16 times per second
	SLO	Once per second
dSP	no	Display Averaging (annunciator blinks) Instantaneous data displayed
	YES	Average data displayed
PEr	030	Set averaging period in seconds (0-999). Display will update at this interval.
dSP	SPd	Right Display Window Selection Maximum wind speed
	dir	Wind Direction degrees
ALr	no	Wind Direction Alarm (annunciator blinks) Direction alarm not armed
	YES	Direction alarm armed
ALr	dir	SELECT key sets direction alarm sector start. ENTER key saves.
	SPn	SELECT key sets direction alarm sector span. ENTER key saves.

		Wind Speed Alarm (annunciator blinks)
ALr	no	Speed alarm not armed
	YES	Speed alarm armed
ALr	000	Alarm set-point. SELECT key increments value. ENTER key saves.
		Alarm Delay Time
dLY	030	Alarm delay time in seconds (0-999). SELECT key increments value. ENTER key saves.
		Sound
Snd	no	No sound
	YES	Audible beep with alarm activations or average update.
		Wind Direction Voltage Output Scale
dir	360	0-360 degrees
	540	0-540 degrees
		Test Functions
tSt	no	No test
	YES	Test
tSt	ALr	SELECT key closes alarm relays.
CAL	0.00	SELECT key alternates between 0.00 and 5.00 VDC output to calibrate external devices.
tSt	dsP	SELECT key tests display sections.

OPERATION

ALARMS

Wind speed and direction alarms each have their own set-point, LED status indicator, and relay contacts. The Alarm Delay parameter establishes time duration in or out of the set-point range needed for the alarm to change state. Front panel LEDs indicate alarm status during operation.

LED Off	=	Alarm not armed and OFF. Relay open
LED Steady	=	Alarm armed and OFF. Relay open
LED Blinking	=	Alarm armed and ON. Relay closed. Audible beep if Sound parameter is enabled.

AVERAGING

When averaging is enabled, the front-panel AVG annunciator is illuminated, and average wind speed and direction values are displayed at intervals set by the Period (PEr) parameter. When averaging is disabled, instantaneous wind values are displayed.

BRIGHTNESS

Adjust display brightness by pressing and holding the left BRIGHT key for 1 second.

MAXIMUM or WIND DIRECTION DISPLAY

Either MAXIMUM WIND SPEED GUST or numerical WIND DIRECTION appears during operation depending on Right Display Window (dSP) parameter setting. Maximum gust may be reset during normal operation by pressing and holding the RESET key for 1 second.

REMOTE DISPLAYS

The Marine Wind Tracker may be configured as a remote display by setting the Sensor Input for serial input (InP=SEr) and connecting the RS-485 terminals to a source providing a \$WIMWV NMEA wind speed and direction string. This may be any valid NMEA source including another Wind Tracker operating as a master, a Young wind sensor or interface sending the NMEA string, or a shipboard system.

With a Marine Wind Tracker as the NMEA source, use these settings:
 MASTER: Sensor InP = any non-serial device.
 REMOTE: Sensor InP = SEr

Connect one Wind Tracker master to up to 16 remote displays via the RS-485 terminals as shown in wiring diagrams. Remote Wind Trackers display exactly the same information as the master including alarm states. MAX RESET and all display features are controlled by the master unit only. Brightness can be adjusted independently at each Wind Tracker display.

VOLTAGE OUTPUTS

Calibrated voltage outputs for wind speed and direction are updated 16 times per second. Wind Speed 0-100 m/s = 0.00 to 5.00 VDC. Wind Direction may be scaled for either 0-360 or 0-540 degrees = 0.00 to 5.00 VDC by setting the Direction (dir) parameter.

4-20 mA INPUTS

The Wind Tracker accepts 4-20 mA Line Driver inputs with either 0-50 m/s or 0-100 m/s scaling (Ldi and Ld2 input settings). Connect as shown in wiring diagram. The back-panel switch labeled 4-20 mA must be in the UP position. 24VDC power is recommended for most 4-20 mA installations.

POWER CONNECTIONS

The Wind Tracker operates from a 12 to 30 VDC power source. Power may be connected via the coaxial jack or terminals. These are internally wired in together so DO NOT CONNECT MORE THAN ONE POWER SOURCE AT THE SAME TIME. See wiring diagrams for examples.

ERROR MESSAGES

Ldi	Err	4-20 mA (line driver) signal is missing or outside an acceptable range. Verify connections, signal, and 4-20 mA switch in UP position.
SEr	Err	Unit set to receive RS-485 serial signal (InP=SEr), but no serial data detected. Verify NMEA source is working. Verify connections.

EMC COMPLIANCE

This device complies with Part 15 of the FCC Rules. Operation is subject to the following two conditions: (1) this device may not cause harmful interference, and (2) this device must accept any interference received, including interference that may cause undesired operation.

This equipment has been tested and found to comply with the limits for a Class A digital device, pursuant to part 15 of the FCC Rules. These limits are designed to provide reasonable protection against harmful interference when the equipment is operated in a commercial environment. This equipment generates, uses, and can radiate radio frequency energy and, if not installed and used in accordance with the instruction manual, may cause harmful interference to radio communications. Operation of this equipment in a residential area is likely to cause harmful interference in which case the user will be required to correct the interference at his own expense.

This ISM device complies with Canadian /CES-001.
Cet appareil/ISM est conforme a la norme NMB-001 du Canada.

EN55011/CISPR 11, Group 1, Class B device
Class B equipment is suitable for use in domestic establishments and in establishments directly connected to a low voltage power supply network which supplies buildings used for domestic purposes.

Note:
Instrument measurements may be disrupted by conducted RF interference at 13, 35, and 54 MHz.

To meet EMC Compliance, a ferrite core (YOUNG 18500) must be installed on the wall adapter DC power cable. The cable must pass through the center hole of the choke at least 4 times, creating 3 loops around the outside as shown below.

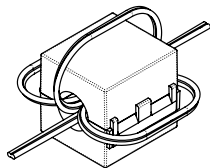

18500 FERRITE CHOKE

WARRANTY

This product is warranted to be free of defects in materials and construction for a period of 12 months from date of initial purchase. Liability is limited to repair or replacement of defective item. A copy of the warranty policy may be obtained from R. M. Young Company.

CE COMPLIANCE

This product has been tested and complies with European CE requirements for the EMC Directive. Please note that shielded cable must be used.



WIRING DIAGRAMS

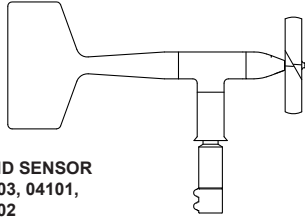

WIND SENSOR
05103, 04101,
03002

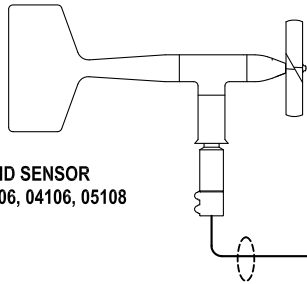
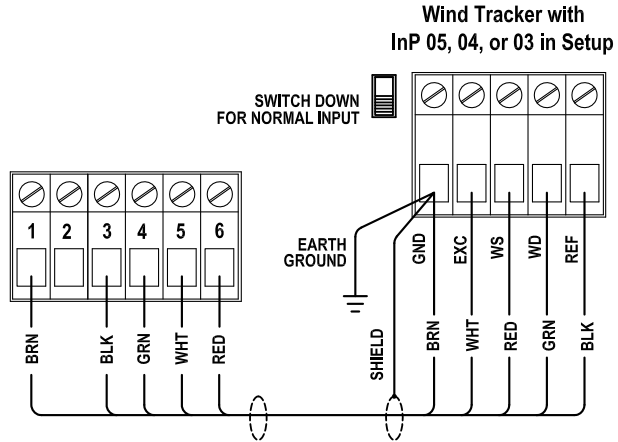

WIND SENSOR
05106, 04106, 05108

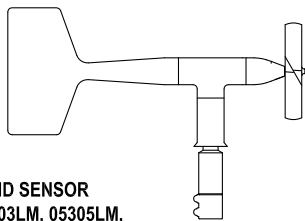
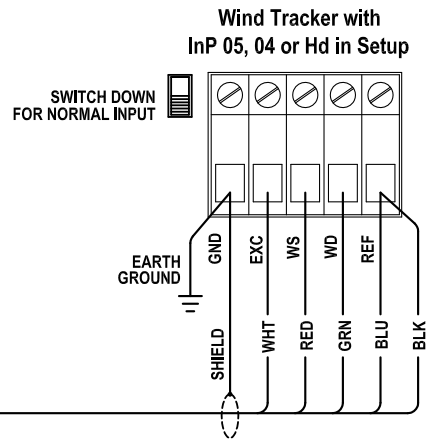

WIND SENSOR
05103LM, 05305LM,
04101LM, 03002LM
(0-50 m/s)

05103L, 05305L
(0-100 m/s)

4-20 mA OUTPUTS

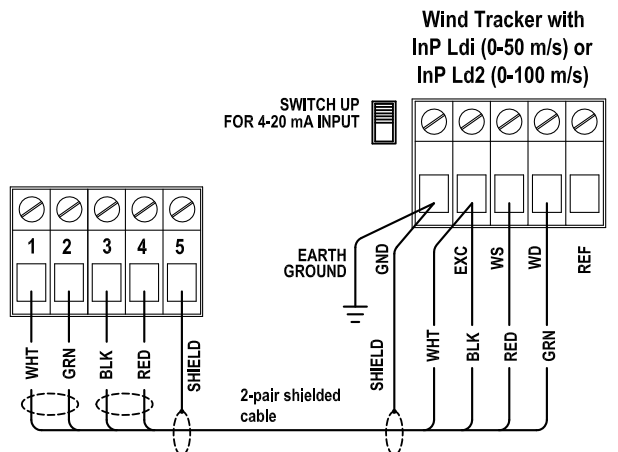



WIRING DIAGRAMS

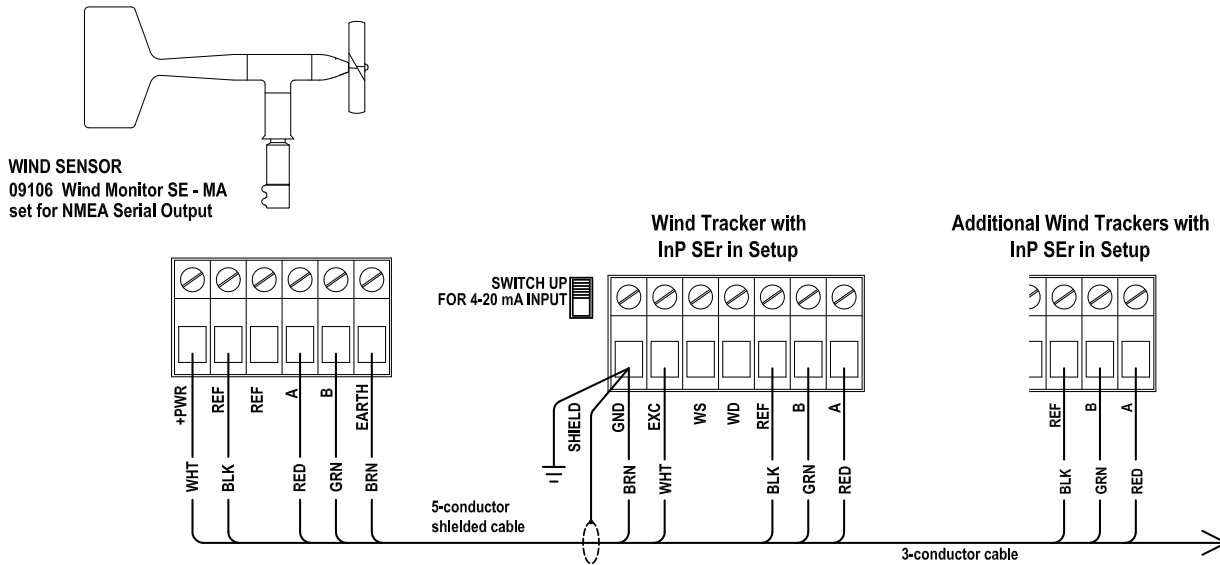
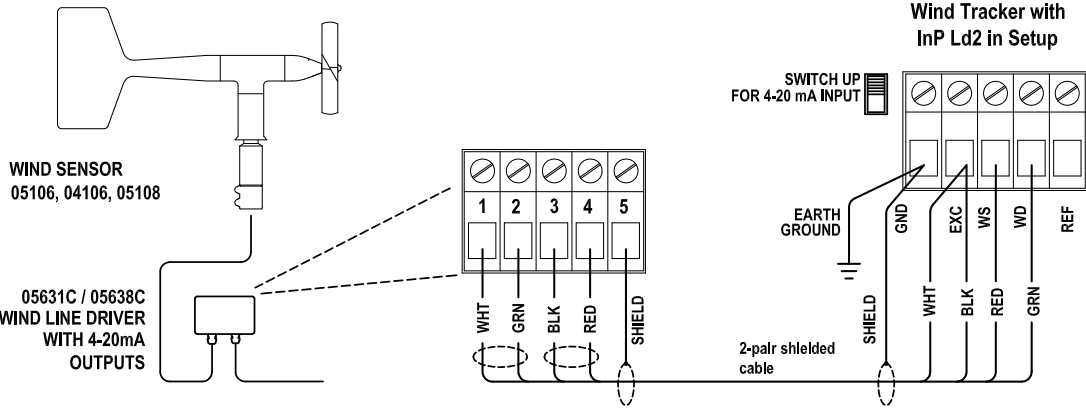



WIRING DIAGRAMS

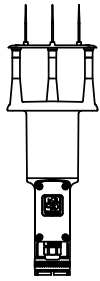

Model 86000 / 86106
Ultrasonic Anemometer

SENSOR SETTINGS:

Output Mode: RS-485 Output Only
Output Format: NMEA
Baud Rate: 4800

Use shielded cable.
Connect earth ground as shown.

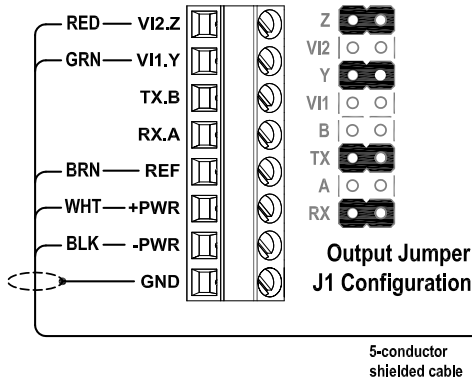

06206 Wind Tracker with
Inp SEr in setup

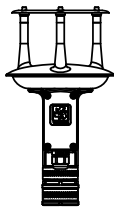
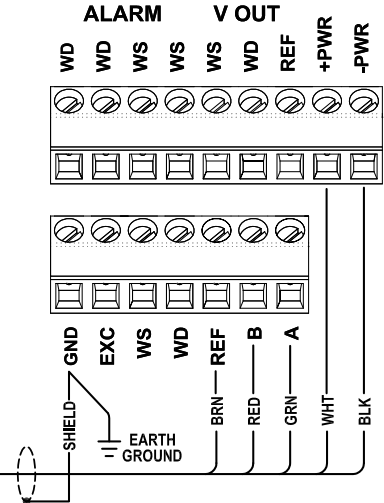

Model 91000
Ultrasonic Anemometer

SENSOR SETTINGS:

Output Mode: RS-485 Output Only
Output Format: NMEA
Baud Rate: 4800

These are the default sensor settings as shipped unless otherwise requested.
Use shielded cable. Connect cable shield to earth ground as shown.
(Color code is for Young 18446 Cable)

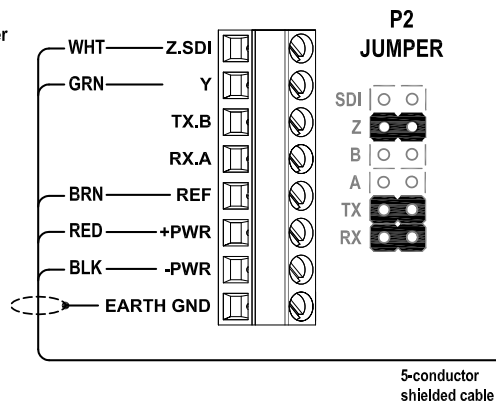

06206 Wind Tracker with
Inp SEr in setup

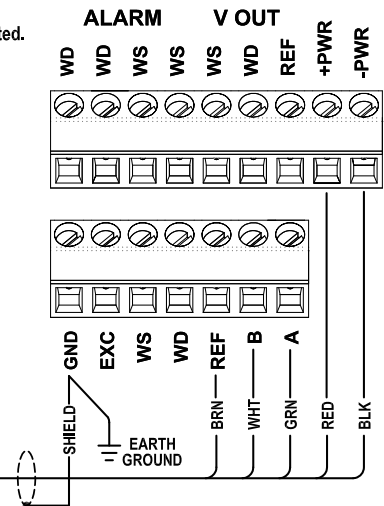



WIRING DIAGRAMS

Master-Remote Display Wiring Example

Master Wind Tracker with non-serial sensor Input

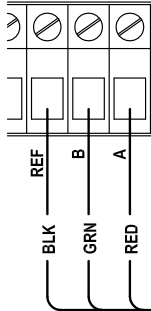

Remote Wind Tracker with InP SER in Setup

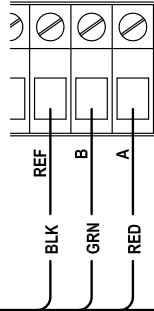

Remote Wind Tracker with InP SER in Setup

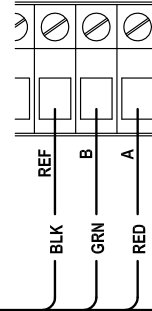

ALARM

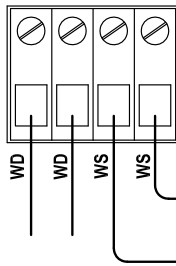

Alarm Device

User-supplied power for Alarm Circuit.
 Alarm contacts 24 VAC or 30 VDC maximum
 5 A resistive or 2 A inductive maximum

V OUT

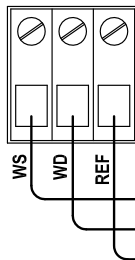

Wind Speed Vout, 0.00 to 5.00 VDC = 0 to 100 m/s
 Wind Direction Vout, 0.00 to 5.00 VDC = 0 to 360 or 540 degrees
 Vout Reference

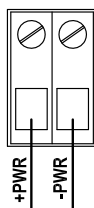

12 to 30 VDC, 3.5 watts max
 Power terminals are electrically parallel with coaxial power jack. Either may be used to supply power to Wind Tracker.

DO NOT CONNECT MORE THAN ONE POWER SOURCE AT THE SAME TIME.