

SIMRAD

Maris ECDIS900 System Operator Manual

ENGLISH



<http://www.navico-commercial.com/>

Preface

Disclaimer

As Navico is continuously improving this product, we retain the right to make changes to the product at any time which may not be reflected in this version of the manual. Please contact your nearest distributor if you require any further assistance.

It is the owner's sole responsibility to install and use the equipment in a manner that will not cause accidents, personal injury or property damage. The user of this product is solely responsible for observing safe boating practices.

NAVICO HOLDING AS AND ITS SUBSIDIARIES, BRANCHES AND AFFILIATES DISCLAIM ALL LIABILITY FOR ANY USE OF THIS PRODUCT IN A WAY THAT MAY CAUSE ACCIDENTS, DAMAGE OR THAT MAY VIOLATE THE LAW.

Governing Language: This statement, any instruction manuals, user guides and other information relating to the product (Documentation) may be translated to, or has been translated from, another language (Translation). In the event of any conflict between any Translation of the Documentation, the English language version of the Documentation will be the official version of the Documentation.

This manual represents the product as at the time of printing. Navico Holding AS and its subsidiaries, branches and affiliates reserve the right to make changes to specifications without notice.

Copyright

Copyright © 2017 Navico Holding AS.

Warranty

The warranty card is supplied as a separate document.

In case of any queries, refer to the brand website of your display or system: www.navico.com/commercial.

Regulatory statements

This equipment is intended for use in international waters as well as coastal sea areas administered by countries of the E.U. and E.E.A.

This system complies with:

- CE under EMC directive 2014/30/EU
- The requirements of level 2 devices of the Radiocommunications (Electromagnetic Compatibility) standard 2008

The relevant Declaration of conformity is available at the following website: www.navico.com/commercial.

The Wheelmark

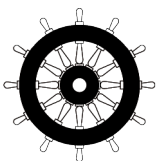

The Marine Equipment Directive 96/98/EC (MED), applies to all new ships, to existing ships not previously carrying such equipment, and to ships having their equipment replaced for ships flying EU or EFTA flags. This means that all system components covered by annex A1 must be type-approved accordingly and must carry the Wheelmark, which is a symbol of conformity with the Marine Equipment Directive.

This system is produced and tested in accordance with the European Marine Equipment Directive 96/98/EC

Navico has no responsibility for incorrect installation or use of the equipment, so it is essential for the person in charge of the installation to be familiar with the relevant requirements as well as with the contents of the manuals, which covers correct installation and use.

About this manual

The manual assumes that the user has basic knowledge of navigation, nautical terminology and practices.

Important text that requires special attention from the reader is emphasized as follows:

→ **Note:** Used to draw the reader's attention to a comment or some important information.

⚠ **Warning:** Used when it is necessary to warn personnel that they should proceed carefully to prevent risk of injury and/or damage to equipment/personnel.

Software version

This manual is written for the software version in effect at the date of release for this manual. The manual is continually updated to match new software releases.

The latest available manual version can be downloaded from www.navico.com/commercial.

What's New?

Release notes for ECDIS900 V3

This version describes new features and enhancements in relation to reliability, robustness, performance, and usability of the ECDIS900.

New features and enhancements	Description	Reference
C-MAP Chart database	An IEC 61174 Ed.4 approved chart module for SENC distribution which handles new requirements for: <ul style="list-style-type: none">• Viewing group management• Chart handling• Review update• Manual update	For installation and update, see " <i>C-MAP charts</i> " on page 78.
NYK Guard Zone settings	New predefined settings designed for NYK Group Management which caters different sailing conditions: <ul style="list-style-type: none">• Harbor/confined waters• Coastal waters• Open seas	See " <i>NYK Guard Zone settings</i> " on page 52 for more details.
ENC status report	Improvements in ENC status reports in accordance with IEC 61174 Ed.4.	See " <i>ENC status report</i> " on page 75 for more details.
Korean translation	New display language version of the ECDIS user interface	To change system language, see " <i>Switching display to Korean language</i> " on page 16.

Contents

9	Introduction
9	The ECDIS system
9	ECDIS requirement
10	System overview
11	System components
11	Software components
13	Hardware components
15	Basic operation
15	Start-up
15	Turning the system on and off
15	Adjusting display brightness
16	Set standard display
16	Changing workstations
16	Switching display to Korean language
16	Switching to Administrator mode
16	Service mode
17	Operation mode
17	Switching between charts
17	Zoom In/Out
18	Print screen
19	The user interface
19	The main window
19	Window title
20	Toolbar panel
21	Chart area
21	Console area
26	Security and system settings
27	ECDIS settings option
30	Tools for safe navigation
30	Man over board (MOB)
30	Adding an event
31	Selecting chart area
33	Center on ship
33	Auto centering
34	Targets
35	Loading/Unloading objects
35	Ship to point, range and bearing
35	Point to point, range and bearing
36	Ship to anchoring point, range and bearing
36	Modifying the ship properties
46	Show port list
46	Tide and current information
48	Weather
52	NYK Guard Zone settings
53	Ship profile management
53	Loading ship profile
53	Editing ship profile
53	Updating own ship data

54 Charts

- 54 Chart database installation
- 54 Electronic navigation charts (ENC)
- 78 C-MAP charts
- 84 ARCS

97 Routes

- 97 Creating route using keyboard
- 97 Creating route using mouse
- 99 Download from GPS
- 100 Modifying a route
- 101 Route properties
- 102 Route plan overview
- 106 Parallel index
- 106 Load, unload, and delete route functions
- 107 Synchronize a route between workstations
- 108 Upload routes by LAN
- 108 Check a route
- 110 Danger highlighting
- 111 Route options
- 112 Route status report
- 112 Route import and export functions
- 112 New route
- 112 Route plan
- 113 Route monitoring

120 Waypoints

- 120 Active waypoint information
- 120 Selecting waypoints
- 122 Waypoint properties
- 122 Plotting a waypoint outside the screen
- 122 Rename waypoints
- 123 Delete a waypoint
- 123 Move a waypoint in the list
- 123 Waypoint ETA information
- 123 Fixed ETA function
- 124 Waypoint arrival warnings and alarms
- 125 Change active waypoint
- 125 New waypoint by coordinates
- 125 New waypoint by bearing
- 126 Set a new waypoint latitude/longitude
- 126 Set a waypoint as a Pilot waypoint
- 126 Center the chart display on the waypoint location

127 Radar

- 127 Target display
- 127 Show and hide name
- 127 Show and hide past track
- 127 Save the track
- 128 Delete a target
- 128 Target properties
- 128 Manual target
- 128 Target prediction
- 129 Target list
- 130 Target window
- 130 MK Radar kit
- 131 Display settings
- 132 Target tracking

- 132 Tools
- 133 Known/common errors

135 Alert management

- 136 List of alerts
- 137 User defined alarm
- 139 Anchor watching
- 140 Harbor mode

141 Automatic Identification System (AIS)

- 142 Broadcasted data
- 142 Targets
- 143 AIS target display
- 144 Sleeping target
- 145 Target association
- 146 Lost target alert
- 147 Show and hide AIS target's name
- 147 Show and hide past track
- 147 Save the track
- 147 AIS target properties
- 147 Messages
- 149 AIS data server
- 149 SeaTrac

152 The Log book

- 152 Logbook settings
- 152 Displaying the logbook
- 153 New log entry
- 154 Loading a logbook
- 154 Replay
- 155 Print
- 155 New logbook record

156 Capture screen client

157 Master bridge assistant (MBA)

158 NAVTEX

- 158 Graphical display
- 159 Access to Navtex message

160 Editors overview

- 160 General tools
- 160 Selection
- 161 Edit menu
- 162 Navigation Editor
- 168 Object Editor

183 Predictor

- 183 Principle
- 184 Docking
- 185 Settings
- 186 Active leg window

188 SAR module overview

- 188 SAR symbols
- 191 Expanding square option
- 191 Parallel line option

192 Seismic module

- 192 Seismic data
- 195 Safety zone
- 196 Seismic module configuration

198 Annexes

- 198 Terms and abbreviations
- 200 Profile configuration parameters

202 Troubleshooting

- 202 Encryption scheme errors in ENC
- 203 Common errors in ARCS chart management

205 Maintenance

- 205 Weekly
- 205 Monthly

1

Introduction

The ECDIS system

This is a type approved Electronic Chart Display and Information System (ECDIS), and conforms to the International Maritime Organization (IMO) requirements for vessels that are subject to SOLAS regulations.

The system displays the vessel position, speed and course in real time on the chart, based on information received from navigational sensors. The vessel's symbol is displayed with actual heading, and speed vectors may also be indicated. Chart information critical to safe navigation defined by IMO will always appear on the display, while other chart information may be switched off.

Based on speed and course information, the system generates danger and grounding alerts, independent of mode of operation.

The system includes route planning, and routes are planned independent of the actual vessel position. The routes are checked for dangerous position of waypoints and legs as the route is planned. The routes are stored and may be recalled whenever necessary. The system has no limitations to the number of waypoints in a route.

Both hardware and software in the system are ECDIS type approved. The type approval certificates are available from the product site on www.navico.com/commercial.

The operational area of this ECDIS using ENC charts is between latitude 85° N and 85° S.

The International Hydrographic Organization (IHO) standards the system should meet are available at www.iho.int.

ECDIS requirement

According to the SOLAS convention three key components must be fulfilled if a vessel is to satisfy the chart carriage requirements in SOLAS by electronic means:

- The ECDIS must conform to the International Maritime Organization (IMO). To meet these requirements the system must be type approved
- The ECDIS system must have a back-up arrangement. This could be either a folio of paper charts or other non-paper, back-up solution decided by the relevant maritime administration.
- The charts used on the ECDIS system must be Electronic Navigational Charts (ENCs) following the standard set by the International Hydrographic Organization (IHO)

⚠ Warning: An ECDIS system is allowed to be used with non-approved charts. However, the use of the system with non-approved charts is limited to those areas where approved charts are not available. When non-approved charts are used, the ECDIS must be used together with an appropriate folio of up-to-date paper charts!

No ENC available, refer to paper chart
Sound is turned off

When using a non-approved chart, this message will appear.

System overview

The Simrad Maris ECDIS900 interfaces with navigational equipment in accordance and compliance with the IMO's ECDIS performance standards. It is designed to interface with other equipment that enhances the Watch Officer's ability to safely navigate and manage information. ECDIS900 is designed to work on Windows operating systems.

→ **Note:** Asterisk (*) indicates components that are mandatory for the ECDIS900 system.

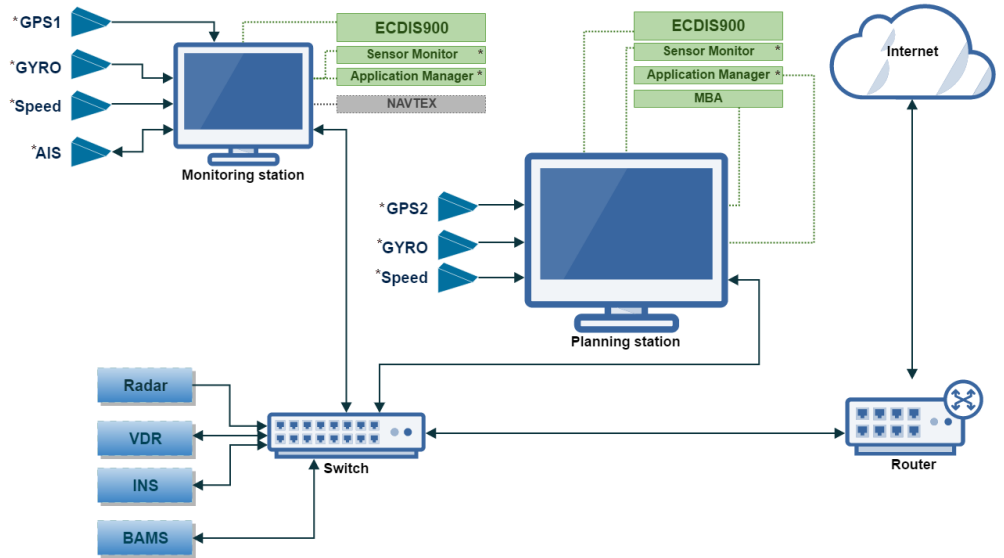

ECDIS900 can be connected to the Internet to utilize online chart update. The system is connected by using a shielded Ethernet RJ45 cable.

→ **Note:** To fulfill the ECDIS requirements, the system must be connected to internet through a firewall. To setup the firewall, refer to the MBA manual.

2

System components

Software components

Application manager

Application manager is a Windows shell that is installed by default on ECDIS computers. It enables users to manage and gain access to start menu, task bar and system trays. It also provides the standard desktop environment as well as graphical user interface for accessing the file management functions of the Windows operating system.

→ **Note:** The Application manager is automatically hidden on the right side of the window when not in used, click the extreme right side of the window near the console area to reopen it.

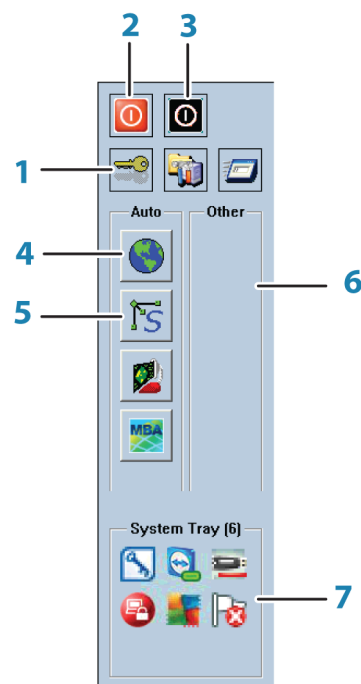

- 1 Security settings** button
Click once to display the security settings dialog. See "*Security settings*" on page 12 for more details.
- 2 Reboot the computer** button
Click once to restart the computer.
- 3 Switch off the computer** button
Click once to turn off the computer.
- 4 ECDIS900** button
Click once to open the running ECDIS.
→ **Note:** Users running in Operation Mode cannot terminate the ECDIS application unless the computer is switched off.
- 5 Sensor monitor** button
Click once to open the running Sensor monitor.
→ **Note:** Users running in Operational Mode cannot terminate the Sensor monitor unless the computer is switched off.
- 6 Other** pane
This is a section in the Application manager that enables users to see active applications that they can terminate.

7 System tray

Icons for other Windows applications that are not running in the foreground are shown here.

Security settings

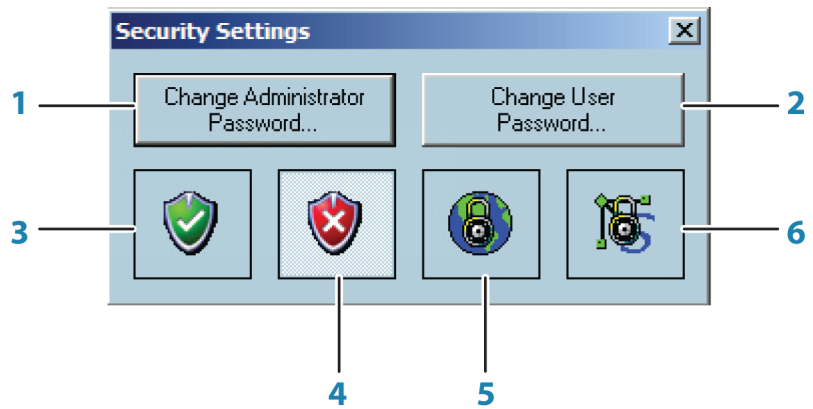

1 Change Administrator Password button

Click this button once to display the **Change password** dialog.



→ **Note:** Users running in Operation mode cannot change the Administrator password due to system user rights. To change passwords, select **Service mode** and log on with the correct Administrator user credentials. It is mandatory to input the old password before you can completely change it into a new one.

2 Change User Password button

Click this button once to change user passwords. This option is available for users running in **Service mode** or **Operation mode**.

→ **Note:** It is mandatory to input the old password before you can completely change the password.

3 Operation Mode button

Click this button to enable Operation mode. This is the default mode of the ECDIS system after the installation process.

See "*Operation mode*" on page 17 for more information.

4 Service Mode button

Click this button to switch to Service mode. This option is used by Admin user rights. See "*Service mode*" on page 16 for more information.

5 Lock/Unlock ECDIS button

Click this button to lock/unlock the ECDIS settings.

Refer to "*Security and system settings*" on page 26 for more details.

6 Lock/Unlock Sensor Monitor button

Click this button to lock/unlock the Sensor monitor settings.

Refer to "*Security and system settings*" on page 26 for more details.



Sensor monitor

Sensor monitor is an I/O software application which interfaces the ECDIS900 system. It is used to link and manage external devices like GPS, gyro, radars and other navigational sensors and reference systems. It enables users to manage data from navigational devices connected via serial, Ethernet or NMEA0183 communication ports. Sensor monitor is configured during the installation process of the ECDIS900 system. For more information regarding the configuration of the Sensor monitor, refer to Simrad Maris ECDIS900 System Installation manual.

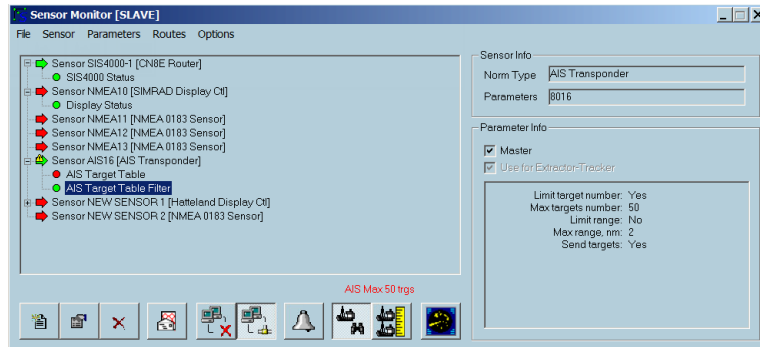

→ **Note:** Sensor monitor is running simultaneously with the ECDIS900 system, do not attempt to close the application as this will disable all sensor inputs.

Hardware components

ECDIS MK15 display and panel computer

The MK15 display and panel computers are designed by using Glass Display Control™ (GDC) touch technology to allow adjusting brilliance (brightness) and control power on/off with the use of illuminated symbols. These symbols are only visible when suitable power is connected. There is no physical moving knobs, pot meters, wheels or push buttons available as everything is touch surface controlled by Projected Capacitive technology, that allows a human finger (including several types of gloves) to control the unit.

ECDIS MK5 computer

MK5 computer is an Intel quad core (Central Processing Unit) CPU with HD graphics. This standard CPU has a DVD drive, 2 display port connectors, 1 serial port VGA, 2 USB ports, 1 USB LAN port and 4 (RJ45) LAN ports.

MK5 monitors

The ECDIS900 MK5 system includes various display sizes. The monitors are non-touch monitors, color calibrated and type approved for ECDIS.

A separate manual is delivered with the monitor. This manual includes installation and operational instructions.

Trackball

The wireless trackball is used as a pointing device to select ECDIS system menus and dialogs.

Alarm Panel

The Alarm panel is the audio source for the system. The unit gives an audible and a visual alert for any faults from the system, including power supply failure. Audible alerts are mandatory for any systems requiring Wheelmark certification.

Chart database

The system is designed for using approved ENC charts in S57 or S63 formats. A world-wide overview chart is pre-installed in the system. During installation and setup of the system the required and detailed charts must be installed.

For details about chart installation procedure, refer to "*Chart database installation*" on page 54.

USB DVD drive

The USB DVD drive is used to install chart permits and database.

Keyboard

The keyboard is used to input alphanumeric characters into the ECDIS system.

SIS4000 MK2

SIS4000-Mk2 is a network based module. This unit is a gateway between standard LWE IEC 91162-450 Ethernet bridge networks and standard NMEA 0183/IEC 61162-1/-2 interfaces.

NMEA 0183 4-port expansion module

It is a USB type interfacing device which is used to connect equipment such as GPS, gyro, log, ARPA, wind, echo sounder etc. This is normally designed to be connected at the back of the ECDIS computer unit.

This device is optional and is sold separately.

3

Basic operation

Start-up

The ECDIS900 system is switched on by pressing the external power switch of MK15 or MK5 computers.

The system should be left with the power ON.

When power is switched on, the operating system will be started, automatically followed by the system program.

When the system is switched on after the first-time initialization, the system will start with the settings that were active when the system was turned off.

Turning the system on and off

→ **Note:** Always let the system boot completely up before shutting it down to avoid system failure.



Power on

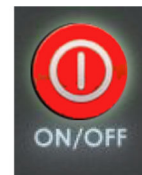

Power off

For ECDIS900 MK15, you turn the system on and off by touching the illuminated **ON/OFF** button located in front of the unit. This powers on both the monitor display and the internal processor.

→ **Note:** The ON/OFF button will change to green when the system is turned on and will change to red when the system is turned off.

For ECDIS900 MK5, you turn the system on and off by pressing the power button of the central processing unit (CPU). This powers on the internal ECDIS processing unit.

The monitor unit is power independently. Refer to the operator manual of your monitor for more details.

Adjusting display brightness

Warning: The use of brightness control may inhibit visibility of information particularly when using the night colour tables. Adjust the night display of the display screen by contrast control and not by brightness control.

Brilliance

For MK15, the display brilliance is adjusted by touching the illuminated plus (+) and minus (-) symbols on the panel computer. The entire area of text and symbols are visible as long as the unit is powered. Note that only the (-) and (+) are touch sensitive while the and BRILLIANCE symbols are not.

For MK5, the display brilliance is adjusted by pressing plus and minus keys on the monitor.

The monitors are color calibrated from factory, and has its individual backlight brightness set point in accordance with the ECDIS standard.

→ **Note:** For MK5, ECDIS approved brilliance setting is indicated with a green indicator in the BRILL shortcut button. If the brilliance is changed on the monitors, the indicator changes to yellow. You return to ECDIS approved brilliance settings by selecting the BRILL shortcut button.

→ **Note:** For MK15, ECDIS approved brilliance setting is indicated with the word ECDIS which is constantly illuminated in green as long as the unit is turned on. The (+) and (-)

symbols will illuminate in red when the brightness is adjusted either above or below ECDIS factory calibration point.



Set standard display

Click the icon once or press **F7** to enable the standard mode of the ENC display.

- **Note:** When the system is using ARCS chart, clicking this icon will also enable the system to display the original ARCS chart scale.
- **Note:** Switching to the Standard display mode automatically changes the backlight to the calibrated values if they are different from currently used brightness calibration. Left click adds standard brill/brightness to the standard display mode. The action is performed for all color schemes switching (day, dusk, night).

Changing workstations

A typical installation of an ECDIS900 network includes two or three workstations connected by Local Area Network (LAN). A **Monitoring** workstation which is designed for comprehensive and flexible voyage planning, route planning and chart management and a **Planning** workstation which is primarily designed as a back up workstation.

To change workstations, right double click the window title bar and select **Set as Planning station** or **Set as Monitoring station**.

- **Note:** One of the ECDIS in the network is predefined as Monitoring Station and acquires Position, Gyro and Log data via serial lines. A secondary Position, Gyro and other sensor data inputs through the Planning Station. All serial sensor inputs are broadcast on the network and shared by the two ECDIS stations.

Switching display to Korean language

To change the display language of the ECDIS system to Korean language, double right click the title bar and select **Switch to local language**.

- **Note:** This option changes the language Windows uses to display text, dialog boxes, menus, and other items in the ECDIS user interface.

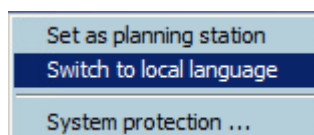

Switching to Administrator mode

Application manager is configured during the ECDIS system installation. Operating in Administrator mode enables users to modify user settings, run the standard Windows applications and use additional Windows features. Administrator mode is enabled and used when modifying the ECDIS settings.

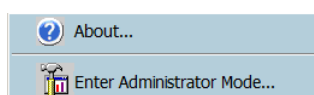

- **Note:** To switch the application to the Administrator mode, right click under the System tray area and select **Enter Administrator Mode...** from the dialog. This mode should only be enabled and used by certified technicians or users with an advanced skills in the relation to ECDIS system.

Service mode

This mode enables users to access the standard Windows functionality but disables users to modify the ECDIS computer settings.

Operation mode

This is the default operating mode of the Application manager running in an ECDIS computer. In this mode the ECDIS computer is protected against users modifying computer settings or installing third party software which may affect the operating system. Users running on this mode will only have access restricted to mandatory ECDIS functions and to other MARIS applications which are selected during the configuration.

→ **Note:** Application manager on an Approval mode supercedes Windows explorer thus, all Windows basic and standard shortcuts such as Ctrl+Alt+Del are disabled.

Switching between charts

To switch charts, right click on the current chart area to display the pop-up menu. Hover your cursor to **Other charts** option and select the chart database you want to use.

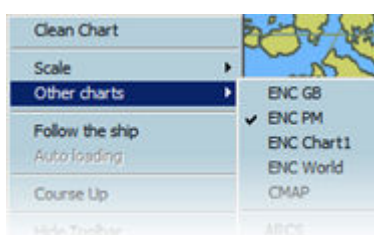

You can also press **F9** key from the keyboard to select another type of chart database. Pressing the **F9** key will only select chart database that are configured in the quick switch option.

Quick switch

To display and configure quick switch between chart types, press **CTRL** key and **F9** key simultaneously. Check/uncheck the chart type and click the **OK** button to apply the changes.

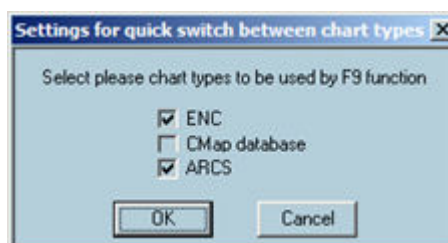

→ **Note:** Only installed charts will be displayed in the list. Open **Chart handling** dialog to see all chart databases installed in your system.

Zoom In/Out

→ **Note:** Mariners should exercise caution when modifying the chart scale. Over scaling (OVSC) is possible however some hazards to navigation may not be shown due to the limitations imposed by original chart scale.

Press **F1** key to zoom in or click the **Zoom in** icon to increase the size of the displayed chart. Press **F2** key to zoom out or click the **Zoom out** icon to decrease the size of the displayed chart.





Clean Chart	
Scale	1:30 000 000
Other charts	! 1: 12 000 000
Follow the ship	1:15 000 000
Auto loading	1: 8 000 000
Course Up	✓ 1: 2 948 868
Hide Toolbar	! 1: 1 500 000
Hide Console	! 1: 1 000 000
Chart settings	1: 700 000
Properties	1: 500 000
Check received Updates	1: 250 000
Manual update	1: 150 000
Display updates in area	1: 100 000
Objects under the point	1: 70 000
	1: 45 000
	1: 30 000

The list of scales displayed in the static information console depends on the chart type being used. Check mark ✓ indicates that the scale is currently used while exclamation mark ! indicates that an ENC cell with this compilation scale is installed and available.

Navigators should always check the approved scale before use and during route monitoring.

→ **Note:** Zoom in/out function should only be used for short periods of time.

Print screen

Print screen allows you to screenshot, screen capture or take a picture of the entire ECDIS screen.

To print screen, click on the **Print** icon from the toolbar panel.

The system will automatically generate a screen image and convert it into pdf format.

You can save the image into a removable drive or in the local drive of the ECDIS computer.

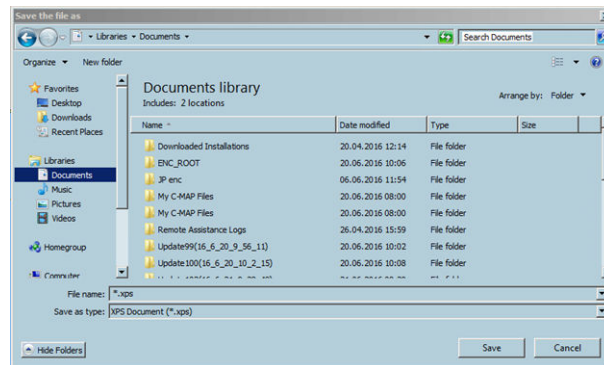

→ **Note:** The captured image cannot be opened if there is no PDF reader software installed in the ECDIS computer.

4

The user interface

The main window

The main window is divided into predefined areas as shown in the figure below.

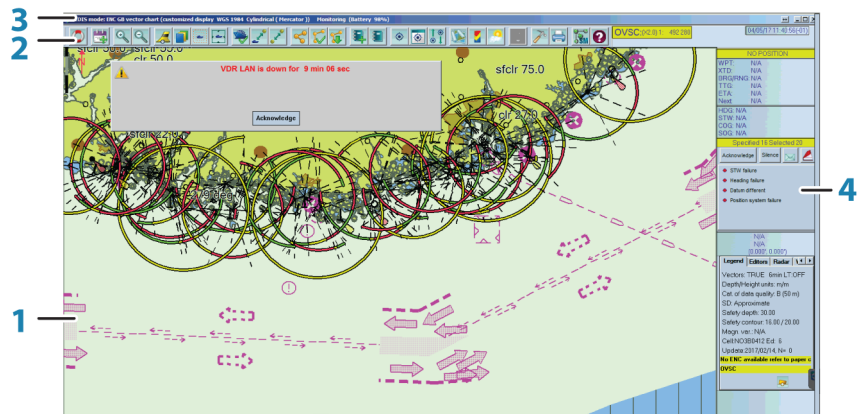

- 1 Chart area
- 2 Toolbar panel
- 3 Window title
- 4 Console area

Window title

The window title is a section on top of the main window which displays the name of the application.

When ECDIS mode is active, the name of the currently used chart database will be displayed (Example: S57 HO ENC, RCDS or CMAP)

ECDIS mode: HO ENC vector chart (full information display WGS 1984 (Global Definition) Cylindrical) Monitoring (Battery 100%)

RCDS mode: Oslofjorden - Southern Part (3159) - European 1950 (-0.03, -0.08) Monitoring

When S57 ENC or C-MAP chart is active, the following information will be shown in the title bar:

- Type of layer display
- Currently used datum
- Type of projection
- Type of ECDIS workstation

When raster chart is active, the following information will be shown in the title bar:

- Name of the active chart
- Chart number
- Datum of the chart
- Datum shift with WGS84
- Type of ECDIS workstation

→ **Note:** A battery charge indicator will be displayed in the title bar if ECDIS is installed in a laptop.

Toolbar panel

The **Toolbar** panel provides quick access to common functions directly related to the watch officer's duties.



Man over board icon



New logbook record icon



Event icon



Logbook icon



Zoom in icon



Set manual target icon



Zoom out icon



Target table icon



Standard Display icon



Target prediction icon



Select Area icon



Chart handling icon



Auto centering icon



Left click: **Show/Hide Tide stations and ocean current**

Right click: **Tide stations**



Centre on Ship icon



Weather handling icon



Left click: **Ship properties**

Right click: **Ship profiles**



Left click: **Show ports**

Right click: **Port list**



Left click: **Conning to point, range and bearing**

Right click: **Bow to point range and bearing**



Options icon



Point to point range and bearing icon



Print icon



Left click: **New route**

Right click: **SAR**



Activate Sensor Monitor (SM) icon



Route plan icon



Help icon



Load/Unload objects icon

Chart area

Chart area is a graphical representation of vector or raster charts based on IEC standards. This enables users to view all aspects of safety, interoperability, efficiency, compatibility and environmental impact of ECDIS900.

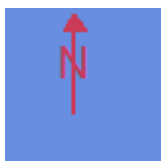

North symbol

The North symbol enables users to view that the top of the chart is the true north not a magnetic north towards which a compass points. It is always displayed the top left corner of the chart area.

→ **Note:** If the North direction is not the same for all displayed charts, then the North direction is dependent on the position and location of the vessel.



Console area

The console area contains number of different data displays, indicators, and panels, such as ship position, speed and direction, active waypoint, time and scale.

The console area settings are password protected. Refer to "*Security and system settings*" on page 26 for more details.

When the settings are available for editing, the following parameters can be changed:

- show and hide panels
- change color, size, and name of fonts
- freeze and unfreeze the current console configuration.

To modify the settings, refer to "*Configuring console options*" on page 27.

The navigation mode indicator shows the current navigation mode. For more details, see "*Navigation mode panel*" on page 22.

The time indicator displays the local time and gives access to the time dialog. For more details, see "*Time indicator*" on page 21.

The scale indicator displays the current scale of the chart and indicates whether the chart is overscaled or not. Refer to "*Scale indicator*" on page 22 for more details.

The wind indicator displays the alphanumeric values of the wind (True or Relative). The depth indicator displays either the depth under the keel, the Transducer or the surface according to user's selection. Refer to "*Other panels*" on page 23 for more details.

The alarm panel displays alarms and warnings, and includes the alarm acknowledge function.

The legend panel displays a legend and information about the loaded S57 cells under the ship's position and provides indication for **Better chart exists** and **NON-ENC data on display**. For more details, see "*Legend panel*" on page 24.

The editors panel gives access to edition tools to work on the electronic chart and with a used defined data. Refer to "*Editors overview*" on page 160 for more details.

The route monitoring panels enables users to manage active waypoints, determine the fixed ETA, and manage waypoint ETA. Refer to "*Route monitoring*" on page 113 for more details.

Time indicator

The time information is displayed in the **Time** panel.

ECDIS900 operates and displays the local time, which is calculated from UTC time and time zone information.

The mariner is responsible for the manual selection of the time zone.

The mariner can adjust the UTC time manually or choose UTC time to be automatically adjusted from the GPS.

→ **Note:** The ECDIS900 time format is encoded and is not linked with the Windows settings. ECDIS900 always displays the local time with the time zone information.

Route and local time

According to the time zone map, ECDIS900 automatically assigns a time zone for each waypoint and calculates the ETA in local time.

→ **Note:** The mariner can manually adjust the time zone for each waypoint. To modify the time zone, refer "*Waypoint properties*" on page 122.

Use PC time option

Tick on/off the **Use PC Time** check box to synchronize Windows time settings with ECDIS900.

Scale indicator

Current scale

Displays the current scale of the chart. The panel can be located in the console area or in the toolbar area.

Below is an example of an approved scale view:

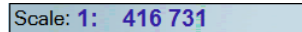

Overscale

If the current scale is two times larger than the compilation scale of the ENC cell, the scale panel displays an overscale warning. The panel is highlighted in yellow and OVCS message is displayed.

The overscale rate is displayed in the brackets.

If the rate is less than two (2), the standard scale panel is highlighted in yellow.

Below is an example of an overscale view:

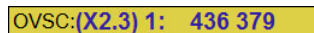

The overscale warning is also displayed on Legend panel. Refer to "*Legend panel*" on page 24 for more details.

→ **Note:** Other scale warning also displays the **Better chart exists** message. This message is displayed in the Legend panel normally for ships with ENC cell charts that has larger scale than the current chart in use.

Navigation mode panel

GPS mode

The GPS or D.R. (Dead Reckoning) panel displays the current navigation mode.

The default standard mode is the GPS mode. The GPS name and data quality bar are displayed on the panel.

If no data is received, the system switches to the D.R. mode and the **NO POSITION** warning message is displayed.

Once the communication with the GPS is restored, the system reverts to the GPS mode.

Multi GPS

ECDIS900 can receive data from several GPS devices. In this case, one of the GPS must have the Master role.

To change the Master GPS, right click on the panel and select GPS from the menu.

If the Master GPS data has worse quality than one of the slave GPS, the GPS panel is highlighted in yellow. It is recommended to switch to the GPS with best received data.

→ **Note:** The mariners are enable to change the Master GPS in the Monitoring station only. Master GPS is synchronized in the all ECDIS workstations connected to the network.

Simulation mode

When the GPS fails and no log/gyro data are available, the system switches to the simulation mode and the **NO POSITION** warning message is displayed.

The ship position panel displays dotted line and a red cross on top of the ship's icon indicates the simulation. The **S** symbol is displayed on the chart area.

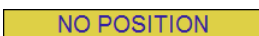
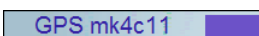

REPLAY

Replay mode

The Navigational panel switches to Replay mode when VDR Replay or a logbook replay is activated. Refer to "Replay" on page 154 for more details.

Other panels

Safety contour panel

When vector charts are in use, two different depth values are displayed in the Safety contour panel:

- The safety contour value that is selected and added by the mariner.
- The safety contour that is available in the chart cell located under the ship's position.

→ **Note:** If ECDIS does not find a safety contour equal to the selected value, it selects the contour with the nearest bigger value.

Specified 10 Selected 10

To change the value for safety contour, refer to "Chart depths" on page 60.

Wind panel

The wind panel displays either True or Relative values of the wind.

Right click on the panel and select the setting. Select **Show wind indicator** from the menu to display the wind indicator in the chart area. Drag and drop to set the proper location in the chart area.

Wind T: N/A

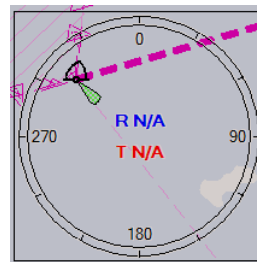

→ **Note:** The indicator is transparent.

Depth panel

The depth panel displays either the depth below transducer, below the keel or below the surface.

To switch between the values, right click in the panel and select the appropriate item menu.

Waypoint panels

For a complete description of the different panel related to waypoint and route monitoring, refer to "Route monitoring" on page 113.

Target panel

Click on a target to select it. The target panel displays information of the selected target.

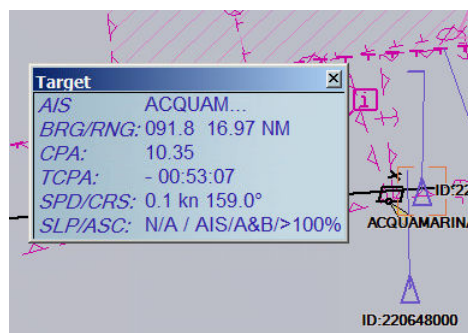

Tools panel

The Tools panel consists of the following tabs:

- Legend
- Editors
- Radar
- Weather
- Active leg

Click on the tab name to switch between Tool panels.

Legend panel

The **Legend** panel displays information about the loaded ENC cells or raster chart under the ship's position and indicate some alerts.

It also enables users to view the following:

- The vector type (True/Relative)
- The depth and height units
- Quality of the data
- The sounding datum
- Safety depth information
- The safety contour information
- The magnetic variation
- Edition number and cell name in the center of the screen
- The last applied ENC update
- Indications and warnings

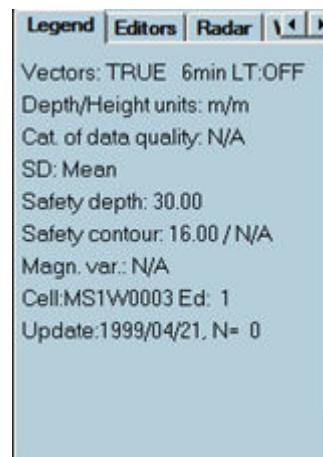

Quality of the ENC data

- A11: Chart of 5m accuracy with sea floor coverage
- A21: Chart of 20m accuracy with sea floor coverage
- B01: Chart of 50m accuracy from standard survey
- C01: Low accuracy or incomplete chart
- D01: Unreliable chart
- U01: Chart with quality not assessed

Indications warnings





The warnings can be indicated with highlighted texts and icons that are displayed in the Legend panel.

Warnings can be as follows:

- An **Overscale** message indication that is displayed when the chart is overscaled.
- A **Better chart exists** warning message that is displayed when the ship position is covered by an ENC at a scale larger than the scale provided for the display.
- When the displayed area includes waters for which no HO ENC is available, the area is symbolized with green color which means that the mariner has to refer to the paper charts.

- An **ENC data available** warning that is displayed when ARCS is used in an area where ENC data is available under the ship position.

The following icons are displayed in the event a setting is reconfigured:

Icon	Description
	CPA/TCPA monitoring is OFF
	Standard display is customized
	Danger monitoring is OFF
	Danger display is OFF
	Chart date is different from the current system date

5

Security and system settings

System username and passwords

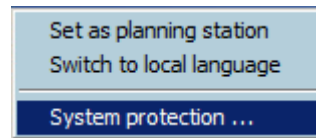

This option enables mariners to manage passwords and protect the Sensor monitor and the ECDIS system.

Double right click the Window title bar and select **System protection** to display the **Security and system protection** dialog. The system will prompt a dialog similar below:

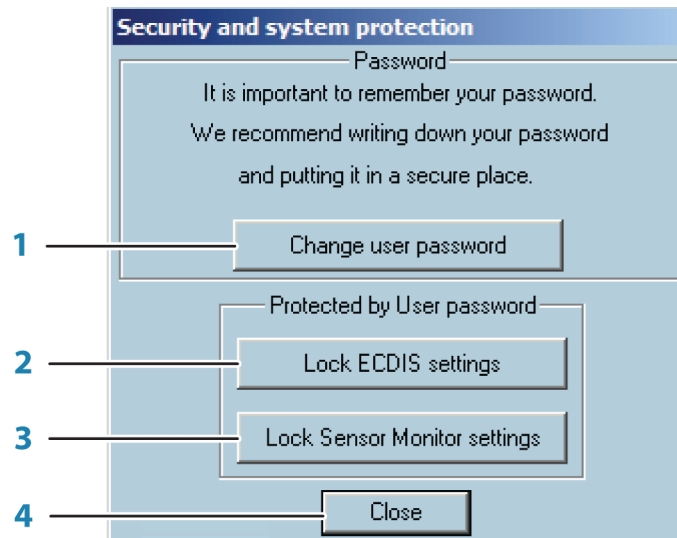

1 Change user password button

Click once to display the **Change password** input dialog

2 Lock/Unlock ECDIS settings button

Click to lock/unlock the ECDIS settings. When the ECDIS settings are locked, users cannot modify the following:

- Ship parameters
- GPS and radar antenna positions
- Alarm settings
- Ship display parameters
- Safety settings (safety contour, safety depth, safety height, deep contour)
- Console options

To unlock and modify the ECDIS settings, enter the correct password and click OK.

3 Lock Sensor Monitor settings button

Click to lock/unlock the Sensor monitor settings. When the Sensor monitor settings are locked, users cannot add new sensors and modify the settings.

To unlock the Sensor monitor settings, enter the correct password and click OK.

4 Close button

Click to close the **Security and system protection** dialog

→ **Note:** There is no default password after the ECDIS900 has been installed. It is strongly recommended that after the ECDIS is configured, passwords should be added and the ability to change configuration settings should be tightly controlled. This will help ensure the operational reliability and security of the ECDIS and supporting systems.

To reset your password, contact NAVICO at **CMD.Service@navico.com**.



ECDIS settings option

From the toolbar panel, click the **Options** button to open the **ECDIS settings option** dialog.

This enables mariners to manage the following:

- Customize the console layout
- Adjust the ECDIS local time and chart time
- Select the route parameters by default
- Create back up and restore user data
- Customize the display and settings

→ **Note:** The **Console** tab is not visible if ECDIS settings are locked.

Configuring console options

The data acquired from the sensors that are connected to the ECDIS system is displayed in the console area. The layout of the console area can be adjusted according to the available sensors and the selected tools according to OOW preferences and task at hand.

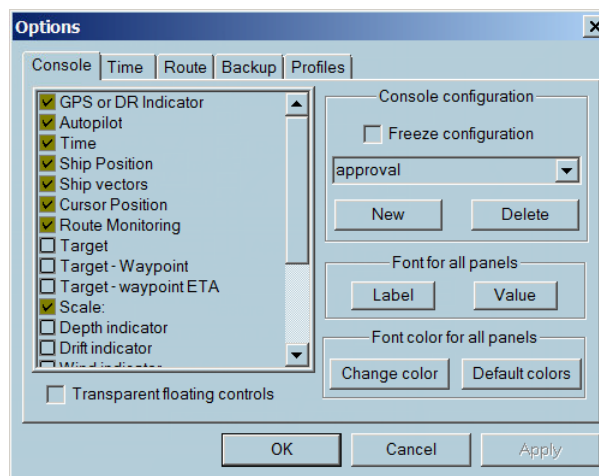

It is possible to predefine several configurations of the console layout in order to use an appropriate layout according to the current type of work. For example, a configuration can be defined for route monitoring displaying only active waypoint, drift and target information. Another configuration can also be defined for docking including Ship's parameters, drift and the cursor position.

→ **Note:** The settings are password protected. To unlock, refer to "*Security and system settings*" on page 26.

Creating a configuration

The **Default** and **Approval** configurations are installed by default.

To create a new configuration, follow the steps below:

1. Click the **New** button.
2. Enter a desired name.
3. From the list, select the different panels you want to be displayed in the Console area.
4. Adjust the size, type and font colors.
5. Click the **OK** button to save.
 - To move the panel, drag and drop the panel to a desired location in the screen.

→ **Note:** If the panel is dragged outside of the console area it is displayed as a floating window.

Transparency floating control option

Select the option to display the panel with transparency on the chart.

Lock a configuration

It is recommended to lock the editing once the configuration is properly defined to avoid unwanted changes.

To lock, tick the **Freeze configuration** checkbox.

Loading a configuration

The **Console configuration options** dialog enables mariners to choose an existing configuration to be defined in the system.

Select from the drop down list and click the **Apply** button.

Configuring ECDIS time settings

The ECDIS900 system operates using local time. Local time is calculated from UTC time and time zone information.

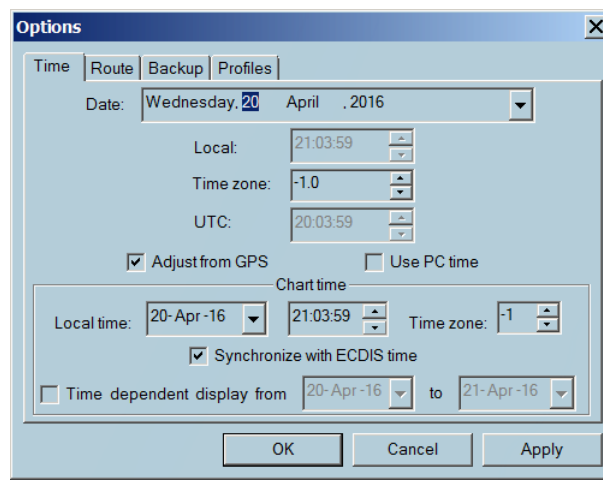

The UTC time is adjusted from GPS by default.

Tick the **Adjust from GPS** checkbox to set the time based on the GPS data.

Tick off the **Use PC time** checkbox to manually set the UTC date and time.

Tick on the **Use PC time** checkbox to use the PC date and time.

→ **Note:** The time zone is by default displayed with the plus + sign in Western hemisphere and the minus - sign for the Eastern hemisphere.

The **Chart time area** contains time and date parameters for the charts. By default, the parameters are synchronized with the ECDIS time. When the synchronization is off, the warning symbol is displayed on the Legend panel.

To display time dependent objects, tick the **Time dependent display** checkbox and set the required dates.

Configuring a back up data

To save a backup data, select the type of data by ticking on/off the checkbox and click the **Save** button.

Data can be saved in the hard disk or in any computer connected in the LAN.

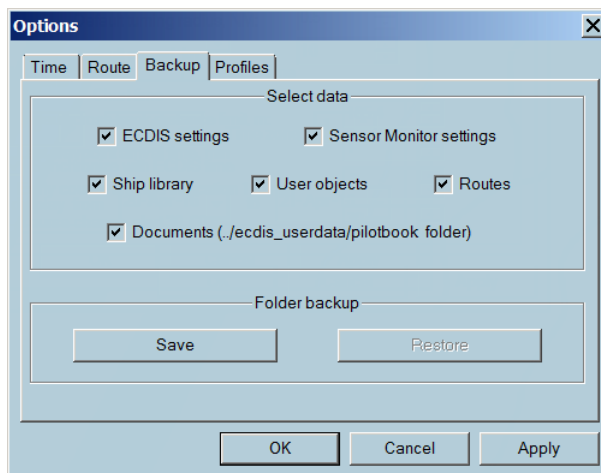

Restoring data

Click the **Restore** button and select the back up folder to restore all data.

Warning: The restored data replaces the current data used by ECDIS and data created after the back up will be lost.

Creating profiles

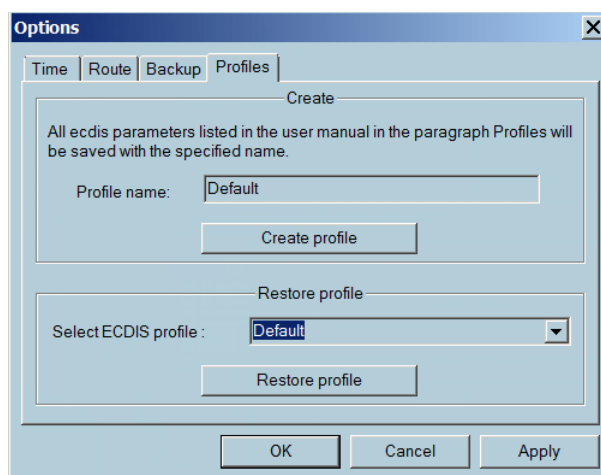

You can save custom ECDIS parameters configuration as a specified profile.

Once the configuration has been defined, set the profile name, and click the **Create profile** button.

To use one of the saved profiles, select the profile from the drop-down list, and click the **Restore profile** button.

Refer to "*Profile configuration parameters*" on page 200 for list of parameters.

6

Tools for safe navigation

Man over board (MOB)

This enables users to keep an **MOB** waypoint record of the exact location that someone went overboard and send AIS warnings to other vessels. The AIS warning alerts nearby vessels to request assistance in the rescue operation or simply to stay clear as the situation requires.



→ **Note:** This function is only available on the Monitoring workstation.

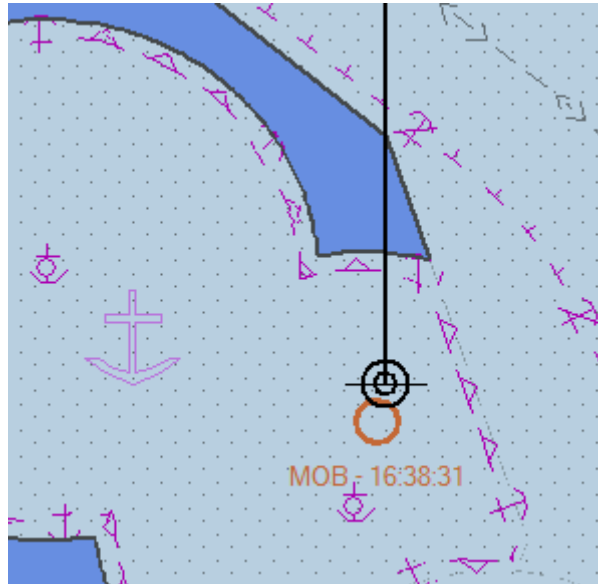

The MOB waypoint

A new log entry is stored in the logbook with the **MOB** position and navigation parameters.

→ **Note:** To delete an **MOB**, select the **MOB** waypoint, right click and select **Delete** on the pop-up menu.

To view and manage the properties of a waypoint, right click the selected waypoint and click **Properties** from the pop-up menu.

Time (UTC)	LAT	LON	Event type	Comment	COG	SOG	HDG	S
00:16:03	51 49.871N	004 04.935E	-	Man over board - ...	-	-	-	-
00:00:19	51 49.871N	004 04.935E	Ship watch	Cell: MS2W1303.0...	0.00	0.0	0.00	0
00:00:49	51 49.871N	004 04.935E	Ship watch	Cell: MS2W1303.0...	0.00	0.0	0.00	0

→ **Note:** AIS SRM message is sent after confirmation.

Adding an event

To plot a new point on the chart at the ships location, click the **Event** icon and enter comments in the dialog.

Click the **OK** button to save the event information.

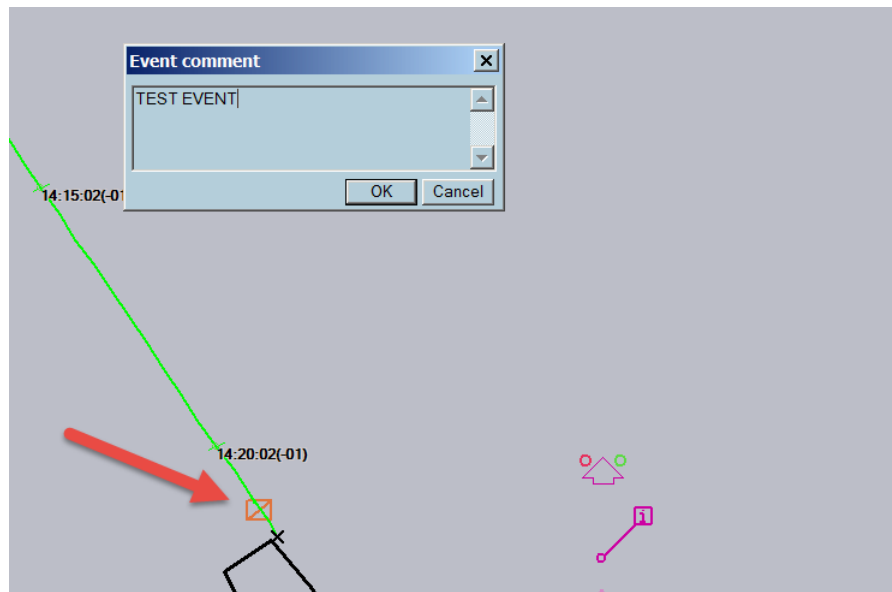

The event information displays the time of the event (UTC), course over ground to the next waypoint (COG), speed over ground (SOG), and user comments.

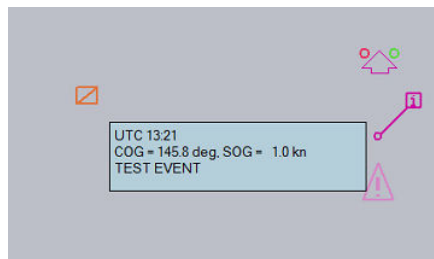

Selecting chart area

To view the predefined scale of your chart area, click the **Select area** icon from the toolbar panel.



A chart area is defined by:

- Name
- LAT (latitude)
- LON (longitude)
- Scale

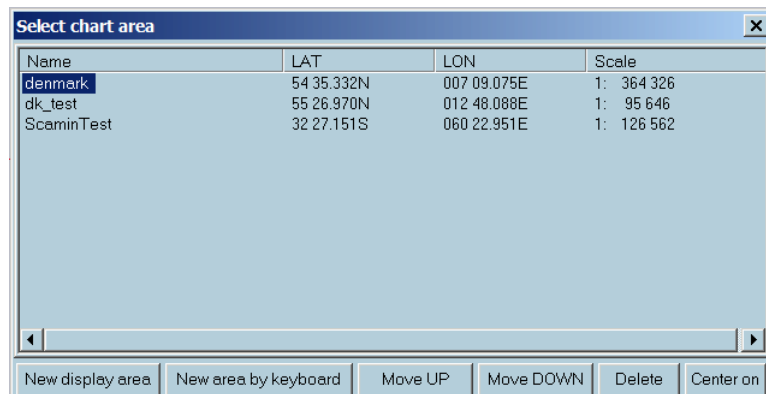

Creating new display area

To create or record the current position of the chart area, click the **New display area** button and input the desired name of the newly added chart area.

Creating a new display area manually

To create a position of a chart area manually, click the **New area by keyboard** button and input the desired name, LAT, LON and scale. Click the **OK** button to save the changes.

→ **Note:** To switch the current chart area to a new chart area, double click the chart name or select the chart name and click the **Center on** button.

Creating a new display area

To set a new display area of the charts, follow the steps below:

1. Move the chart to the desired position and select a preferred scale.
2. Click the **Select area** icon once to display the **Select chart area** dialog.
3. Click the **New display area** button once. An **Unknown** chart name is automatically created with the geographical center and scale.
4. Change the auto populated chart name to desired chart name.
5. Close the window.

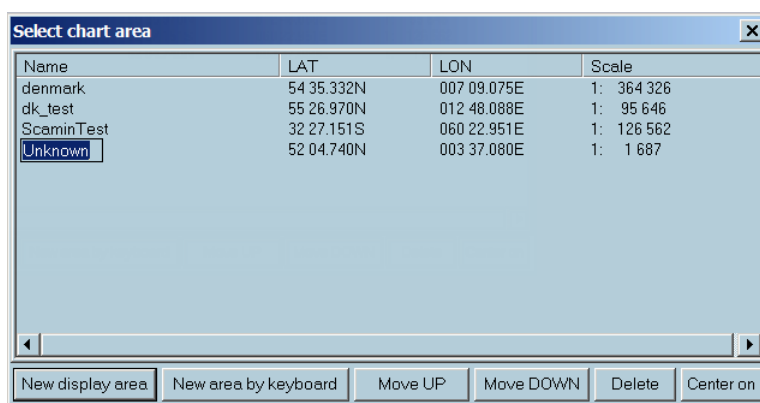

Creating new area by keyboard

To set a new chart area using keyboard, follow the steps below:

1. Click the **New area by keyboard** button once to display the **Display area parameters** dialog.
2. Enter the name, the latitude and longitude of the point center of the screen, and the scale.
3. Click the **OK** button to save the newly created display preferences or **Cancel** button to exit or discard the changes.

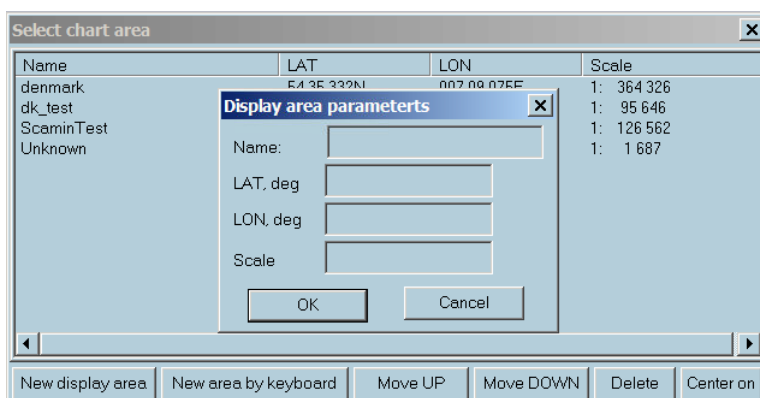

Deleting the chart area

To delete a chart area, follow the steps below:

1. Click the **Select area** icon once to display the **Select chart area** dialog.
2. Select the name of the chart area to be deleted.
3. Click **Delete** button to delete the selected area.

- **Note:** A list of chart areas is created for every specific type of chart. The list created for ENC chart is valid only for this type and cannot be used with ARCS charts and vice versa.

Center on ship

To center the chart on the ship, click on the **Center on ship** icon. The chart will automatically be centered on the ship.



- **Note:** Center on ship is a one-time action.

To enable automatic chart scrolling according to the ship's movements, right click anywhere on the chart and select **Follow the ship** from the list.

- **Note:** You can also press **F3** key to center the chart on the ship's position and activate the **Follow the ship** function.

Auto centering

Click on the **Auto centering** icon to define a **centering zone**.

When the **Follow ship** option is enabled, the chart will adjust accordingly and following to the ship's motion when it is out of the centering zone.

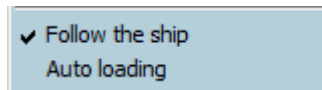

Centering zone can be a static or dynamic centering zones. The current type depends on the ship's heading.

Static centering zone

The **Autocentering** function defines the centering zone according to the ship's heading.

For example, when a ship is heading north, you define a rectangle located at the bottom of the window in order to display a chart area as large as possible in front of the ship. This zone is defined by default as a rectangle located in the middle of the screen.

Dynamic centering zone

Using a dynamic centering zone guaranties that you always have the largest chart displayed in front of the ship, even when the heading changes.

After the zone is defined, ECDIS900 dynamically sets the centering zone according to the heading.

For example, if the ship sails North East, ECDIS900 moves the centering zone to the bottom left of the screen and if the ship changes course to South, the zone is moved to the center top of the screen.

Click the **Auto centering** button to display the current centering rectangle.

The Autocentering can be defined as follows:

- Two red dotted line rectangles are drawn on the chart: the current centering zone (the smaller rectangle) and the rectangle defining the limits of the dynamic zones.
- To leave the centering rectangle unchanged and to delete it, click on the **Auto centering** button again.
- To define a new centering rectangle, locate the cursor at one corner of the desired zone then hold and drag to draw the appropriate zone.
- If a new rectangle meets the rectangle that defines the limits of dynamic zones, a dynamic centering zone is defined.

- **Note:** After the new rectangle is defined, the Auto centering function is off. Click the Auto centering button again to enable.

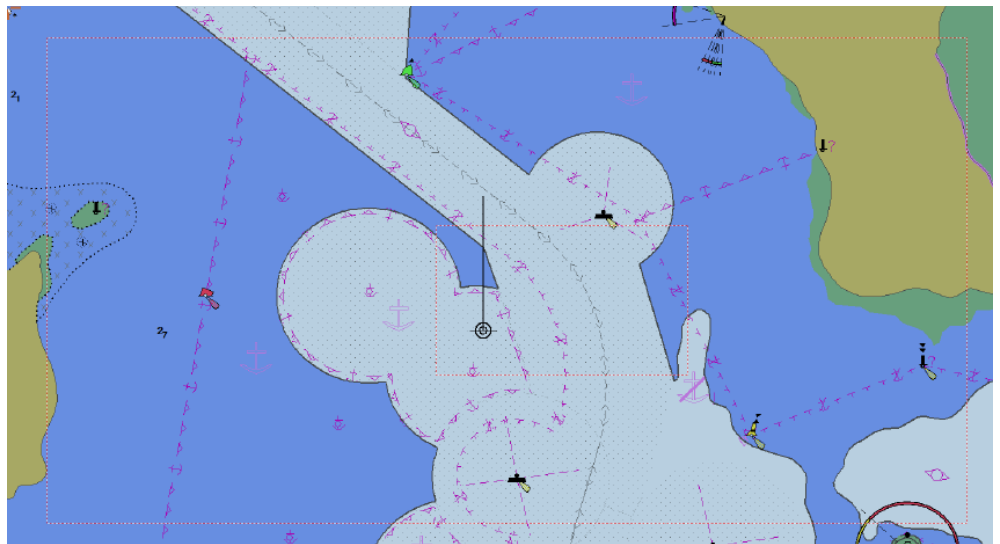

Targets

Setting a target

To plot a manual target, click on the **Set target** icon.

For more details about manual targets, see "*Manual target*" on page 128.



Target list

To display the target list, click on **Target list** button.

- Double-click on the target name to center the chart on the target.
- Click on the title to sort out the targets.



ECDIS900 acquires target via serial line from AIS transponder and ARPA radar connected to the system or using MARIS radar interface kit. Refer to "*Target display*" on page 127 for more details.

Show and hide targets

Click the **Hide target** button to hide the targets. All targets are hidden except the target on CPA/TCPA alarms which are displayed anyway.

You can also use the **F5** shortcut key to show and hide targets.

Relative vector

Click the **Draw relative vector** button to display the targets with relative vector. A relative vector is displayed in dotted line to distinguish from an absolute vector.

True vectors are displayed in solid lines.

Press the **V** key to switch between True vector to Relative vector.

AIS message, start and stop AIS server

The system allows sending and receiving short messages to/from another AIS. Click the **AIS messages...** button to display the **AIS messaging** dialog.

Customize table

Click **Customize table** to display the **Customize target table** dialog and select the items you want to display.

Target prediction

1. To predict the position of the ship and any ARPA targets, click the **Target prediction** icon.
2. To display the ship and target positions according to their current course and speed, scroll the slider to the desired point of time (in minutes).



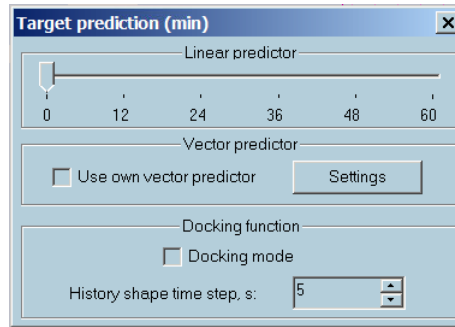

3. Tick the **Use own vector predictor** checkbox to calculate the future positions according to the current course and speed. The displayed positions on the screen are predicted.

Loading/Unloading objects

Routes and tracks are stored in the database.

Click the **Load/Unload objects** button to load/unload routes or tracks.



- **Note: Load** displays routes or tracks on the chart.
- **Note: Unload** erases routes or tracks from the chart.

Ship to point, range and bearing

1. To set a point at a fixed range and bearing from the ship, click the **Ship to point, range and bearing** button.



The cursor will appear as a cross with a circle attached to it. The actual range and bearing data is also displayed and measured from the conning position defined in ship parameter.

2. Move the cursor to the desired position (range and bearing) and click to fix the point.

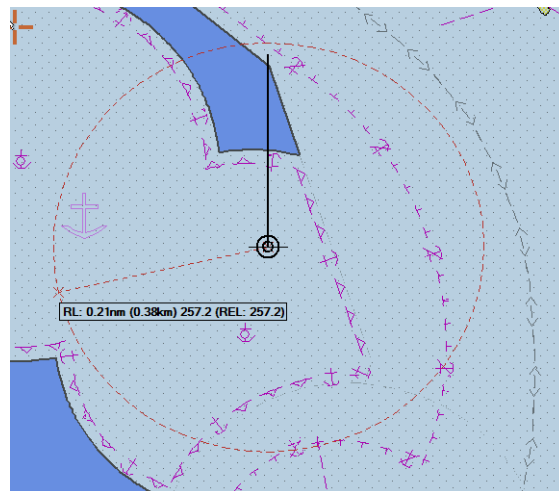

- **Note:** Use the object menu for removing a single VRM/EBL. To remove all VRM/EBL, use the **Delete** key from the keyboard or the **Clean chart** function from the chart menu.

Point to point, range and bearing

1. To set two points at a fixed range and bearing from each other, click the **Point to point, range and bearing** button.
2. The cursor appears as a cross. Move it to the first desired position and click to fix the point. When the cursor is in motion, it has a circle attached to it and the actual range and bearing data, measured from the first point is also displayed.
3. Move the cursor to the desired second position (range and bearing) and click to fix the second point.



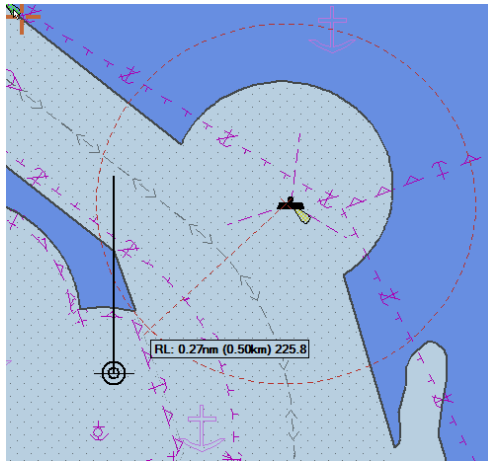

→ **Note:** Use the Object menu for removing a single EBL/VRM. To remove all EBL/VRM, press the **Delete** key from the keyboard or select the **Clean chart** function from the chart menu.

Ship to anchoring point, range and bearing

1. Right click the **Ship to point, range and bearing** icon and plot an anchoring point on the chart.



The information window displays the range and bearing from the bow of the ship to the anchoring point and the ETA.

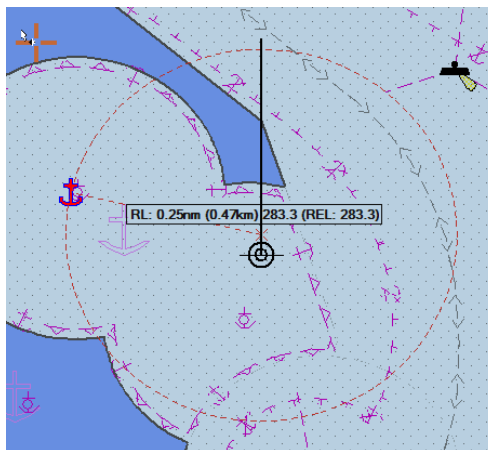

2. The position of the VRM/EBL popup window is user adjustable. Left click and drag to reposition the prompt window.

Modifying the ship properties

Click the **Ship properties** icon from the toolbar to display the **Ship properties** dialog. This enables users to manage vessel information, settings and parameters.



Updating the vessel information

To modify the ship name, type and size, follow the steps below:

1. Click the **Ship properties** icon to display the **Ship properties** dialog.
2. Select the **General** tab and modify the vessel parameters accordingly.

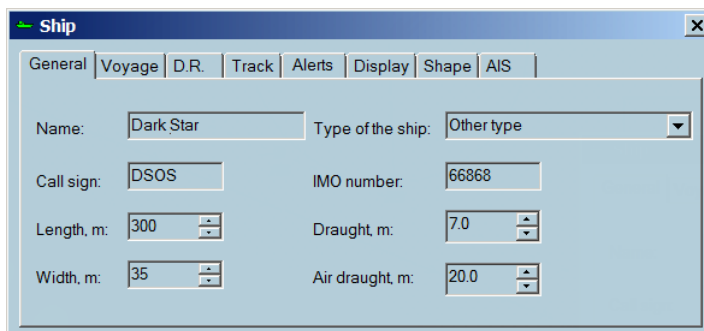

→ **Note:** **Call Sign** and **IMO number** are password protected and can only be modified if the correct password is entered.

→ **Note:** The ship parameters are transferred to AIS if ECDIS is interfaced to an AIS device.

Modifying the voyage information

1. In the **Navigation status** option, select your current navigation status from the drop down list. In the **Type of cargo** option, select the type of voyage from the drop-down list.

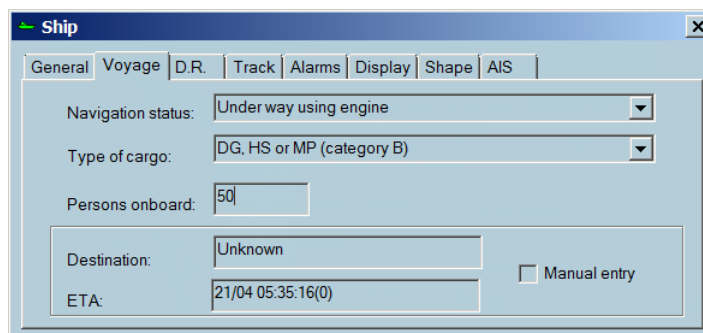

2. Enter the number of persons on board.

3. Tick on the **Manual entry** checkbox and fill in the **Destination** and **ETA** fields.

The cargo types meet the AIS specifications and are define as follows:

- DG: Dangerous Goods
- HS: Hazardous Substances
- MP: Marine Pollutants

There are four (4) levels of hazard:

- Level 1: Major hazard (**A**)
- Level 2: Hazard (**B**)
- Level 3: Minor hazard (**C**)
- Level 4: Recognizable hazard (**D**)

When **Manual entry** option is not selected, the Destination and ETA are automatically filled in when a route is activated. The destination is the destination entered in the Route properties and the ETA is continuously updated by ECDIS.

To send this information to AIS, open the Sensor Monitor, double click on the AIS Transponder item, and click the **More settings** button. Tick on the **Send data to the transponder** checkbox.

→ **Note:** The transfer to AIS transponder is available if the ECDIS is interfaced with an AIS transponder.

Enabling D.R.

1. Click the **D.R.** tab to to display the Dead Reckoning dialog.

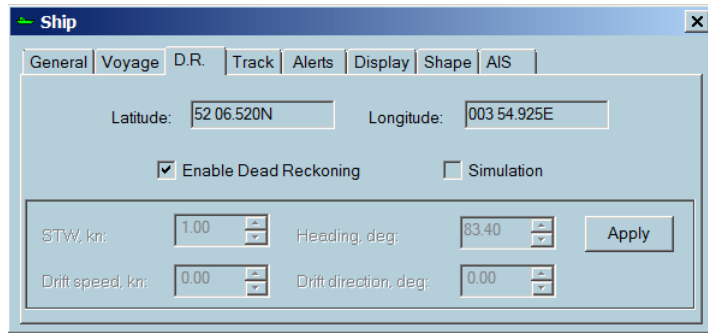

2. Tick on/off the **Enable Dead Reckoning** to enable/disable Dead Reckoning option. When the Dead Reckoning mode is enabled, a warning similar below is displayed:

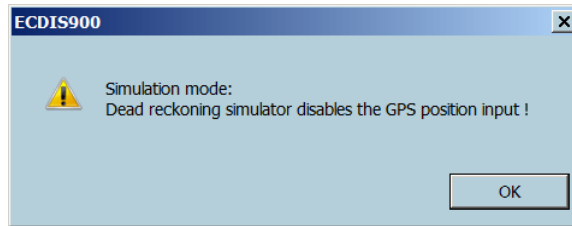

- **Note:** In the D.R. mode, the ship's position is calculated from the last position the system acquired from the GPS and from the current values of heading and speed. When the heading and speed values are no longer available, the D.R. mode will not be available and ECDIS switches to Simulation mode. When the D.R mode is active, the **Ship Position** values can be adjusted at any time on top of the page.

Simulation mode

The **Simulation** checkbox must be ticked on before heading and speed can be changed. Adjust the heading, STW, drift speed and the direction by entering new values using the keyboard or by clicking the arrow up/down. The values added are used to calculate the COG and SOG.

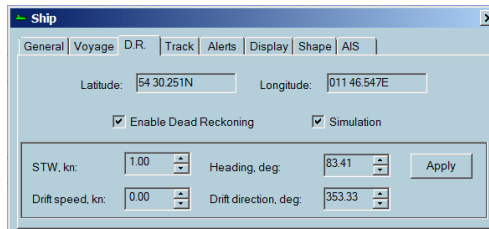

- **Note:** In simulation mode the ship icon is displayed with a red cross and the ship position is not displayed in the position panel.

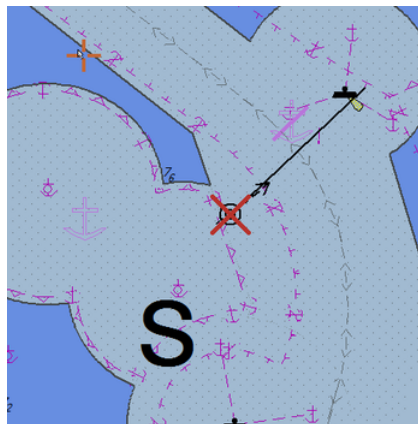

Managing track recordings

Click the **Track** tab to display the Track dialog.

Tick on/off the Show active track to show/hide the active tracks.

To set a desired number of recording days, use the arrows beside the Record ship track for the last option.

Use the arrow buttons to adjust the Recording Interval (in seconds).

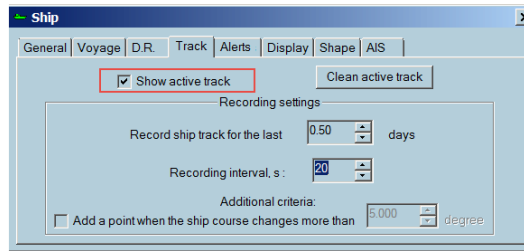

Additional criteria

Tick on the **Add a point when the ship's course changes more than** and enter a value (in degree angles) in order to control more efficiently the track recording as and when the course changes.

The image above displays that the ECDIS records one point every 15 seconds and a point each time the ship's course changes by more than 5 degrees.

→ **Note:** Selecting a small time interval will generate a huge track file containing lots of points that are time consuming to display. The above example is the recommended value to avoid creating huge files and without losing important ship track information.

Saving tracks

To save a selected track, right click on the track and select the **Properties** item from the list. Select the **Save** tab and enter the desired track name, date and time.

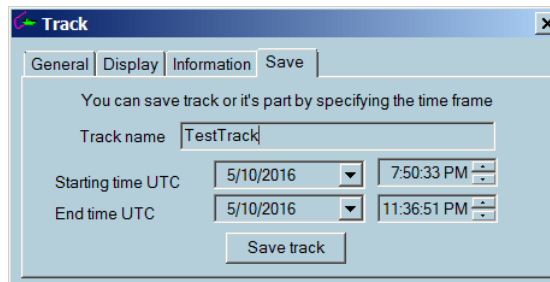

Click the **Save track** button to store the track in the database.

→ **Note:** The saved track can be downloaded anytime for reuse.

Load, unload and delete tracks

To load/unload routes or tracks, click the **Load/Unload objects** icon.

The list of tracks may be sorted in ascending or descending order according to the name or date.

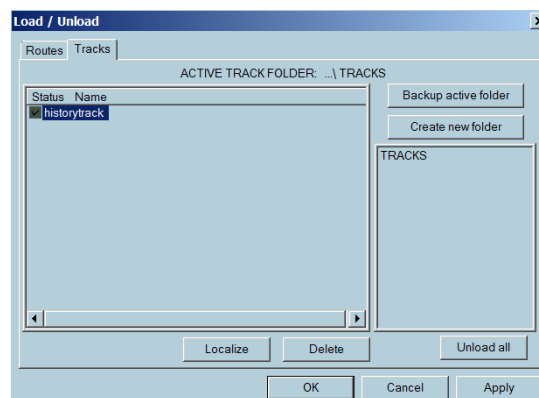

Use the **Create new folders** button to arrange and group tracks in specific folders.

A track can be copied from one folder to another.

Loading a track

To load a track, select the track name, tick on the check box and the **Apply** button.

To center the selected track on the chart, select the track name and click the **Localize** button.

→ **Note:** To load multiple tracks, tick on multiple checkboxes of the desired tracks and click the **OK** or **Apply** buttons.

Unloading tracks

To unload a track(s), select one or more tracks from the list displayed by either clicking on the name or in the check box and then click either **OK** or **Apply**.

→ **Note:** Unload can also be performed by clicking right on the actual track line and clicking Unload in the pop-up menu

Deleting tracks

To delete one or more tracks from the database, select the track name and click the **Delete** button.

→ **Note:** Unloading the current track is not possible. The current track must first be disabled from track recording before it can be unloaded.

Modifying track properties

To modify the track properties, right click the track and select **Properties** from the list. A dialog similar below is displayed:

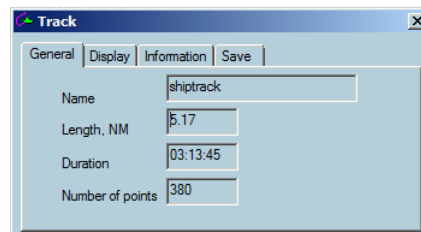

Modify the track name including the date and time the track was recorded and the number of points recorded along the track.

Duration is a time used to sail the length of the track.

Adjusting the track display colour

Use the **Day colour** or **Night colour** buttons to change the day/night track display colors.

You adjust the thickness of the track line by adding numbers in the **Tickness** field.

Tick on the **Draw time labels** to display time markers along the track. The markers are automatically adjusted according to the chart scale.

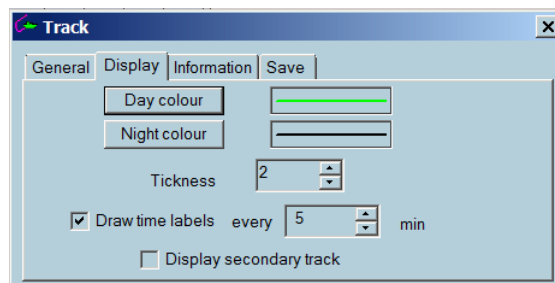

You can add a detailed description of the track in the **Information** tab.

Information tab also displays the ship's speed and course at the recorded point of the track which is the closest one from the clicked point.

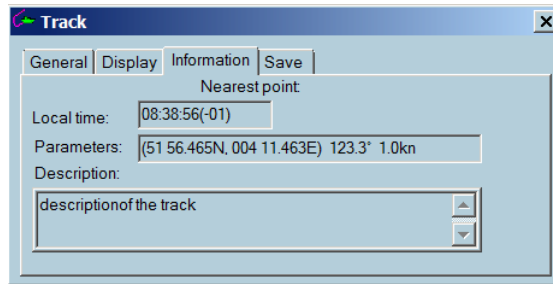

Creating routes from tracks

The ECDIS900 enables mariners to create a route from any track.

1. Select the track from which a route is to be created and select **Create route from track** from the pop-up menu.
2. Enter the recommended number similar below to minimize the number of waypoints and to have a minimum distance between two waypoints:

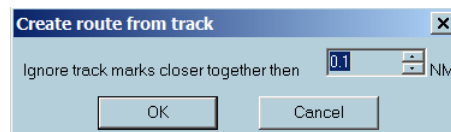

3. Click the **OK** button to save.

Configuring alerts

Click the **Alerts** tab to display the **Alerts** dialog.

The **Alerts** dialog enables mariners to control the activation of alarms for different events.

→ **Note:** The alert configurations are available for editing on the Monitoring station only.

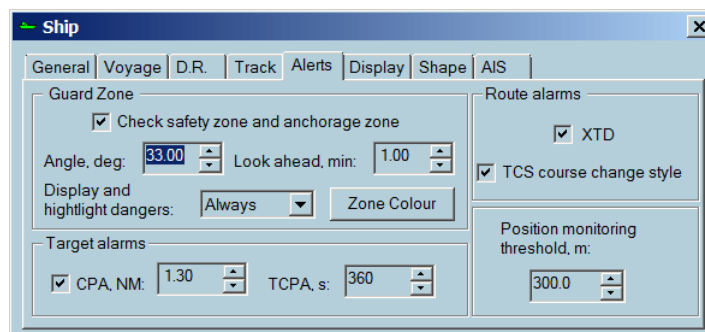

Guard zone

Tick on/off the **Check safety zone and anchorage zone** to activate/deactivate this function.

A safety zone can be set in front of the ship for automatic monitoring inside the defined zone and the vessel's crossing.

The zone is defined as a cone by an angle and a distance.

Set values for angle and distance to define the cone shape of the zone.

Dangers are highlighted by default and it is always highlighted when operating in the Planning workstation.

If danger highlighting is off, the warning icon is displayed on the Legend panel.



→ **Note:** Alarms are highlighted in red.

→ **Note:** Warnings are highlighted in yellow with black border.

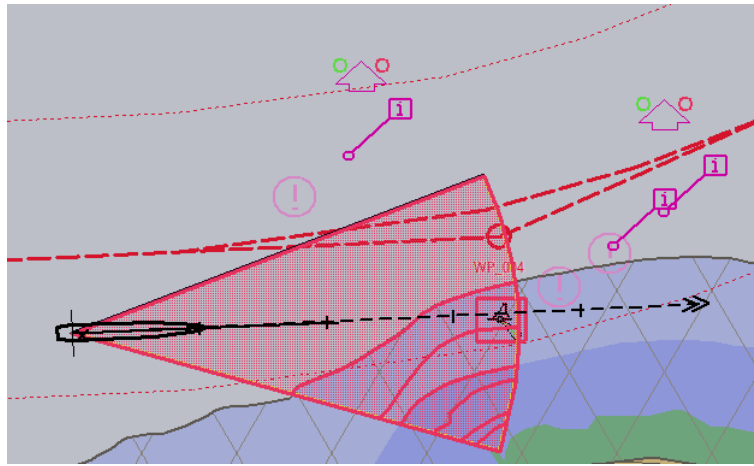

→ **Note:** All dangers in all chart layers are highlighted. If a danger is not on the current visible layer, it is highlighted when it is in the guard zone sector.

Click inside a ship guard zone to view the list of dangers and display the detailed overview of the alarm type.

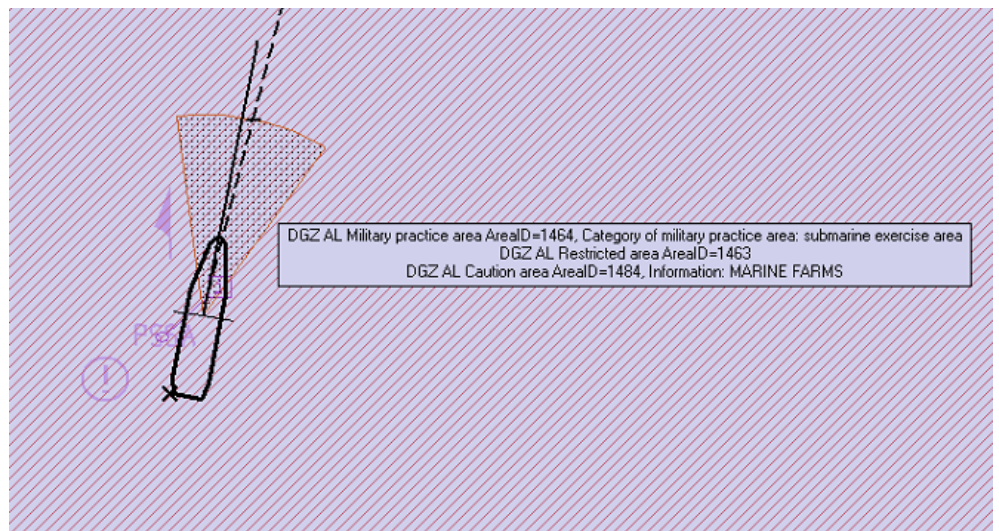

Other alarms

- CPA: Closest point of approach.
- TCPA: Time to closest time of approach.
- XTD: Cross Track Distance.
- TCS course changing style.

To enter the alarm criteria (e.g. XTD limits, the waypoint arrival limit, the first and second alarm time), refer to "*Route options*" on page 111.

Display tab

Color settings

You can define colors of the ship symbol and shape plot.

1. To set the color, click the **Day color** button. The color dialog appears

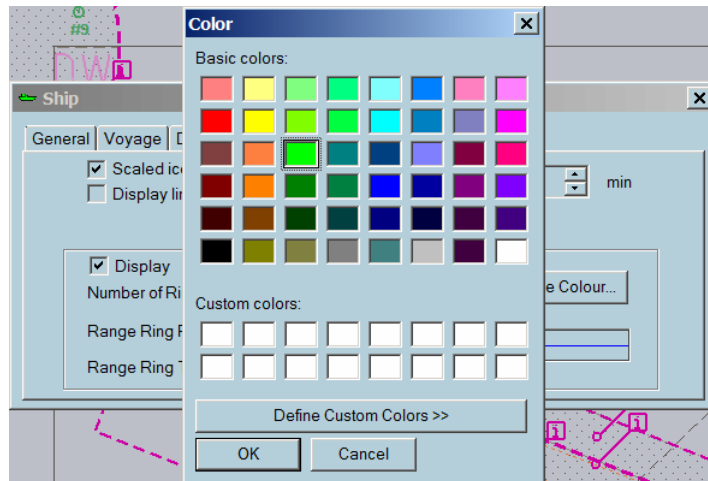

2. Select the desired color and click OK to save the changes on the ship symbol color and shape plot color.

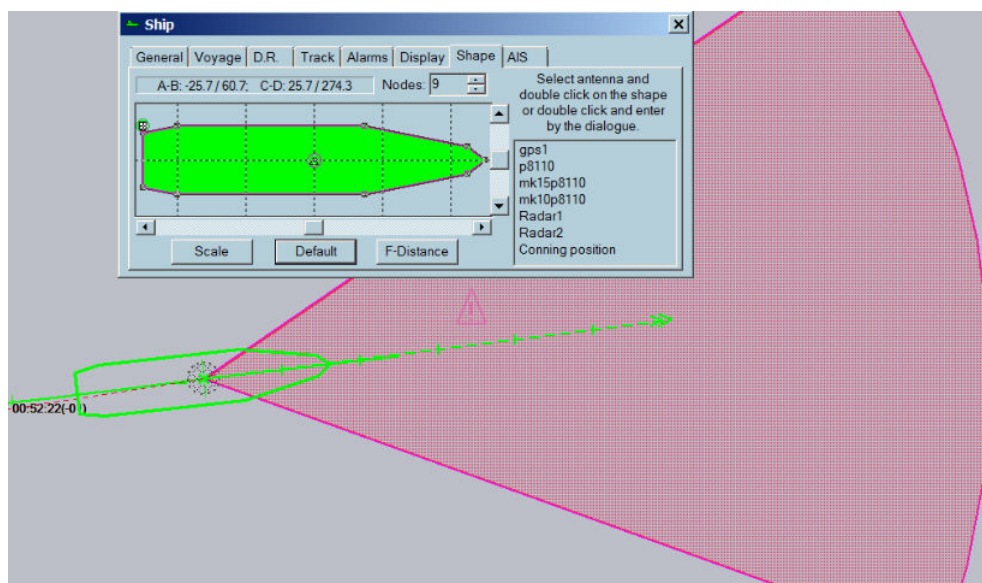

To change the night mode colors, click the **Night color** button and modify the colors.

→ **Note:** The changes on the color is only visible when the night mode is on.

Scaled icon

1. Tick on the **Scaled icon** check box to display the ship icon with its right scale.

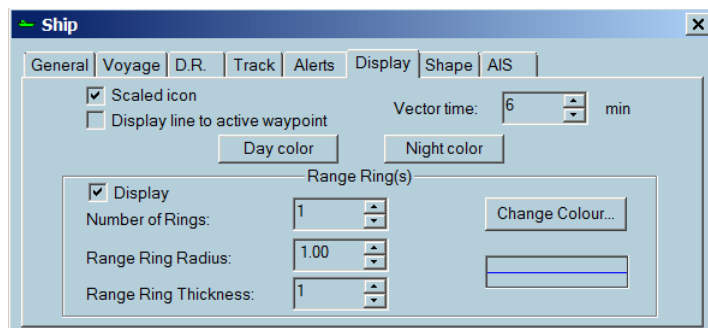

2. To **display a line to the active waypoint** tick on the proper check box.
3. Set the desired **Vector time** value. The length of both the ship's vector and the target's vector depends on the ship's speed and the vector time value.
4. Tick on **Display** to display Range circle(s) around the ship. Set values for:
 - Number of circles
 - Range circle radius
 - Range circle thickness
- 5.

→ **Note:** When operating in the **Service mode**, the ship display color can be modified.

Shape tab

GPS antenna position

Click on the **Shape** tab to bring the Shape page to the front.

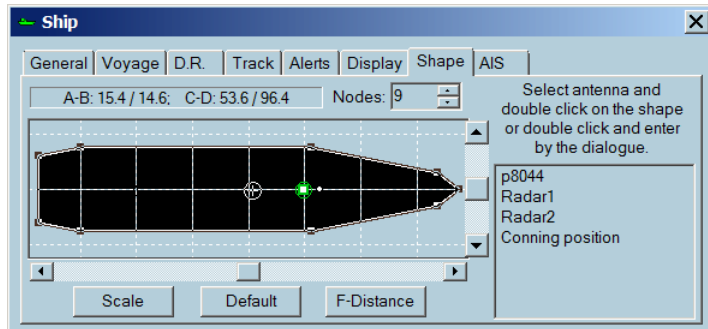

Set number of nodes manually.

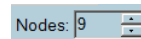

To change a node location, click on the node on the shape plot and drag it. The node coordinates will change.

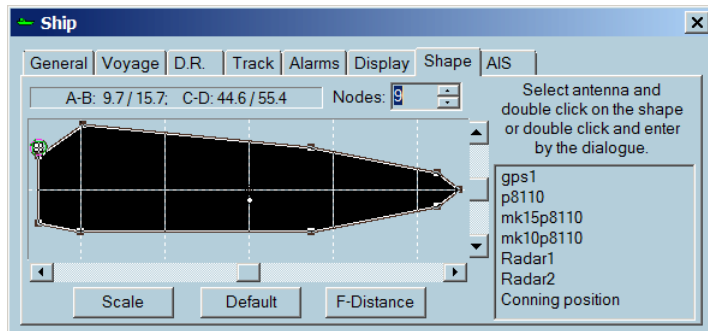

Click **Default** to set values to the default values.

Click **Scale** to reset the scale of the window to enable the ship to fit inside.

GPS antenna

The GPS antenna is displayed as a circle with a cross inside it.

There are two ways to change the antenna position:

- Double click on the antenna's name in the list. The position settings dialog appears

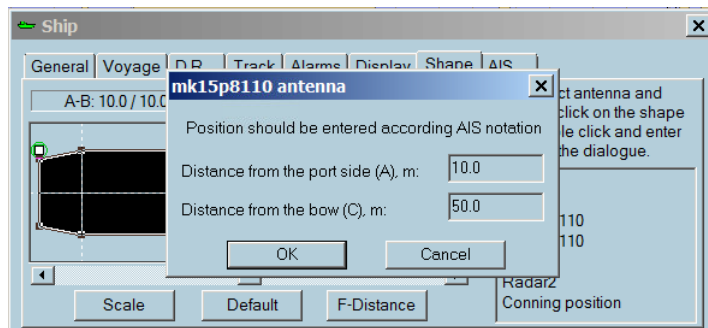

Set the position and click OK

- Click on the antenna's name in the list selecting it.

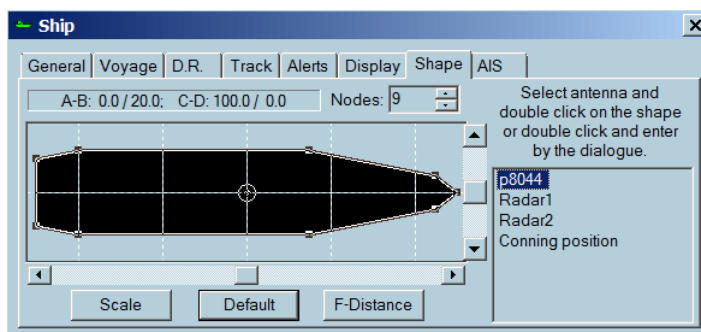

When the item is selected double click on the desired position within the shape plot . The antenna's symbol changes its position.

The position of the antenna can be monitored within the box located at top right-hand corner of the window.

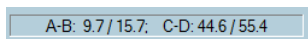

Where:

- **A** is the distance from the portside
- **B** is the distance from the starboard
- **C** is the distance from the bow
- **D** is the distance from the stern

Fixing a precise GPS antenna position is very important by reference to displaying the ship in her correct position, particularly when the chart is displayed with a precise scale and the ship at her correct scale.

→ **Note:** This operation is available in the Monitoring station mode only.

Radar antennas

Both the Radar antennas are displayed as a white square. Their positions are changed the same way as the GPS antenna's one.

The radar position affects the radar overlay display. To select the active antenna use the Radar tab on the console. See "*Radar*" on page 127.

Conning position

The conning position is used as the origin for VRM/EBL tool, the origin of the ship vectors, ship guard zone. The conning antenna's symbol is triangle. Its position changes the same way as the GPS antenna's one.

Turning

Click on the **F-Distance** button to enter the value of the distances the ship makes before turning.

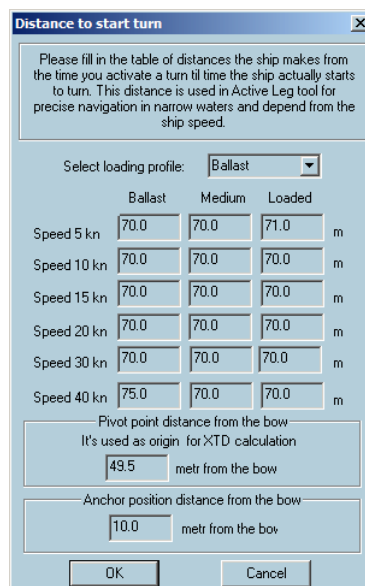

This table is used in the Predictor module to calculate the future position of the ship when it turns.

For more details see the chapter *"Predictor"* on page 183.

AIS tab

If AIS is connected to the ECDIS workstation, ECDIS900 receives from the transponder the own ship's parameters set up in the AIS transponder.

The information is displayed in the AIS panel and the green icon displayed in front of the parameter means that ECDIS900 setting is the same than AIS setting for the selected parameter. If the icon is red the parameter in AIS is different from the parameter in ECDIS900.

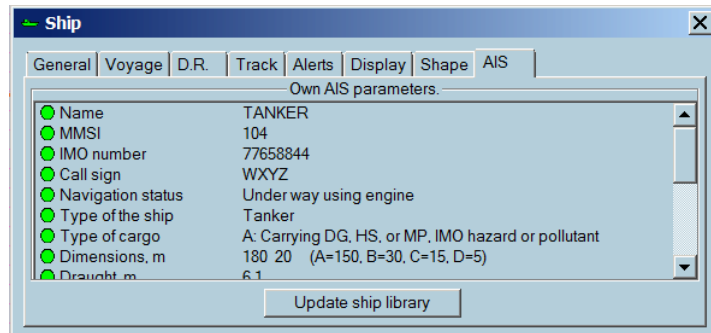

If any discrepancy occurs, ECDIS900 proposes to synchronize the data by using in ECDIS900 the data setup in AIS.

Show port list

To display the port icons on top of the chart, click on the **Port database** icon.



Access to the port information is possible only if the user has subscribed to Fairplay database.

Right click on the port icon to access to all information stored in Fairplay database.

Tide and current information

Click the button **Show/Hide tide stations and ocean current** and icons showing the tide level are displayed at the tide stations locations. There are more than 2000 main tide stations are available in ECDIS900.



→ **Note:** The icons are visible when the chart scale is bigger than 1/2 000 000.

Select the tide type by right clicking on the **Tide** button when it is activated.

Below are the different modes:

- ECDIS mode (optional)
- Total tide (UKHO)

Tide

ECDIS Tide



→ **Note:** Right double click the **Tide** button to display a window listing the tide stations available on the chart. Click to highlight the tide station and double click to open the station properties dialog

The small tide icon displays in red the tide level at the current chart time and small black oriented arrows indicate rising or falling tide. Right click on the icon for access to detailed description of the tide but also to the moon and sun rise and set hours for the selected station.

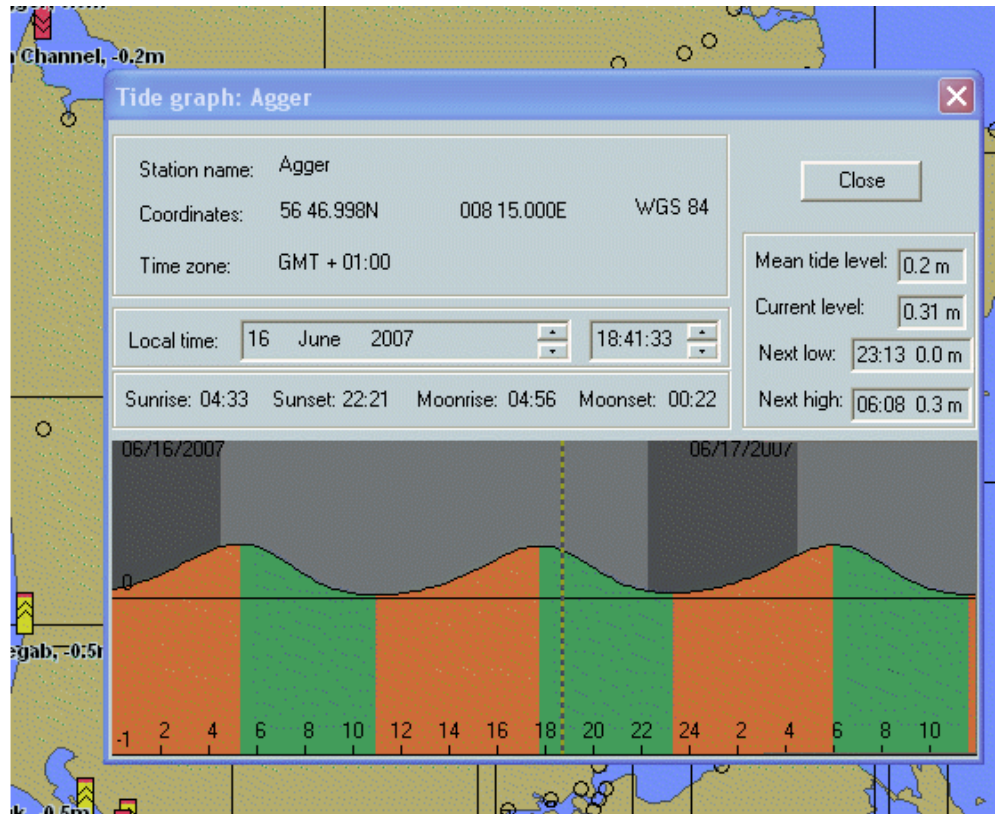

Tide date

The tide is calculated for the current ECDIS time.

Ocean current

The date is displayed on top of the chart when a weather forecast file is loaded. For more details about weather forecast see "*Weather forecast*" on page 48.

The chart date could be different from the ECDIS time displayed in the Time panel: indeed when weather forecasts are displayed on top of the chart it could be useful to select another chart date to display the future weather situation.

The chart date is displayed in local time. It can be adjusted in the time setting dialog or synchronize with ECDIS time using the button **Time synchronization** located in the weather panel.

Total tide

This module should be installed and requires license key and activation key.

Different kinds of ports are defined:

Standard ports - These are ports where the tidal predictions are calculated from a set of harmonic constants.

Secondary ports – same as Standard port, however the observations made to collect this information generally were not as extensive as with standard ports and so the tidal predictions are of average quality.

Secondary ports (non-harmonic) - These ports do not have any harmonic constants, instead their tidal predictions are calculated by taking the prediction for a reference port and applying time and height differences.

Main tide stations are represented by a red square icon, and secondary stations by a yellow one. In this case, click the proper link to open the main station window.

U Custom ports - These ports are ones that are defined by the user by manual input of a set of harmonic constants.

The chart date is displayed in local time. It can be adjusted in the time setting dialog or synchronize with ECDIS time using the button Time synchronization located in the weather panel.

Select the different view.

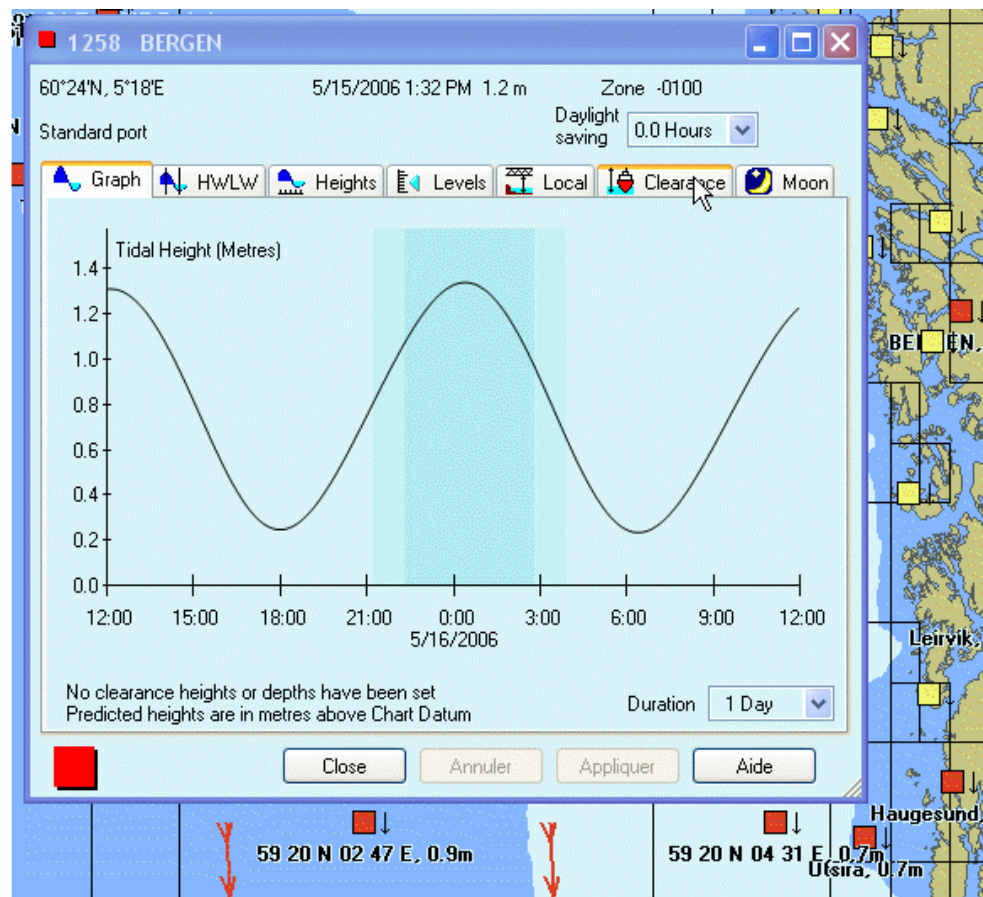

Weather

To access the weather module, click the **Weather** button in the toolbar or select the **Weather** tab on the console.

Weather module displays different weather layers including wind force and direction, pressure, swell, waves, typhoon history and forecasts, and temperature.

Weather forecasts may cover several days depending on the source of the data.

For a detailed overview of the weather module, see "*Weather forecast*" on page 48.

Weather forecast

General

The Weather module is for displaying weather forecasts overlaying navigation charts. The data can be ordered with MBA (see MBA User manual). Also you can find the Weather service management on the www.chartservice.maris.no.

The following file formats are supported:

- grib&grib2 for waves, current, temperature, wind force and direction, pressure, swell, etc.
- additional data typhoon&ice (proprietary formats of providers)

→ **Note:** Local area forecasts are 5-7 days only. The 9 days forecasts are for ocean areas.

→ **Note:** NAVICO disclaims responsibility for grib&grib2 files supplied by the providers which are not in the recommended list if these data is not displayed correctly.

A weather file includes several layers with data of defined period. For instance 5 days forecasts for wind and pressure situations, with weather data every 12 hours.

The ECDIS interpolates the data in time and position making possible to display continuously over a period of time and a geographical area all data included in the file.

Recommended weather providers

- Sat Ocean
- Meteo Consult

- SMHI
- Epson Meteo

Weather tab

From the Console area, click the **Weather** button to display the Weather dialog.

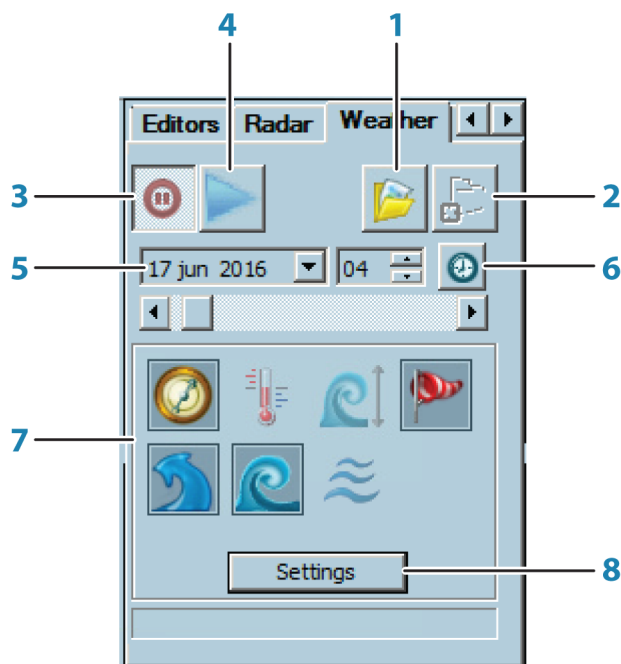

- 1 Load file** button
Click to display the **Select GRIB file and loading mode** dialog
- 2 Unload file** button
Click to unload the loaded weather file
- 3 Autoloading** button
Click to automatically select the files with current data to load.
- 4 Play/Stop animation** button
Click to replay the downloaded forecast in Fast play mode
- 5 Date and hour**
Use this field to select a specific date and hour of the forecast
- 6 Current date**
Use this field to set the current date and hour
→ **Note:** In case of historical data, the slider jumps to the end of the period
- 7 Layers** button
Click to enable and display the layers.
- 8 Settings** button
Click to display the **Settings** dialog.

Weather files management dialog

All weather files are stored in the subfolder called Weather in the folder ECDIS_Userdata and are automatically listed in the file management window.

When a file is selected the content of the file is described in the right File preview panel, with the different parameters recorded in the file.

The toolbar gives fast access to the main file management functions (refresh folders content, create/delete folder, delete, copy&paste files).

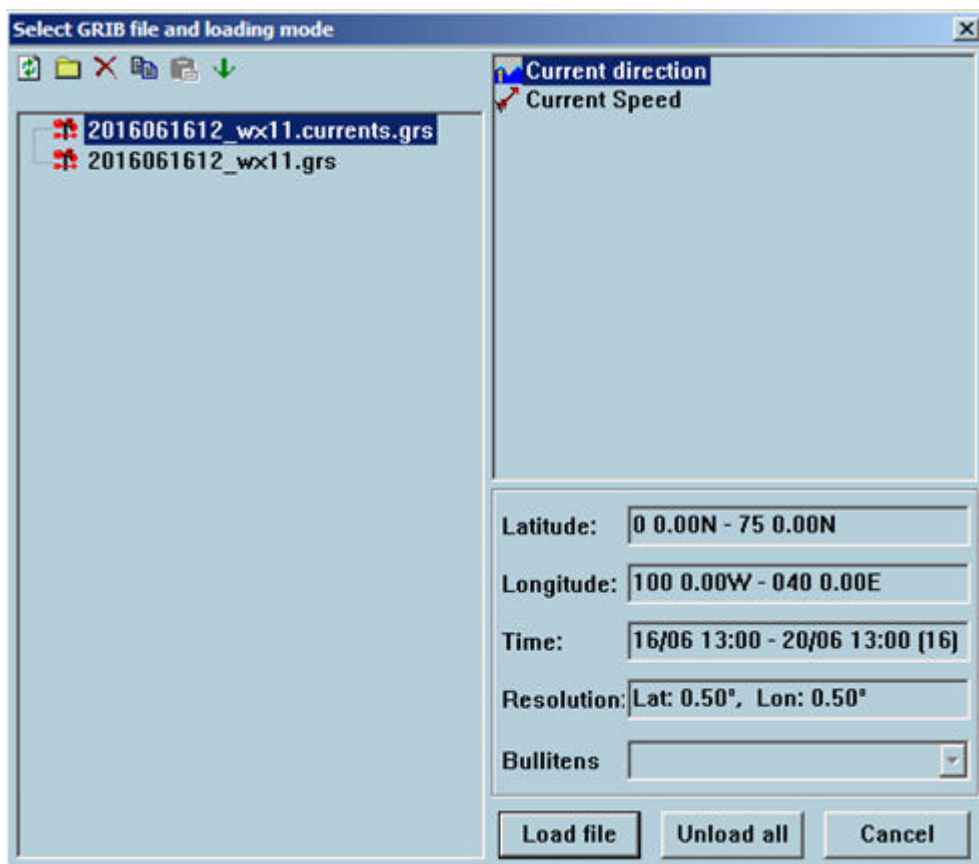

Weather layers

The following layers can be available:



current



temperature



pressure



visibility



waves



ice



wind



typhoon



swell

Use the settings dialog to define colors and other layer parameters.

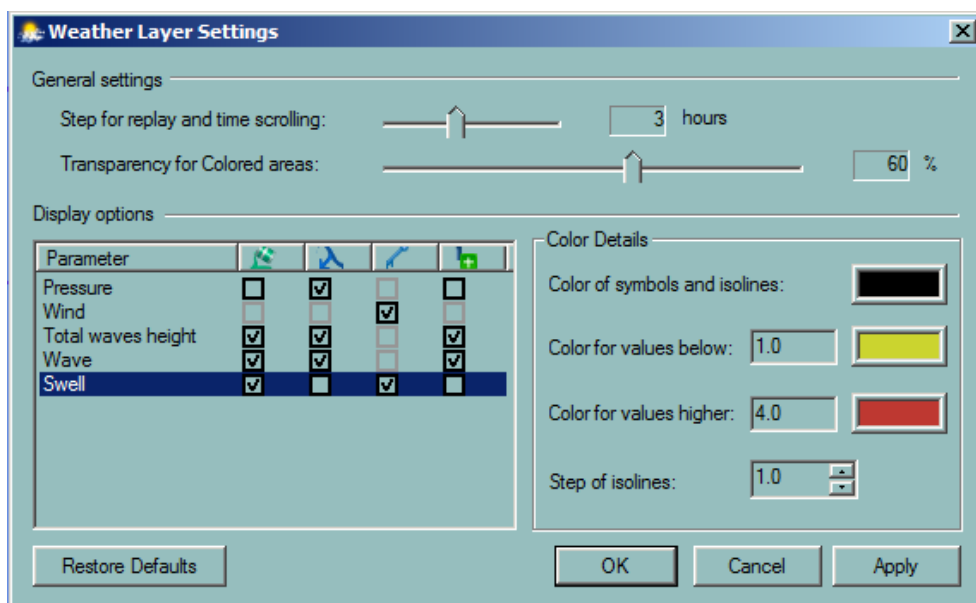

Layers illustration

It is possible to display one or more forecast layers. Each layer has four parameters to display that can be switched on or off:

- Fill
- Isoline
- Direction
- Text info

→ **Note:** No more than one layer can be filled in. Some layers have the direction parameter unavailable

Example

The wind display with all parameters switched on looks like that.

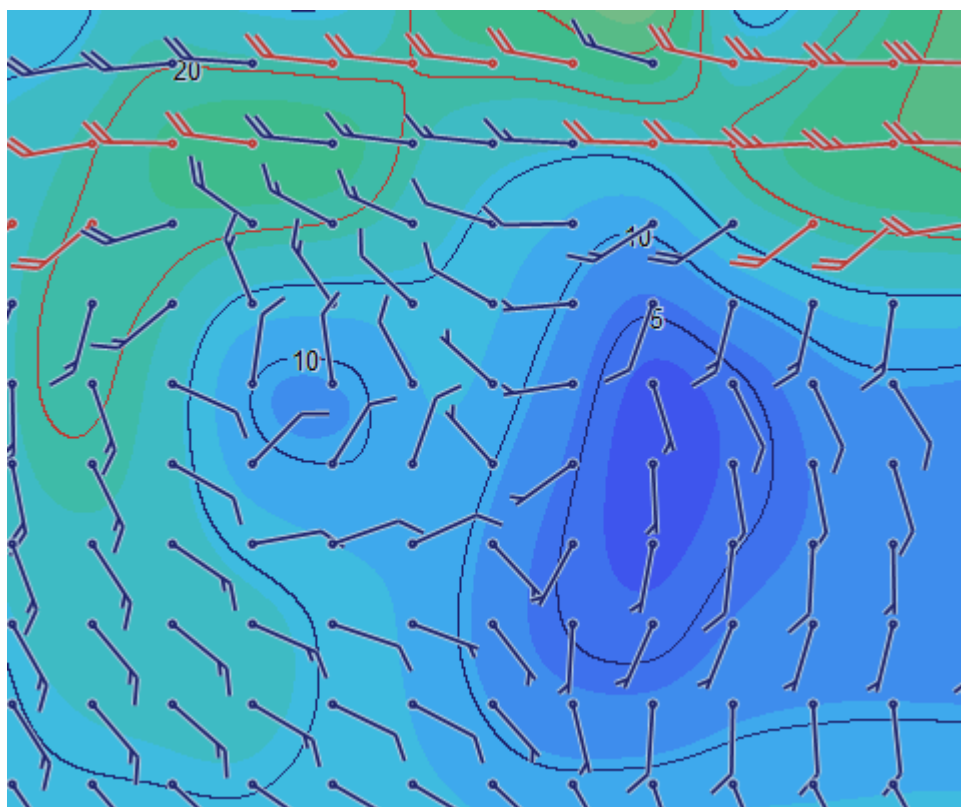

→ **Note:** To see the entire text information put the cursor on the selected location and wait about several seconds. The tip with information appears.

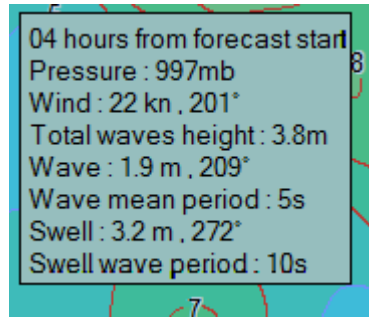

NYK Guard Zone settings

The NYK group has established an NYK standards values for safer navigation using ECDIS.

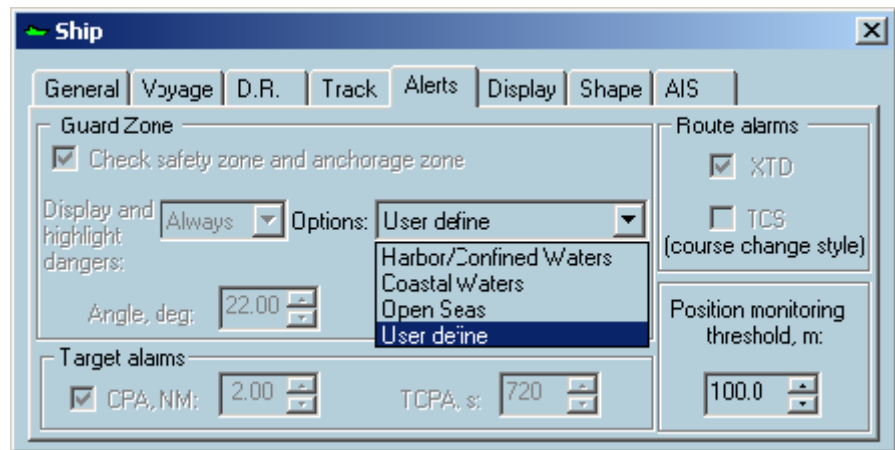

7

Ship profile management

This module is specially designed to suit the Pilot needs. The Pilot builds his own Ship's profile database and can select the proper profile when entering a ship.

A ship's profile contains all ship's and safety parameters settings including:

- Ship's name, call sign, length, width, draught etc.
- Position of GPS and Radar antennas
- Alarms settings
- Safety contour, depth, height...

Loading ship profile

Each profile is defined by the ship's name. To create a new profile manually, follow the steps below:

1. Right click the **Ship properties** icon to display the **Ship profiles** dialog.
2. Select the **Ship name** and click the **Load** button.

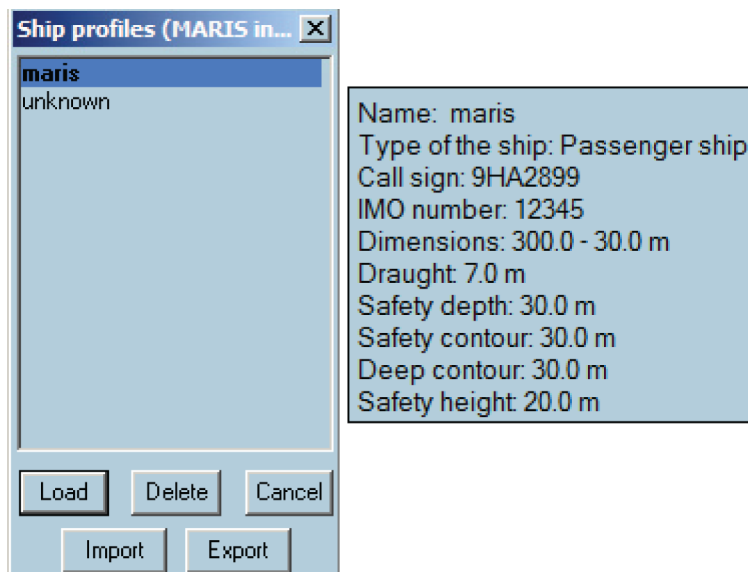

Editing ship profile

To edit the ship's profile, follow the steps below:

1. Open the Ships profile dialog and double click on the ship name or select the ship name and click the **Load** button.
2. Left click the **Ship properties** button to display the **Ship properties** dialog.
3. Modify the parameters accordingly.

Updating own ship data

It is possible to update the ship data in the ship library based on the own ship data received from the pilot plug of the AIS transponder.

When receiving own ship data for the first time after connecting to an AIS-transponder, the ECDIS900 checks if there are any discrepancies on the received data and the data (if there's any) of the same ship stored in the ship library.

If there are any discrepancies, or if the ship is not already present in the ship library, the ECDIS900 presents data and the discrepancies to the user, and ask whether the data in the ship library shall be updated.

The user has the option to select which data to be used, whether the existing data in the ship library, or data received by the AIS.

8

Charts

ECDIS900 system supports vector and raster charts. The ECDIS system runs automatically in RCDS mode when raster charts are used. (see "*RCDS mode*" on page 85).

Chart types

- ENC format are official Vector charts (see "*Electronic navigation charts (ENC)*" on page 54).
- ARCS are official Raster charts (see "*ARCS*" on page 84).

Brightness control

All system monitors are calibrated according to the standards. It is possible to change brightness manually, using the monitor buttons. When the brightness settings meet the calibration values, the monitor indicator is green, otherwise it is red.

Operational area

User operational area is between 85° S and 85°N. That means there is no possibility to perform operations with routes beyond this area (close to poles).

Chart database installation

To install chart database and catalogs, click on the **Chart handling** icon from the toolbar panel.

See "*Chart handling*" on page 67 for more details.



Electronic navigation charts (ENC)

Official vector charts produced by National Hydrographic Offices are called ENC, Electronic Navigation Charts and delivered in S-57 format.

S-57 is a public format used for data exchange and transfer but the charts in this format cannot be used directly in ECDIS.

There are several sources providing ENC data: Primar in Stavanger distributes ENC data for North European countries and France, UKHO for other European countries, Japan HO for Japanese areas, MPA for Singapore harbor etc.

NAVICO chart service includes several services to help the user including:

- Delivering charts from different sources
- Information on ENC availability
- Quotation and ordering facilities for specific areas or for charts along ship's routes
- Handling and sending updates from several sources.

ENC data from one source are delivered on 2 CDs:

- One base CD containing the charts issued at a certain data
- An update CD containing updates for the charts, new charts and new edition of charts.

ENC are in general encrypted and chart permits are required to be able to use them. The permits are ordered directly to NAVICO.

ECDIS operates ENC under a seamless mode and automatically loads new cells when scrolling or zooming all over the world.

When the chart area cannot be covered with ENC data for the selected navigational purpose, the remaining part of the chart area is filled with data based on a more navigational general purpose.

ECDIS900 is compliant with IEC61174 ed4 regarding ENC chart Installation and Update from:

- Single media using multiple exchange data sets
- Multiple exchange sets across multiple media sets.

→ **Note:** The chart information to be used in ECDIS should be the latest edition of information originated by the government HOs and conform to IHO standards.

Using ENC charts

ENC chart display is done according to official Presentation library (see "*Chart display*" on page 55). The following actions are available:

- Zoom and select other scales.

- Modify the content and the layout of the chart with the Chart settings dialog(see"*Chart settings*" on page 59).
- Select another projection or enter depth values defining the safety limits (see "*Chart depths*" on page 60).
- Get more information about the chart and object with the Chart properties dialog (see "*Chart properties*" on page 64).
- Manage database (see "*Chart handling*" on page 67) including installation of chart permits (see "*Permits*" on page 68) or charts (see "*Install charts*" on page 70), updating chart database (see "*Update*" on page 71), checking the last updated objects (see "*Display updates*" on page 72), or the update history (see "*Update history*" on page 74). When errors occur during chart handling a message window displays the type of error.
- Install and update ENC charts on the Planning station and copy the chart database onto a remote PC (see "*Multi ECDIS workstations in LAN*" on page 75).

Chart display

Colors and symbols

The implementation of the SENC information display has been done in accordance with IHO regulations; colors and symbols used are compliant with IHO Special Publication S52 Appendix 2 V3.4 and IEC publication 61174 Annex E.

When a symbol is picked, the broken square sign indicate its state.



Course up display mode

ENC may be displayed in two different modes, Course up or North up.

To select the display mode, right click on the chart and check on or off the item menu Course up. North up symbol is shown in the top left corner of the chart area.

Cells borders

The cell boundaries are displayed on request using the dialog Chart properties. See "*Chart properties*" on page 64.

A plain grey line or a dashed line is displayed inside the chart boundary: it is the border of the Administration area. When the display is set to Display base or Standard, the area border is plain.

ECDIS draws the boundary between navigational purposes (also called Usages). For example, a boundary is shown around the total outline of all cells that belong to usage Approach.

Non-official data

If the chart display contains area with charts that are not official, the area boundary is indicated with thin red line with zone of diagonal stroke inside the area.

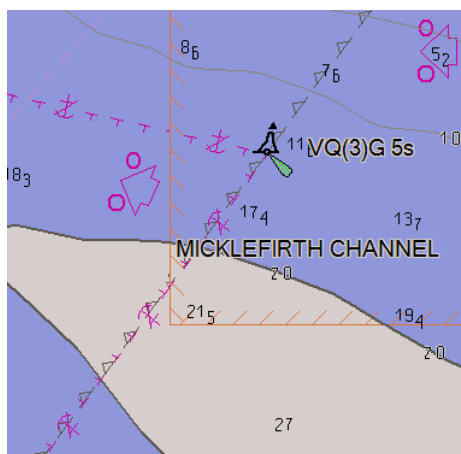

When the non-official chart zone is displayed, the indication **Non-ENC data** appears on the Legend panel.

No ENC data

If the chart display contains area with no charts, the area is filled with grey pattern.

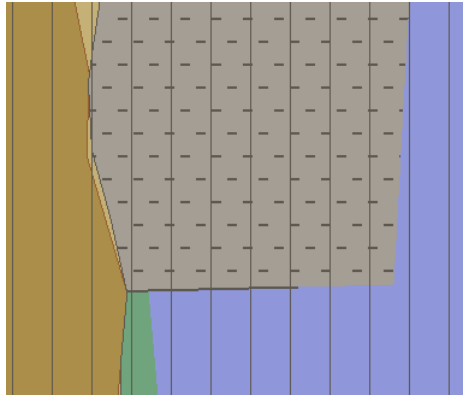

When this zone is displayed, the indication **No ENC data** appears on the Legend panel (see "Legend panel" on page 24).

Manual scrolling

Use a mouse and keyboard for scrolling charts.



1. Locate the cursor near the chart edge of the chart area and a **pan** pointer will appear, pointing in one of eight directions, depending on where the cursor is located along the chart edge.
2. Click the left mouse button to scroll the chart in the direction of the pointer.
3. Double click while pointing at the chart and the chart will be centered in that position.

Another way is to press the mouse wheel and drag the chart.

Use arrow keys to scroll the chart to north, east, south, or west. Click inside the chart area to set focus, then use the keys.

Other manual scrolling

Use the **Center on ship** function to center the chart on the ship. See "Center on ship" on page 33 for details.

Localization on the route

Select a route from the list and click the **Localize** button.

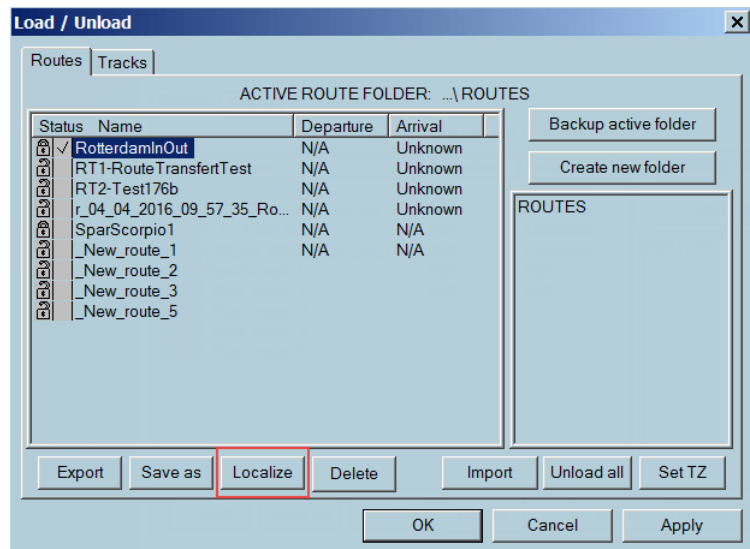

The chart is centered on the selected route.

Refer to "Load, unload, and delete route functions" on page 106.

Center on the target

Open the Target table dialog and double click on the selected target.



1468 targets in the table, (AIS: 1447)

Vessel name	MMSI	CPA	TCPA	Range/Be...	Ship type	Call si...	Navigatio...
▲ AIS ID:248976000	248976000	N/A	N/A	N/A	N/A	N/A	At anchor
▲ AIS IPOCHARD S	518896000	N/A	N/A	N/A	Cargo ship	E5U2...	Moored
● AIS ID:244730338	244730338	3.18...	N/A	33.68nm 76...	N/A	N/A	Moored
● AIS ID:244730339	244730339	3.18...	N/A	33.67nm 76...	N/A	N/A	Moored
● AIS ID:245738000	245738000	N/A	N/A	92.50nm 40...	N/A	N/A	Under wa...
▲ AIS ID:235103595	235103595	N/A	N/A	N/A	N/A	N/A	Moored
● AIS ID:244063556	244063556	24.7...	N/A	48.30nm 51...	N/A	N/A	Under wa...
▲ AIS ID:235103431	235103431	22.3...	N/A	40.51nm 48...	N/A	N/A	Under wa...
● AIS ID:205759310	205759310	N/A	N/A	35.31nm 19...	N/A	N/A	Under wa...
▲ AIS ID:235103305	235103305	N/A	N/A	N/A	N/A	N/A	Under wa...
● AIS ID:235103287	235103287	N/A	N/A	141.92nm 2...	N/A	N/A	Moored

Buttons: Hide targets, Draw true vectors, Lost targets..., AIS messages..., Customize table..., Start AIS server...

The chart is centered on the selected target.

Waypoint centering

Open the Route plan dialog. Double click on the Name of selected waypoint.

Route plan Fixed ETA function is not active.

RotterdamInOut

Distance - Time

Distance to go: 138.25 NM

Start Date / Time: 04/05/2016 22:03:50(-01) TTG: 13:52:01 ETA: 05/05 10:55:51(0)

Name	LAT	LON	DIST	CRS	Leg	Radius	ROT	XTD PORT	XTD STBD
WP_001	52 01.016N	003 44.823E	4.00 NM	082.6	RL	N/A	N/A	185 m	185 m
WP_002	52 01.535N	003 51.370E	3.33 NM	100.3	RL	0.50 NM	19.1°/min	185 m	185 m
WP_003	52 00.943N	003 56.617E	6.47 NM	110.7	RL	0.50 NM	19.1°/min	185 m	185 m
WP_004	51 58.643N	004 06.428E	3.17 NM	125.3	RL	0.50 NM	19.1°/min	185 m	185 m
WP_005	51 56.840N	004 10.537E	2.09 NM	123.2	RL	0.50 NM	19.1°/min	185 m	185 m

Buttons: WP properties, New WP by coordinates, New WP by bearing, Delete WP, Unlock route, Activate route

The chart is centered on the selected waypoint.

Refer to "Route plan overview" on page 102 for details.

Moving around the chart

Automatic scrolling

ECDIS900 automatically scrolls the chart in the following cases:

Route or user object plotting

To plot a waypoint or an user object outside the current S57 chart area, move the cursor in the desired direction, and the chart will automatically scroll in that direction. With a raster chart, move the cursor in the desired direction and the chart will automatically scroll in that direction until it moves outside the current chart. Left clicking on the black screen area outside of the chart border will load automatically the chart with the most precise scale.

Distance measuring

To measure the distance from one point to another point located outside of the chart, move the cursor in the required direction, outside of the chart area left clicking on the black screen area outside of the chart border will load automatically the chart with the most precise scale.

Waypoint move

To move a waypoint outside of the chart area, proceed in the same way as automatically scrolling the chart. With raster charts, the waypoint will appear on the next chart. Pick up the waypoint again by placing the cursor above it and holding down the left mouse button. Move the waypoint to the chosen location and release the left mouse button.

Follow the ship

Use the **Follow the ship** function for automatically scrolling the chart under the moving ship (relative motion).

For a detailed overview of the **Follow the ship** option, see "Automatic chart selection" on page 58.

Select area

Clicking the **Select area** icon in the tool bar and choosing a chart area name, moves and zooms the chart according to the pre-defined parameters (Scale and geographical location). For a detailed overview of the **Select area** option, see "*Selecting chart area*" on page 31.

Load a chart directly from Chart handling dialog

Double click on the chart name to load the chart.

⚠ Warning: Do not confuse Center the ship with Follow the ship.
Center the ship is a single command causing the ship will be centered on the display with the relevant chart area under it. The ship will then normally move away from the center (true motion). Unless the user re-centers the ship when it reaches the display edge it will move out of view.
The **Follow the ship** command causes the chart to scroll automatically under the ship (relative motion).

Automatic chart selection

Set follow the ship

To activate the **Follow the ship** mode, right click anywhere on the chart and select the menu item **Follow the ship**.

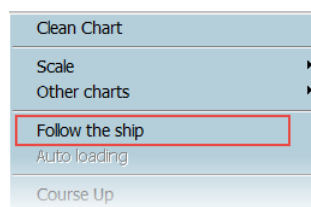

Operating in the Follow ship mode, the ECDIS900 automatically moves the current chart or loads new cells according to the ship's movements.

Auto loading mode

When the **Auto loading** mode is ON, ECDIS900 automatically loads new and displays the chart with the best scale at the ship's current position.

To activate the **Auto loading** mode, right click anywhere on the chart and select the menu item **Auto loading**.

→ **Note:** Activate Follow the ship function, then activate the Auto loading.

Short key

The **F3** key activates **Follow the ship** and **Auto loading** when the focus is in the chart window. If the key is not active, click once inside the chart area to change the focus.

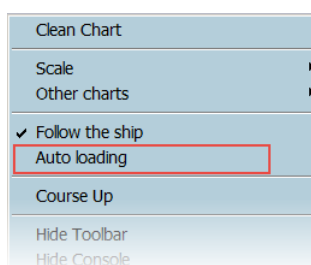

For ENC charts:

- If the Auto loading mode is OFF, the system moves the chart under the ship without changing the scale.
- If the Auto loading mode is ON, the chart scale will be changed if the system can load a chart with a scale more suitable for navigation.

Chart borders

Chart borders indicate the chart status and permit status for the particular chart.

→ **Note:** In case the chart is out of date or not installed, its border is displayed as dashed line. The color of line corresponds to the permit status.

The chart borders have color that corresponds to their status with following solid lines:

- red: the permit is expired or invalid for current HWID
- yellow: the permit will be expired in less than one month
- green: the permit is valid
- black: the chart does not need a permit

In the picture below the following charts are represented:

- green solid border: up-to-date chart with the valid permit
- green dashed border: out-of-date chart with the valid permit or the chart is not installed, but its permit is valid
- solid yellow border: up-to-date chart with the permit that will be expired in less than one month
- dashed yellow border: out-of-date chart with the permit that will be expired in less than one month, or the chart is not installed and the permit will be expired in less than one month.

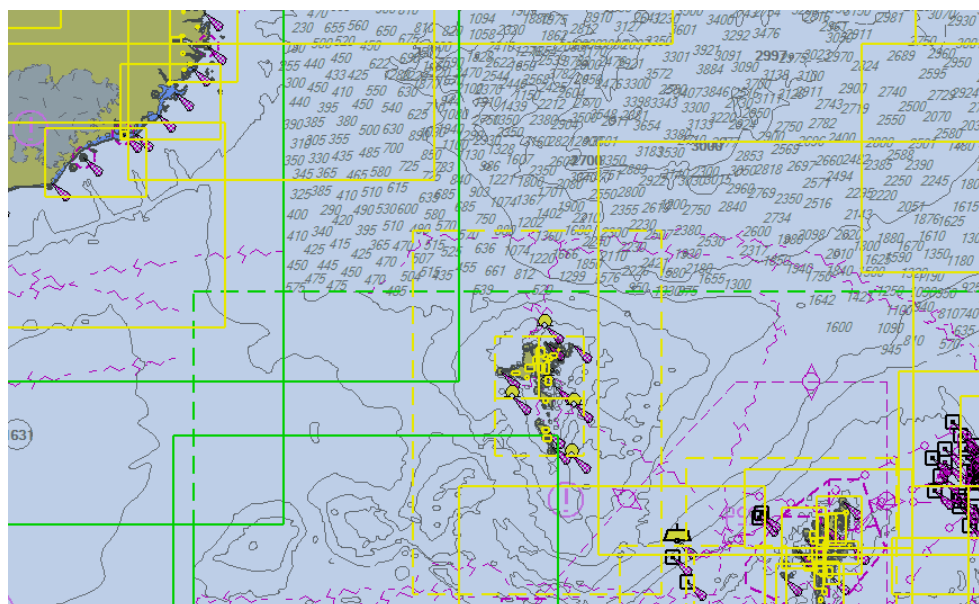

Chart settings

When a ENC chart is first displayed, the cell is displayed at the largest scale available in the SENC for the displayed area and the standard display provided. When several cells appear on the display the boundaries between cells are displayed.

→ **Note:** It is not possible to remove information contained in the display base.

The **Presentation** tab contains configuration settings of the chart display.

The **Chart Depth** tab is used for setting the chart projection type, safety and contours values, which depend on the ship characteristics (see "**Chart depths**" on page 60). These values are extremely important because they will change the chart display and be used for the anti grounding calculation.

The **Special Effects** tab contains ENC/ARCS/AVCS seamless mode options, flashing lights and manual chart band usage (see "**Special Effects**" on page 61).

For **Supplementary Layers** tab see "**AIO Layer**" on page 76.

Right click anywhere on the chart and select **Chart settings**.

Presentation Standard layer configuration

The default layers configuration is **Standard**. The set of layers to show is specified in IEC 61174, ed.4.

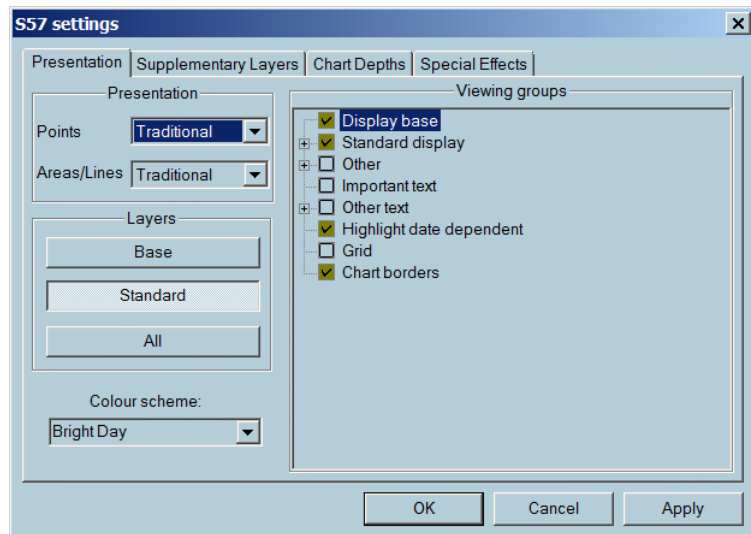

→ **Note:** Any change of the Standard configuration triggers the alert indication. The indication is displayed on the Legend panel of Console area. See "*Legend panel*" on page 24 for details.

The Standard configuration specifies the set of layers only. Color scheme and Presentation parameters can be changed without triggering an alert.

Other configurations

The **Base** configuration contains layers that must be always displayed: coastline, safety contour, isolated danger, aid to navigation, recommended routes, and traffic separation schemes. It is not possible to toggle off the **Display base** item.

The **All** configuration contains the maximum of layers to display, including depth spots, cables and pipelines, ferry crossing, names, depth contours deeper than the safety contour.

Presentation settings

With the Simplified presentation symbols are displayed in a synthetic way.

In **Paper like** presentation, the presentations of floating buoys are presented in their actual colors.

Points-Areas/Line options are the following:

- Paper like
- Traditional
- Simplified

Chart depths

Projection

ECDIS can display charts in different projections and guarantees the consistency between the datum used by GPS and the datum used in ECDIS for display and storage of routes, tracks and other objects.

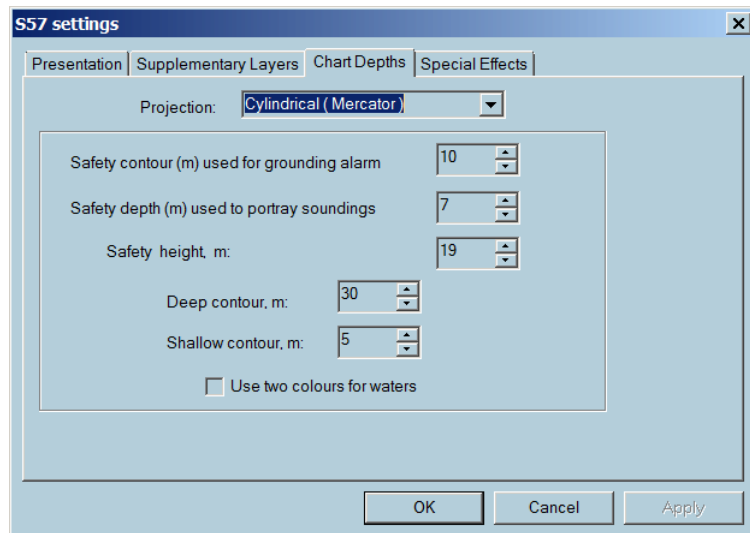

The default projection is Cylindrical, which allows displaying a chart in a proper way even in high latitude areas.

Depths

Deep and shallow contours can be displayed in two different colors. Tick the checkbox for **Use two colours for waters** option to switch colors.

- **Safety contour**

This function is used for setting a safe depth range for the given ship. The calculated safety contour is equal to or larger than the entered value if the depth contour chosen is not available on the chart. Safety contour highlights the safe navigation waters (See the example below) on the chart and ECDIS gives an alarm if the ship is going to cross the safety contour within the time limits specified in the safety guard zone parameters. By default the safety contour is 30 m. If the safety contour specified by the mariner is not in the SENC, the safety contour shown is the next deeper contour and the mariner is informed in the Legend panel. ECDIS emphasizes the safety contour with a wide grey line on the chart.

- **Safety depth**

This is the depth, in meters, below sea level that is considered to be safe for the ship. This is very important when the ship is approaching isolated dangers. On the chart the soundings with a depth value lower than the Safety depth are displayed in dark grey but the soundings with a depth value bigger are displayed in light grey color. Both soundings can be displayed or hidden by checking on or off the check boxes “Deep Soundings” and “Shallow Soundings” in the Presentation panels described above.

- **Safety height**

This is the height, in meters, above sea level that is considered to be safe for the ship.

- **Deep contour:**

This function is used for setting deep-water contour highlighted in the display of ENC charts.

- **Shallow contour:**

This function is used for setting a shallow water contour highlighted in the display of S-57 charts.

→ **Note:** The safety depth must not be less than the safety contour value.

→ **Note:** Depth information provided by ENC is not adjusted by tidal height.

Chart display depends on selected depth parameters.

“Examples” on page 63 shows that one chart has three different presentations according to different safety contour and shallow contour values.

Special Effects

ECDIS can make the light sectors flashing when the ship is closer to the lights than a fixed distance.

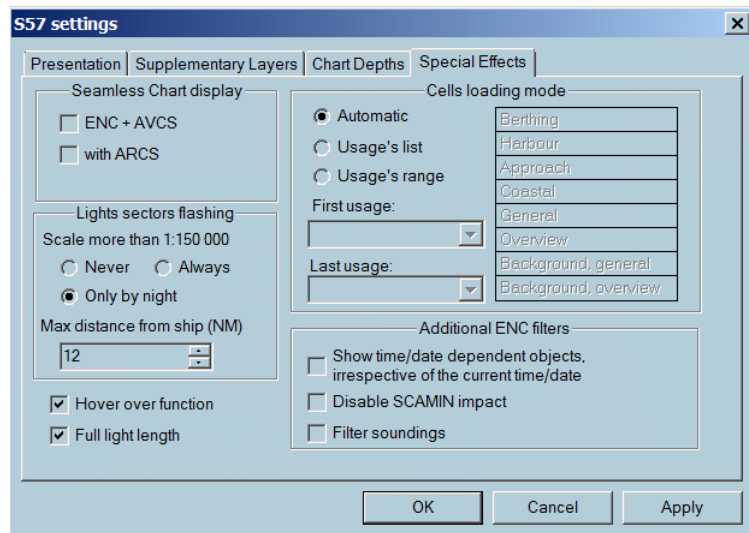

Seamless ENC/AVCS

If AVCS charts are installed together with ENC, both kinds of charts can be displayed in seamless mode, meaning that for the area of the screen not covered by ENC charts, AVCS charts are used to complete the coverage.

Seamless ENC/ARCS

If ARCS charts are installed together with ENC both kinds of charts be displayed in seamless mode, meaning that for the area of the screen not covered by ENC charts, ARCS charts are used to complete the coverage.

For more information see *"Seamless ENC/ARCS"* on page 95.

Filter soundings

For some charts the number of displayed soundings is too big making unreadable the figures on the chart. Filter sounding function reduces the number of soundings in such a way that in case of ambiguity the shallower sounding is always used.

Cells loading mode

The **Automatic** mode is default mode. When Automatic mode is activated, ECDIS900 scans all ENC database to load and display the proper cells for the scale in use.

When **Usage's list** is activated the scan of the ENC database is limited to the selected cell usages in the left list (Only Berthing and Coastal cells are used in the example below).

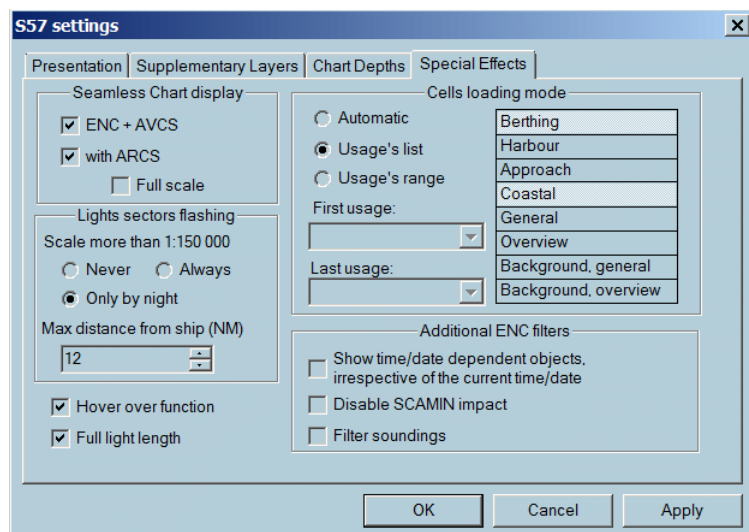

When **Usage range** is selected the scan of the cells is limited by the two usages selected by the user (From coastal to berthing in the example below).

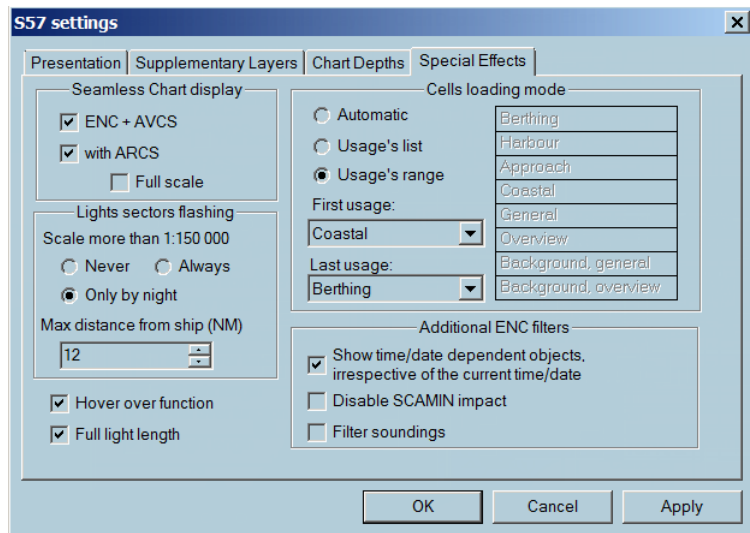

Toggle on the Disable SCAMIN impact to display all information at any chart scale.

Examples

Three charts are displayed with different values of depth and deep contour settings
The initial settings.

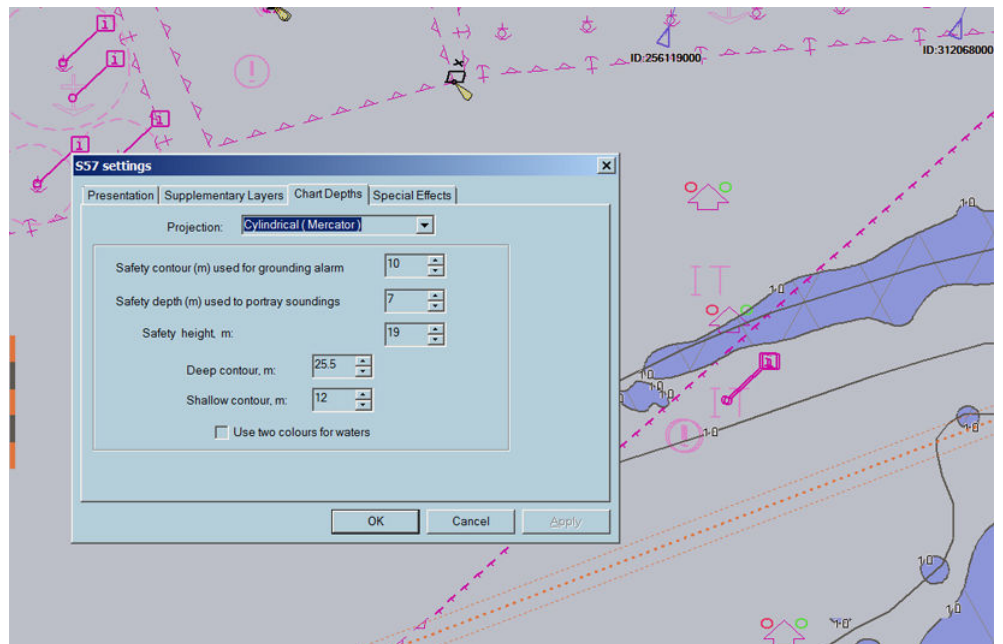

The deep contour value is changed.

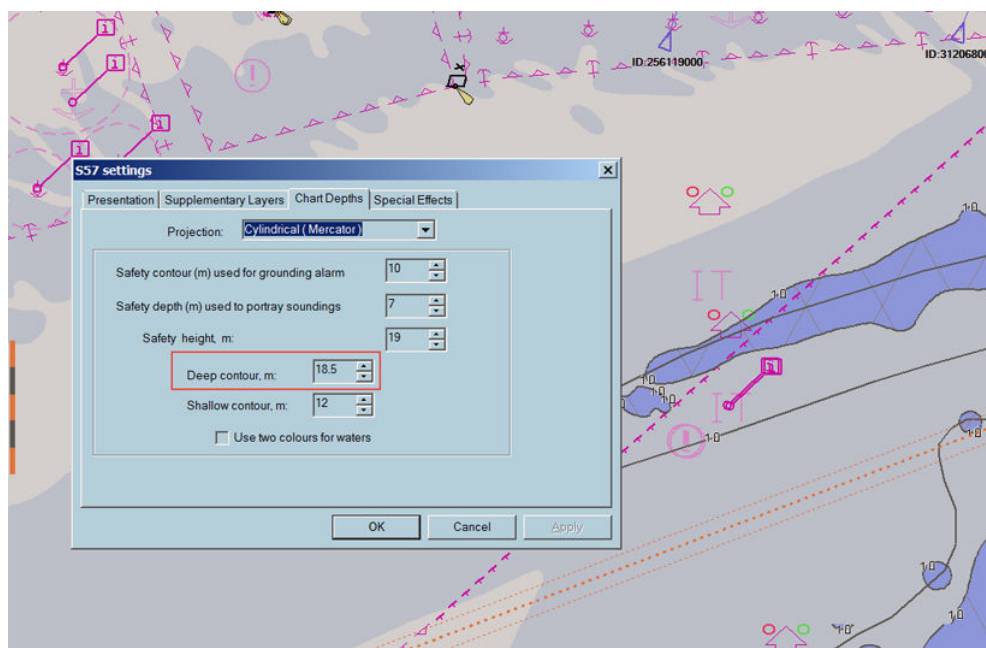

Then, the Safety contour value is changed.

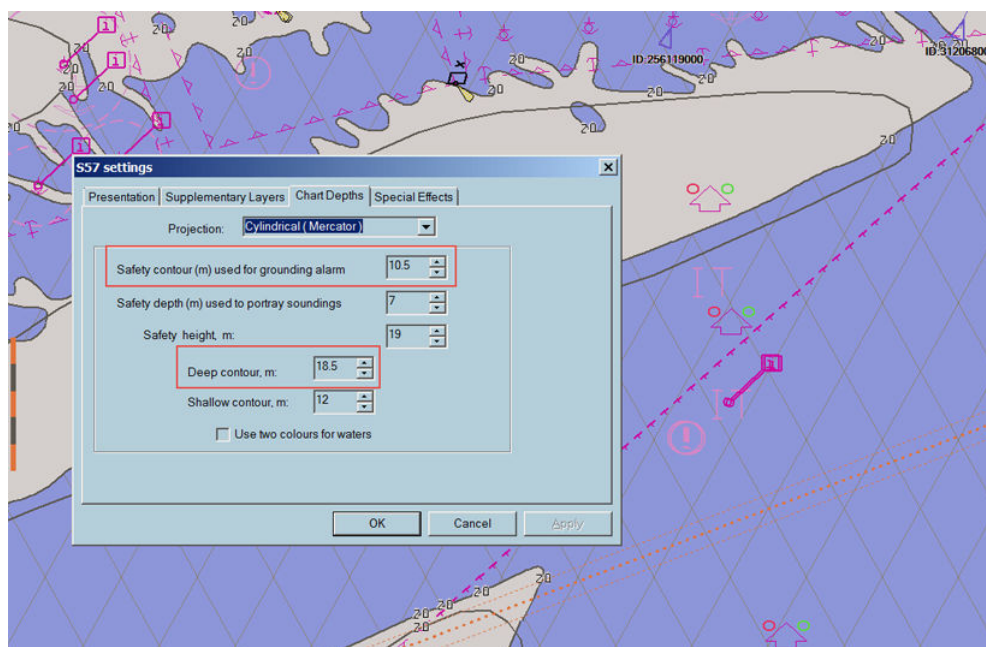

Chart properties

To view the chart cell's properties or to display information about an object of the chart, click right somewhere on the chart or on that particular object and select Properties. Alternatively press F4 when the cursor is on the chart.

ECDIS scans ENC database to find all objects present under the clicked point, highlights these objects on the chart and displays information concerning them and the cell the objects belong to.

→ **Note:** The properties of other points on the chart can be viewed, without closing the properties window, by clicking on selected points

Cell

The **Cell** tab displays general information about that cell, where the cursor is located. In particular cell boundaries, compilation scale, edition number, the version and Issue, the Issue and last update dates, etc.

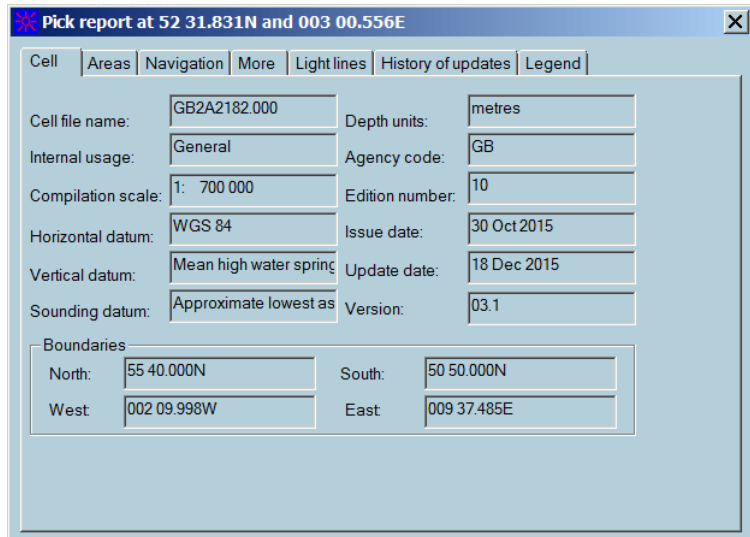

Areas

The **Areas** tab displays administrative information and area object data.

By default, objects of the category C are not displayed in the list. Click the **Cat C** button to make them visible.

To copy the entire list of area properties, click the **Copy** button.

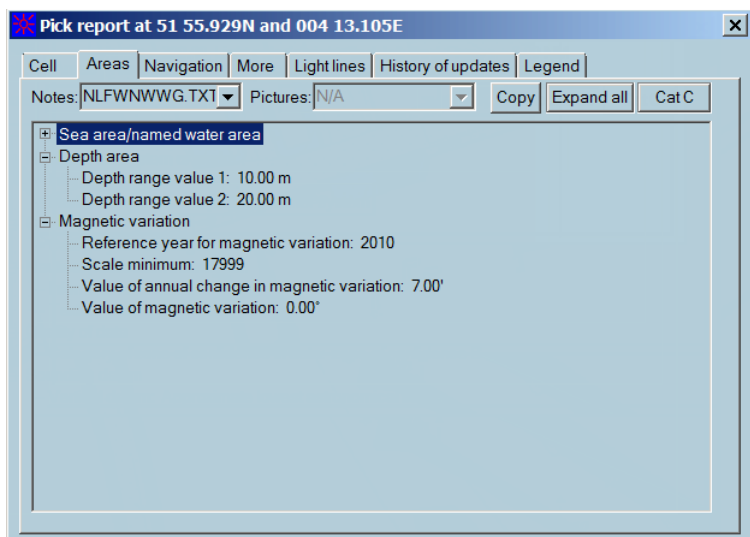

If area has some notes, the information symbol is displayed.

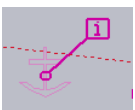

Navigation

The **Navigation** tab displays information about Navigation aids, lights, beacons, buoys, etc. If notes or pictures are associated with the selected cell, they are available in the appropriate drop-down lists. To open a note or a picture, select it from the list.

By default, objects of the category C are not displayed in the list. Click the **Cat C** button to make them visible.

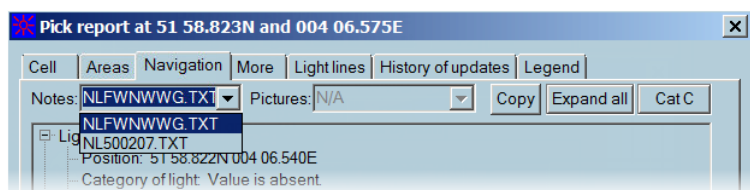

Also you can open these files without opening the dialog. Right click on the chart cell and select proper file from the pop-up menu.

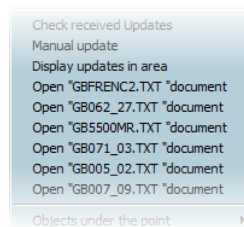

If notes or pictures are not in the menu, then the picked cell has no associated files. To copy the entire information of the tab, click the **Copy** button.

More

The **More** tab contains additional information about objects located under the cursor and displays the S-52 Presentation Library version.

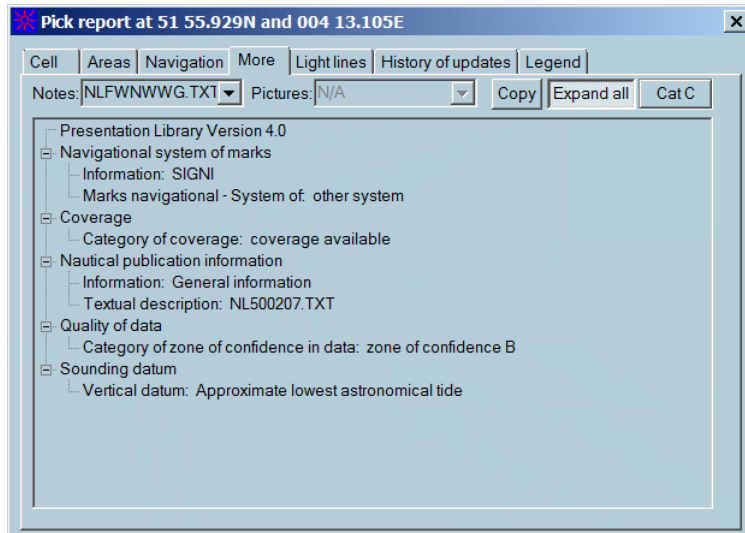

By default, objects of the category C are not displayed in the list. Click the **Cat C** button to make them visible.

To copy the entire list, click the **Copy** button.

Light sector lines

The **Light lines** tab displays light sector lines for a selected light.

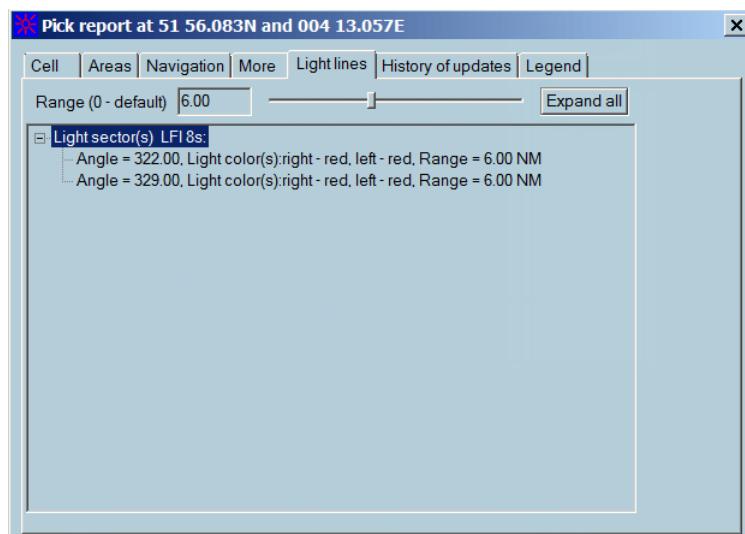

You can expand several or all sectors and set the range value. It helps to control very precisely the navigation when sailing towards the light or within selected chart sectors.

→ **Note:** These lines are displayed on the screen even the light is not visible on the screen. If there are no lights in the picked cell, the list is empty.

You can expand several of all sectors and set the range value. It helps to control very precisely the navigation when sailing towards the light or within selected chart sectors.

History of updates

The **History of updates** tab displays the list of updates for the cell (or cells if there are more than one cell is under the cursor).

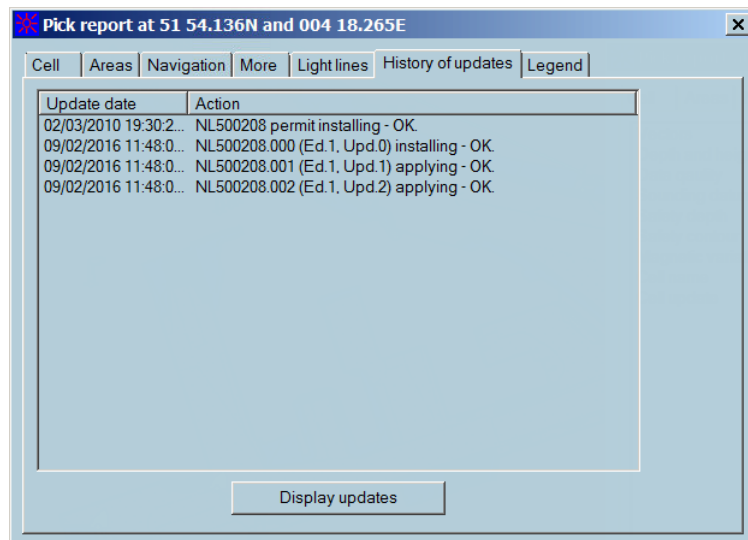

Legend

The tab contains information for any point of the chart display. The Legend panel in the Console area displays information for the ship position only. See "*Legend panel*" on page 24.

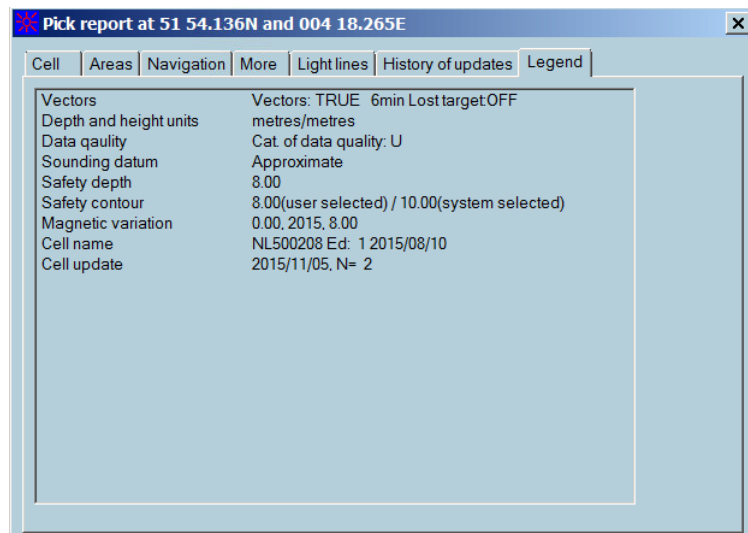
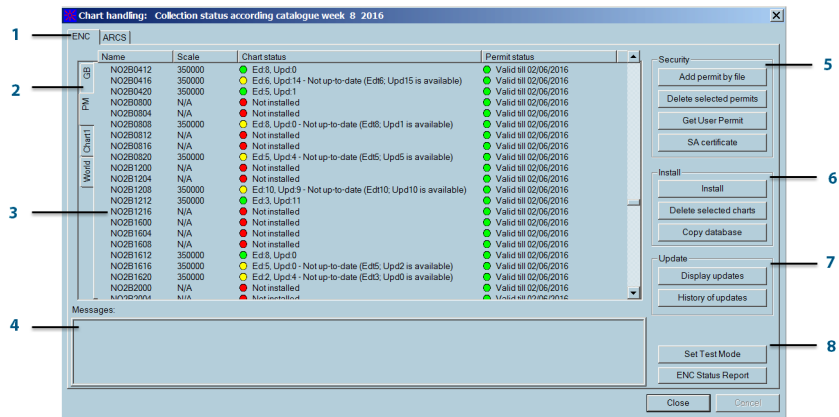

Chart handling

Click the **Chart handling** button to open the Chart handling dialog.

→ **Note:** The chart management is available from this dialog only.



- 1 **Type of charts** The horizontal tabs are for the chart types
- 2 **Chart collection** The vertical tabs are for the chart collections. The protected collections are:
 - **PM:** Primar
 - **GB:** AVCS
- 3 **List of charts** Entire list of charts and their statuses of the proper collection
- 4 **Message area** The action report is displayed in the Message area.
- 5 **Security buttons** The Security area contains buttons which provide work with permits and certificates.
- 6 **Installation buttons**
 - **Install** opens the ENC Installation wizard dialog.
 - **Delete selected charts** removes selected charts from the list. Hold the **Ctrl** key to select multiple charts in the list.
 - **Copy database** opens dialog for copying the current collection to the remote PC.
- 7 **Update buttons**
 - **Display updates** opens the Display updates dialog for the current collection.
 - **History of updates** opens the History of updates report for the current collection.
- 8 **Reports and testing**
 - **Set Test Mode** switches the system to the test mode
 - **ENC Status Report** opens the report for the current collection.

ENC security

The ENC protection is compliant with the S-63 standard. Security frame give access to the 4 following possibilities:

- Add permit by file
- Delete selected permits
- Get User Permit
- SA certificate

ENC cells are in general copy protected and therefore require permits.

→ **Note:** Some data providers deliver ENC cells without copy protection and therefore permits are not required.

Permits

ENC cells are in general copy protected and therefore require permits.

→ **Note:** Some HOs deliver S-57 cells without copy protection and therefore permits are not required

Ordering the permits

To order permits send to NAVICO the list of ENC cells of interest or a precise description of the area to be covered by ENC or a description of the routes you would like to be covered by ENC. Then MARIS chart service can establish the list of necessary charts and after confirmation the charts are purchased and the permits sent on board.

Add permit by file

The permits are delivered as 2 files:

- If the permit was received on a memory stick, plug in the memory stick and select the directory containing permits files.
- If the permit was received by e-mail browse the hard disk folder, open the permit file.

A message window gives information about the status of the installed permits and about eventual errors.

Permits from several providers

If ENC cells are delivered by two different providers (Primar and UKHO for example) two permit files are received on board. It is required to run two times the installation procedure with the two different permit files.

New permits

When additional permits for new charts have been ordered, a new permits file is sent on board. This file contains the complete list of permits purchased by the user and must be installed as described above. The new permits are added to the old ones.

Permits and chart version

When a chart is reissued (Old version is replaced by a newest one, stored in general on the chart update CD) a new permits file is sent on board. This file contains the complete list of permits purchased by the user and must be installed. The old permits are removed and replaced by the new ones.

ATTENTION

A permit is valid for a specific version of the chart:

- If the chart is too old for the permit, the user is informed and the new edition of the chart has to be installed.
- If the permit is too old for the chart, the chart cannot be installed and updated and a new permit has to be ordered.

→ **Note:** When the permit of one expires, the chart is still usable in ECDIS but cannot be updated and therefore cannot be used in Type approved ECDIS mode.

Delete permit

Click the **Delete permit** button to display the **Alert** dialog:

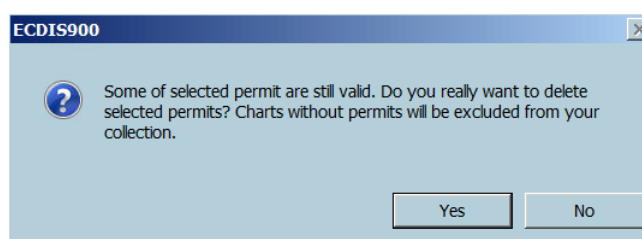

Click the **Yes** button to complete the process.

Once the permit is deleted, the chart is excluded from the list of collections.

Get User Permit

Click the **Get User Permit** button to display or save the user permit.

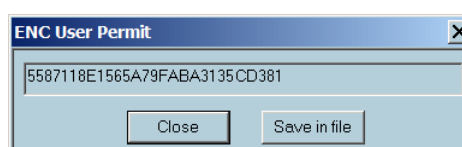

Use the **Save in file** button to save the permit in the local drive.

Get SA certificate

Certificate need to be installed.

1. Click the **SA certificate** button to install or display SA certificate.
2. Click the **Install SA certificate** button and browse folder to get ***.crt** file certificate.



Install charts

ENC charts can be installed from a CD or from a folder located on a remote PC.

→ **Note:** Before the installation make sure that the permits are installed.

All collection of charts stored on a CD can be installed at once by choosing the first option of the installation wizard.

The second option allows the user to make a selection of charts to be installed and the source of the data (CD or HD).

Make a selection of charts in the second dialog and click the **Next** button to start with the installation. For more details, refer to "*Chart selection*" on page 71.

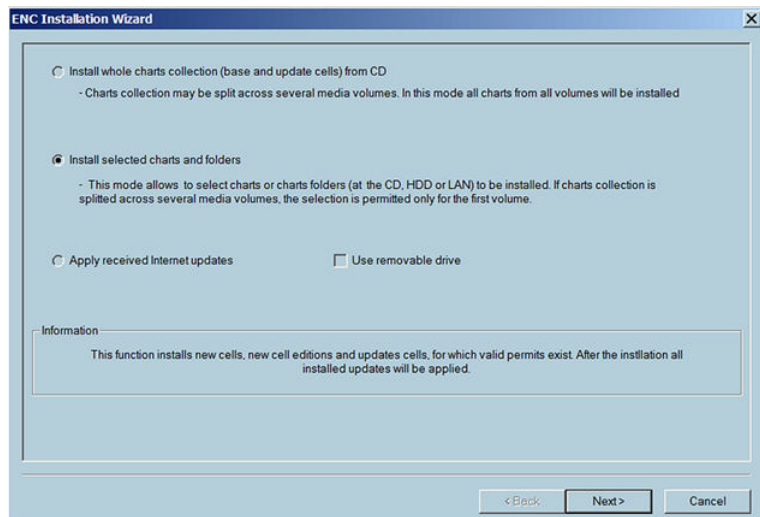

→ **Note:** European ENC charts and updates that are distributed by Primar and UKHO are delivered as **Base CD** which contains the chart database issued at the time indicated on the label and as **Update CD** which contains updates for the charts from the **Base CD**.

→ **Note:** The update CDs also contains the new chart edition issued since the Base CD was printed. The new charts and the new editions of chart stored on the update CD are automatically installed and updated during the update process.

Installation and update

After the charts are installed ECDIS tries to find updates of the charts on the same media. If the updates are found and have a correct sequence ECDIS automatically applies the update to the charts.

For a complete installation and update of European ENC's proceed as follow:

1. Insert Base CD
2. Click **Install**, select the charts to be installed and click the **Install** button.
3. Insert the Update CD
4. Click the **Install** button.

Delete charts

After confirmation the selected charts are definitively deleted from the chart database.

Errors, which may occur during installation are described in topic "*Encryption scheme errors in ENC*" on page 202.

Chart selection

Select the chart one by one by double clicking on the name or select a folder containing chart and click the **Add folder to the list** button.

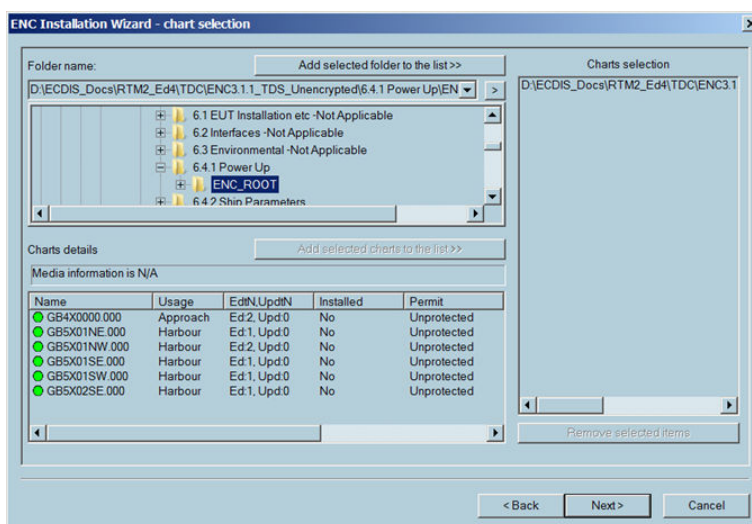

Update

Use the **Installation Wizard** to update charts. See the "*Install charts*" on page 70 for details.

→ **Note:** If a large number of charts are involved, the process may take some considerable time.

The function **See Updates** allows checking the last updated objects and the function Update history maintains a log of all applied updates (see "*Update history*" on page 74).

When **Cancellation update** is applied, the cell is removed from the collection.

Errors while update is in progress

If the updates are not correctly loaded or if an error is detected during the update procedure, the user is informed and the error message displayed in the message area.

- ECDIS rejects updates if the update issuing authority is different from the cell issuing authority.
- ECDIS rejects corrupted update files and files with wrong extension or wrong name.
- ECDIS checks that updates are applied in the right sequence. If one update is missing the next updates are rejected.

Example:

Single charts have update files with a specific order number, which is the suffix of the file: for example **Jp54nvpr.002** is the second update file for the Japanese chart called Jp54nvpr.

The file **Jp54nvpr.002** is a complement of the update information contained in the file **Jp54nvpr.001** but does not contain all update information that was included in the file **Jp54nvpr.001**.

In order to correctly update chart **Jp54nvpr** it is mandatory to first update the chart with file **Jp54nvpr.001** and then with file **Jp54nvpr.002**.

REMARKS

- An update CD-ROM contains in general all available updates for all ENC cells. ECDIS will automatically run all updates in the right order for all cells.
- Updates not relating to a cell within the set of installed cells are discarded.
- ECDIS rejects an update related to a new edition of the cell.
- ECDIS rejects an update related to an older edition to the cell.

Display updates

Updates are displayed:

- for a selected chart collection, when the Display updates function is called from the Chart handling dialog (see "*Chart handling*" on page 67).
- for a selected chart area.
- for charts under a selected route.

Display chart updates inside screen area

Right click anywhere in the selected chart area and select **Display updates in area** item from the list.

A dialog similar below is displayed:

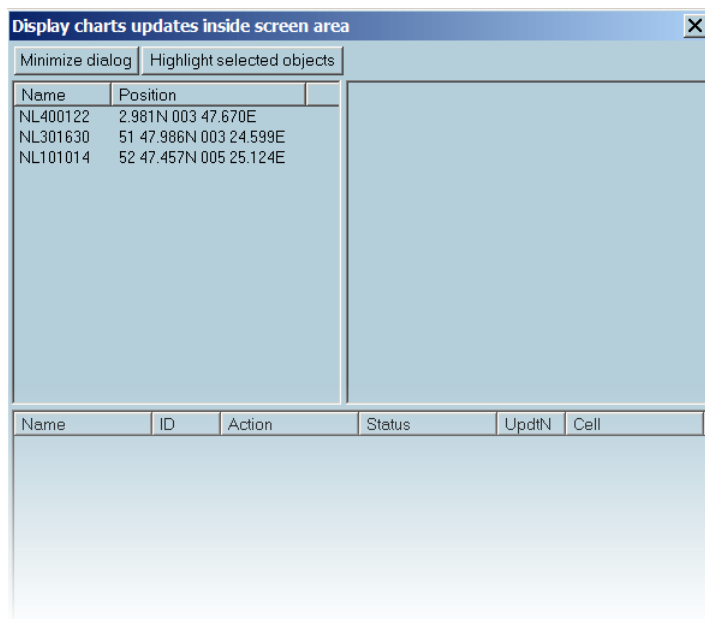

The left frame contains list of cells that were updated.

Click on the cell name to see the history of updates for the selected cell. The history is displayed as shown below:

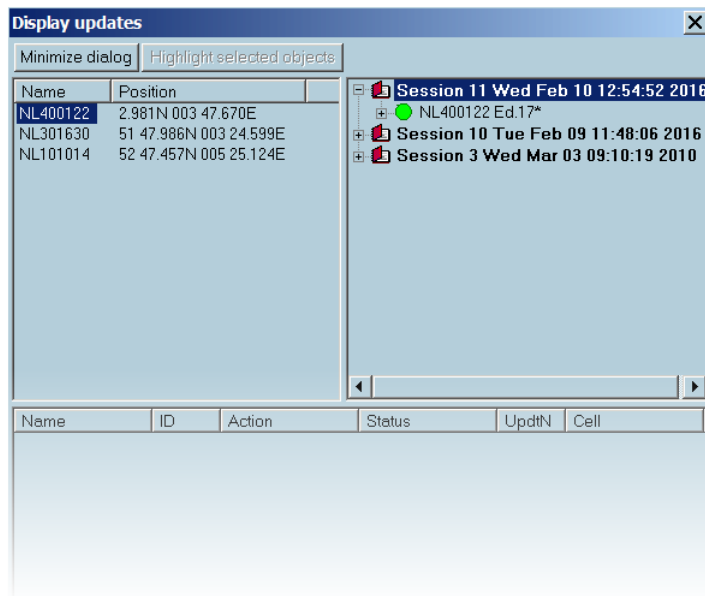

→ **Note:** If the selected session of update contains modified objects, it will be listed in the bottom frame of the dialog.

The cell names are identified as follows:

- Deleted cells are marked with red circles and a plus (+) sign.
- Newly installed cell editions are marked with an asterisk (*) sign, for example: NL400122 Ed 17*
- Old cells edition are marked with red circles.
- Current cell editions are marked with green circles.

The update names are identified as follows:

- Green circle in front of the update shows that the update review is available.
- Red icon is used when update are not available.

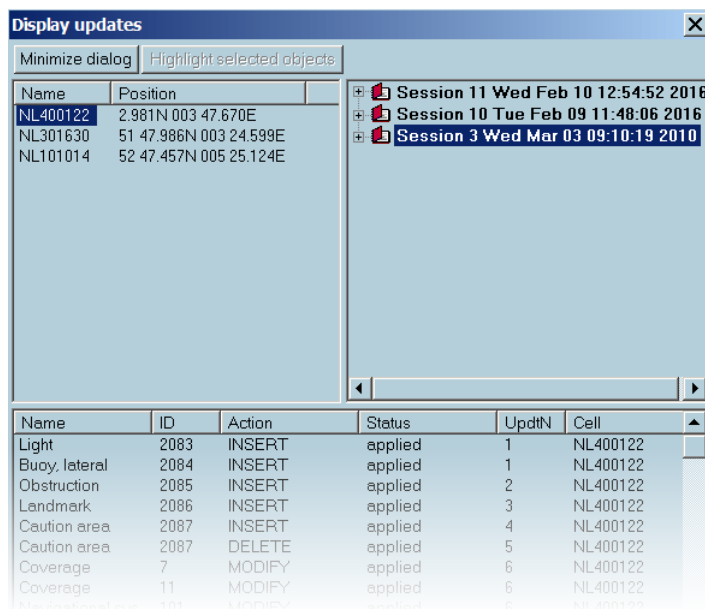

To expand the session list and view the session update, select the name of the modified object and click the **Highlight selected object** button. The chart is centered on the selected objects and they are highlighted.

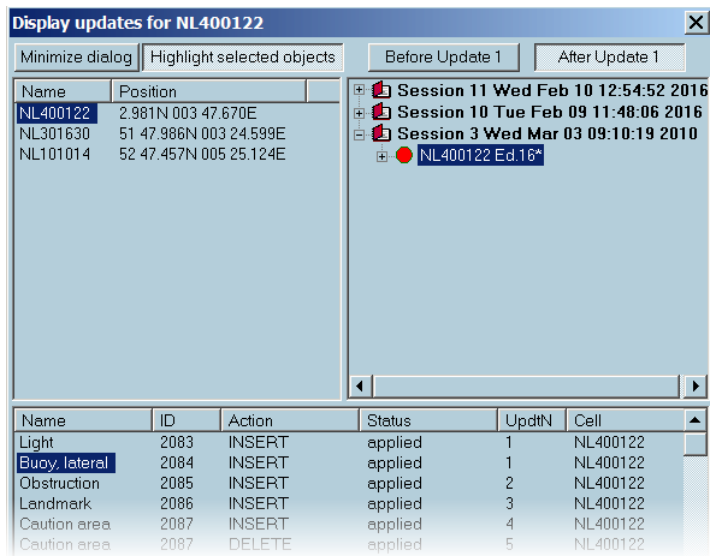

Use buttons **Before Update ##** and **After Update ##** for switching on and off the result of the update. **##** means the number of selected update.

Display updates under the route

Right click on the route and select the **Display updates under the route** item from the list.

→ **Note:** To display updates inside a selected chart area, right click on the route and select the **Display updates inside screen area** item from the list.

The list of cells contains updated cells under the route.

Update history

Update history of a collection

To display the update history of entire collection, click the **History of updates** button in the Chart handling dialog . An individual cell update history is available in the ENC properties dialog

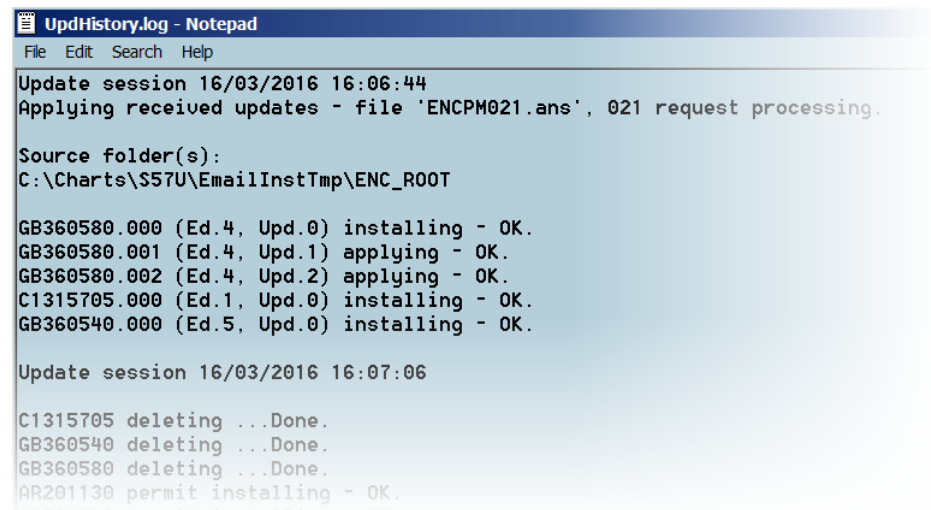

Display the update history with information about when the updates have been applied and which cells were updated.

Cancellation update

When an ENC chart is replaced by another chart a special update file is included in the updates. After update of the ENC chart database the old chart is automatically removed from the collection.

Multi ECDIS workstations in LAN

When ENC (or ARCS) chart installation and update is one workstation ECDIS gives the possibility to copy the updated database over the network making automatic the update of all ENC databases of installed together with ECDIS on the LAN.

Proceed as follow:

1. Install and/or update ENC database on the planning station.
2. In Chart handling dialog click the **Copy database** button.
3. The list of remote PC running ECDIS and connected to the LAN is listed in the dialog .
4. Select the PC(s) on which the ENC should be copied and click the **Copy Database** button.

Notifications

Some of the important information is displayed at the top of the chart area. The notifications of the following situation exist:

- Chart overlapping: when two cells with equal scales and usage overlap on the screen.
- Chart information is not up to date: when the displayed chart area contains charts with not up to date status. The indication is displayed while the chart status is changed or the chart is moved from the displayed chart area.
- NON ENC Data available! Refer to paper chart.
- Manual cells loading is activated!
- Some installed cells are not displayed due to invalid or absent cell permit.
- Permits of some ENC cells are expired. These cells may be out of date and **MUST NOT** be used for Primary NAVIGATION.
- SSE27 - Some ENC is not up to date. A New Edition, Re-issue or Update for this cell is missing and therefore **MUST NOT** be used for Primary NAVIGATION
- Time dependent objects can be improperly displayed
- S-63 test data mode is activated. To handle ENC data please switch back to navigation mode.

For more details about the time dependent objects, refer to *"S57 manual update editor"* on page 177 .



ENC status report

You can get charts status report both for a selected chart collection and for charts under a route.

Select the collection and click the **ENC Status Report** button.

To get the status report along the route, right click on the route and select the **Chart status report** item.

The report of chart status along the route is displayed.

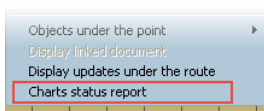
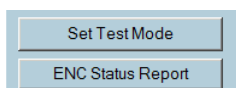

ENC PM collection status					
Vessel Name:	UNKNOWN				
Identifier:	IMO 0				
ENC Update Reference Date:	WK19 Feb 2016 : WK8/2016				
Date of Report:	22 Apr 2016 (14:29)				
Content:	Filtered for route plan "RotterdamInOut"				
Start WP:	N/A [52.016933N, 3.747050E]				
End WP:	N/A [52.011117N, 3.690067E]				
Chart Status Summary					
Chart Status:					Count:
Total:					18
Up to Date:					10/18
Not Up to Date:					8/18
Withdrawn:					4/18
Unknown:					0/18
Data collection: PM					
Cell name	Edition	Update	Issue date	Status	Permit status
NL68079B	1	0	17 Nov 2015	Up to Date	Valid till 02/06/2016
NL50209A	1	2	23 Sep 2015	Up to Date	Valid till 02/06/2016
NL101014	1	5	7 Apr 2015	Up to Date	Valid till 30/06/2016
NL50209B	1	0	29 Sep 2015	Up to Date	Valid till 30/06/2016
NL500207	1	8	26 Feb 2015	Up to Date - Not up-to-date (Edt1; Upd9 is available)	Valid till 02/06/2016
NL500208	1	2	10 Aug 2015	Up to Date - Not up-to-date (Edt1; Upd3 is available)	Valid till 02/06/2016
NL68093A	1	0	17 Nov 2015	Up to Date	Valid till 02/06/2016
GB2A218Z	10	1	30 Oct 2015	Up to Date	Valid till 02/06/2016
NL68113A	6	6		Withdrawn	Not found

Chart collection status report

You can get a report for any chart collection which is available in the **Chart management** dialog.

1. Open the Chart management dialog.
2. Select a chart collection.
3. Click the **ENC status report** button, the report is open.
4. If the selected collection contains more than 1000 charts, the system proposes to specify prefix for reducing the number of charts.
 - Select the prefix and click the **Print selected** button to get the report for the part of the collection.
 - Click the **Print all** button to get the report for the entire collection.
5. Click the **Print** button in the report window

Charts under the route status report

This report is for licensed charts of PM and GB collections only.

1. Right click on the route.
2. Select **Chart status report** from the menu.
3. Click the **Print** button in the **Report** window.

AIO Layer

A specific Information Layer, AIO (Admiralty Information Overlay) is available in areas covered by ENC cells present in AVCS collection.

Installing AIO

This cell, GB800001, is worldwide and data will be displayed in areas covered by ENC cells present in AVCS collection

A permit is necessary to install it, and it is displayed in Chart handling as others cells.

Activating AIO

AIO Data Display is activated from S57 Settings menu, tab Supplementary Layers:

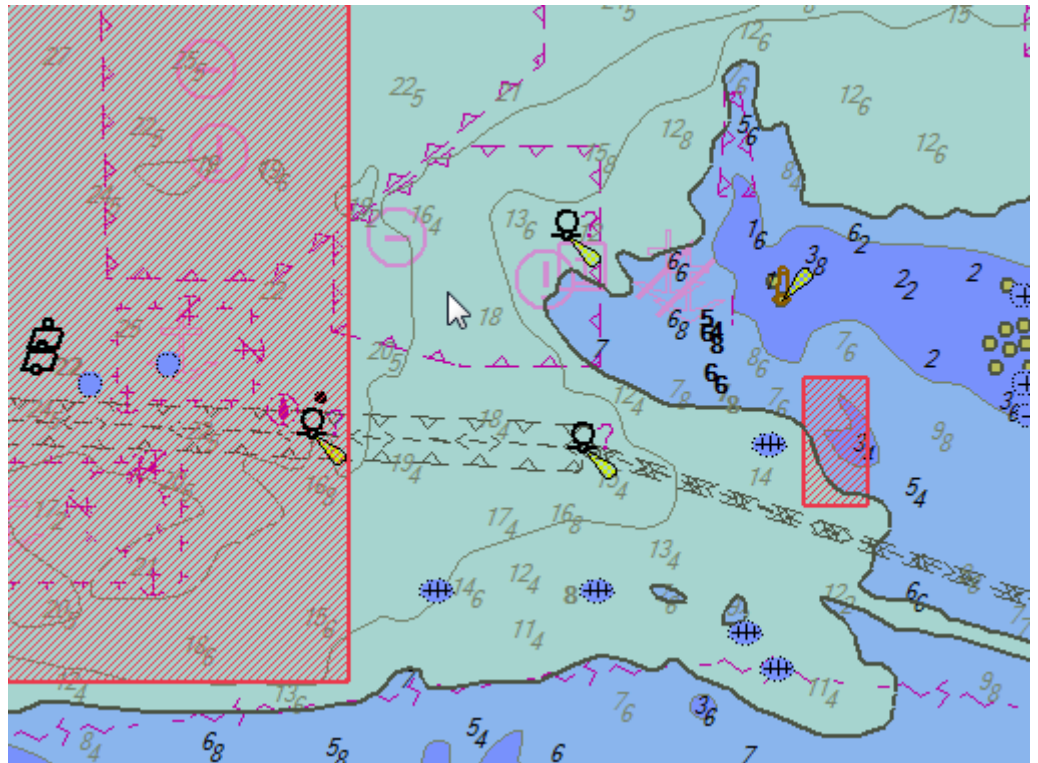
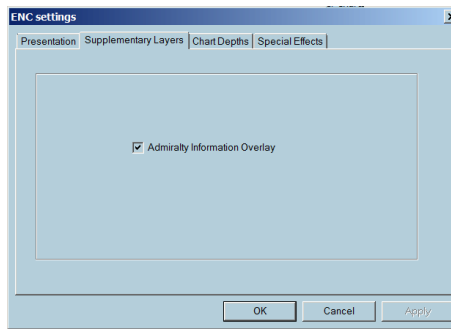

Information

Right click on red area and display T&P notice information in **Areas** tab.

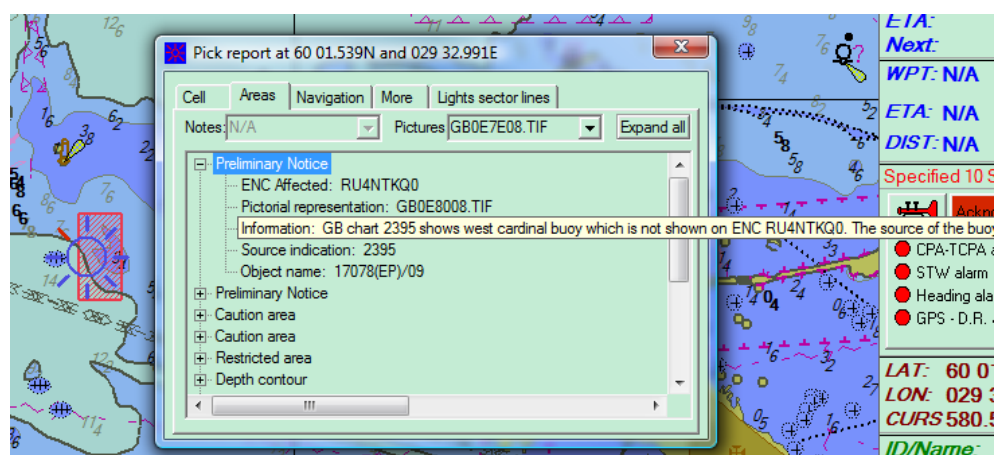

Update request and response

The online update is possible when the PC is connected to Internet. This can be done in different ways:

- The ECDIS PC is connected to the LAN and a PC on the LAN is the Internet access server with the MBA software installed.

- The ECDIS PC has the MBA software installed and uses a modem and the connection with the Internet provider is established manually.
 - A GSM is connected to the PC with the MBA software installed and the connection with the Internet provider is established manually.
- **Note:** It is also possible to use ARCS and ENC update services even when the ECDIS900 PC is not connected to Internet. Then it is necessary to use either a removable drive or USB memory stick.

The mariners are able to update:

- Only selected charts
- All charts necessary for a specific voyage
- All charts included inside the screen area
- All charts installed on board

Automatically the ECDIS900 checks the status of all installed charts and the last applied updates for each chart.

A file containing all information concerning the status of all charts and updates is created and sent by Internet to the chart server.

Response

After few minutes a user receives an answer.

ECDIS900 detects automatically answer from the chart server and applies the update to the database after informing a user.

C-MAP charts

C-MAP charts are ENCs that are compatible with ECDIS900 version . C-MAP offers not only ECDIS approved ENCs but also enhanced global coverage of digital charts. C-MAP charts are copyright protected. The user has to order and install the permits first before using the charts.

ECDIS900 is compatible with C-MAP ENC+ Service which offers global vector chart coverage. It contains only official ENCs approved to meet the SOLAS carriage requirements and the ECDIS mandate.

In areas where ENC is not available, high-quality vector charts produced by C-MAP are included.

C-MAP is an authorized distributor of ENCs from Hydrographic Offices directly and through Regional ENC Coordinating Centers (RENCs).

For more details, refer to the brand website: <http://commercialmarine.c-map.com/>

C-MAP chart database installation

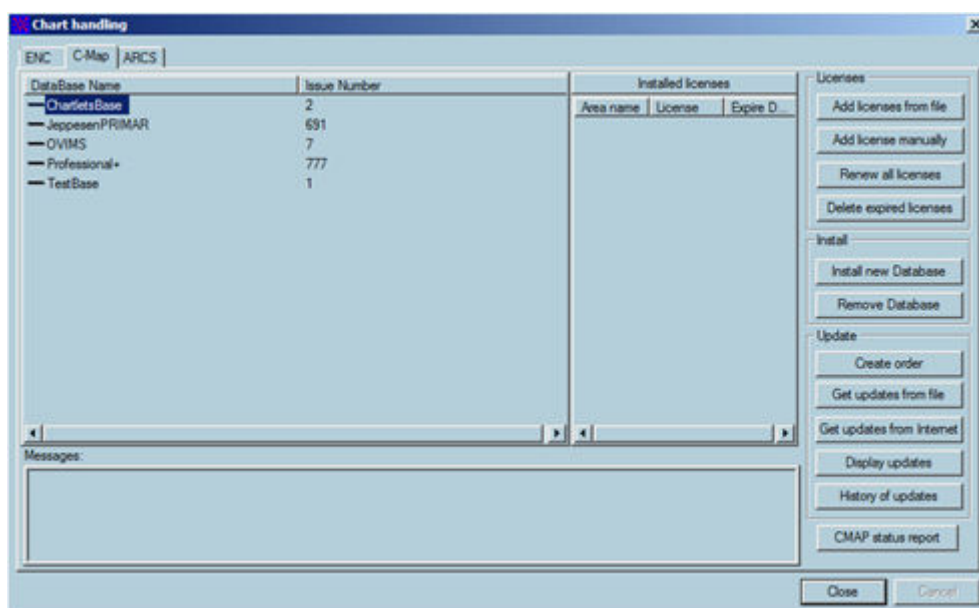

To install the C-MAP chart database, you need an eToken USB device, eToken key and C-MAP ENC+ service chart database DVD.

1. Insert the DVD into the DVD drive of the ECDIS computer.
2. Insert the eToken USB device into the USB drive of the ECDIS computer.
3. Click the **Chart handling** icon from the Toolbar panel to display the **Chart handling** dialog.
4. Select **C-Map** from the **Chart handling** dialog.
 - **Note:** **C-MAP** tab is only available if the C-MAP software development kit (SDK) has been included during the first installation of the ECDIS software. If C-MAP was not included, it is mandatory to uninstall and remove all ECDIS components and reinstall to ensure that the C-MAP runtime is selected and included in the installation. Refer to **Maris ECDIS900 Installation Manual** for more details.
5. Click the **Install new database** button.
6. Select the file called **C93_ROOT** from the DVD disc.
 - **Note:** The version or issue number of the database is displayed on the top of the window.

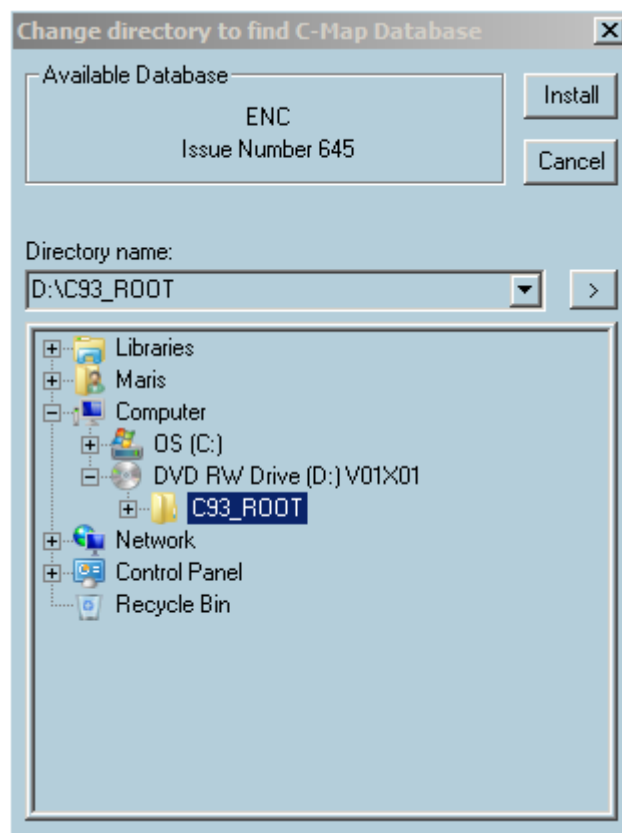

7. Click the **Install** button.
 - **Note:** e-Token USB should be inserted before and after the installation. This message will be displayed if the eToken is not yet connected to the ECDIS computer.

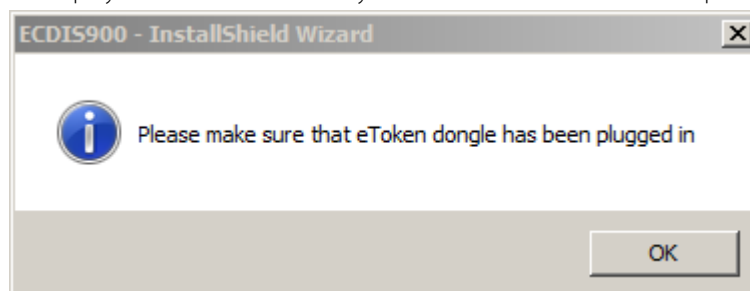

8. Click the **OK** button to complete the installation.

C-MAP chart licenses

C-MAP licenses are paid in three different options: Direct, Dynamic (Pay-Per-View) or OpenENC (Pay-As-You-Sail). C-MAP ENCs are converted into DNV approved SENC format which prevents a time-consuming and risky data conversion on board.

ECDIS900 version can use C-MAP ENC+ service which can be supplemented with the C-MAP Professional+ global chart database. If several ECDIS use C-MAP on board, several permits are required (one assigned ENC permit number and one assigned e-Token per ECDIS device) even the user has only to pay for one C-MAP license. When the installed C-MAP database is updated or a new version of the database is reinstalled, the permits are still valid and can be used with the new version of the C-MAP database.

For comprehensive details on licensing and updating chart database, please refer to the brand licensing page: <http://commercialmarine.c-map.com/en/licensing-and-updating/c-map-licensing>.

eToken USB device

eToken is a dongle that is inserted in the USB port of the ECDIS device. eToken contains unique information that provides an additional functionality to the ECDIS system. Each ECDIS device running with C-MAP chart database is assigned to a separate eToken device with a unique eToken key.

An eToken key is a short number used to identify the system which is written on a small tag attached to the eToken USB device. A license made for a particular eToken will work only in combination with the particular key which it is made for.

- **Note:** It is mandatory that the eToken USB device should not be removed from the ECDIS computer before or after the installation of the C-MAP chart database.
- **Note:** NAVICO is not responsible for replacing the chart permits and other contents of the eToken. Please insure dongle and all chart permits against theft, loss or damage.

Ordering permits

Permits are ordered in three different options: through email, phone call or through MBA or MCP. The following is mandatory before ordering the permits:

1. Ensure CMAP chart database is installed in the ECDIS system.
 2. Provide the Route plan, ENC user permit number and/or the e-Token keys of each PC that has ECDIS and C-MAP to Navico customer service. It is recommended to send it via email to chartservice@maris.no.
- **Note:** Customers can also obtain support with regards to ordering permits via MBA or MCP by contacting chartservice@maris.no.

Installing the permits manually

1. In the **Chart handling** dialog, select the **CMAP**.

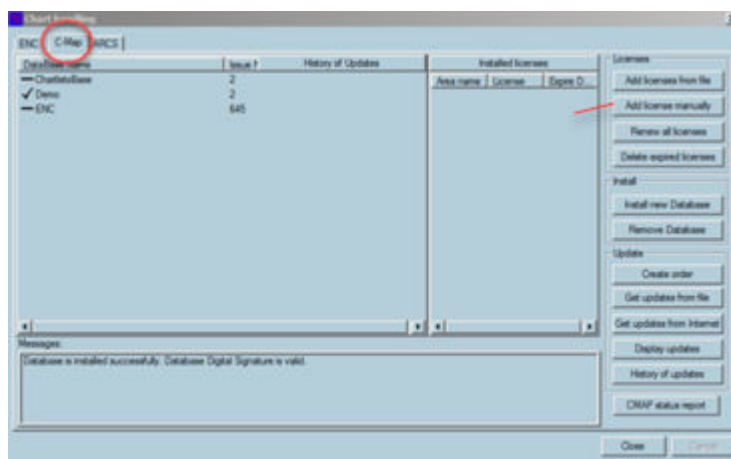

2. Click the **Add license manually** button.
3. Select the zone or area related to the permits.
4. Enter the permits (16 characters)

5. Click **Add license**.

- **Note:** If several zones or areas have been ordered several codes have been received then repeat the operation for each zone. The code contained 16 characters and the application activates the button Add license only if the entered code contains 16 characters.

Installing the permits by file

To install the permits received by file, select the folder that contains the "**permit.txt**" and the installation is automatic.

Chart update

Updates on C-MAP chart database can be downloaded daily via online communication (email or Internet/HTTP). To get access to new charts, it is recommended that you receive a complete updated database regularly via Online+Service or DVD

For more details, contact NAVICO at chartservice@maris.no.

Update by DVD

A single DVD containing all updated C-MAP charts is automatically sent to each C-MAP subscriber.

- **Note:** The chart permits are still valid and must not be re installed.

Update via the Internet (HTTP)

Proceed as follow:

1. Establish the communication to your Internet provider.
2. Click the **Get update from Internet** button in the **Chart handling** dialog.
3. Then the procedure is automatic and several messages displayed in the **Messages** area of the dialog give information about the process.

The Copy database function allows a user to update other ECDIS station by LAN after Update is completed. See "*Copy database*" on page 82 for more details.

Update via email

Proceed as follow:

1. Create an update request by clicking the **Create order** button
2. A file called UPDATES.ORD containing all necessary information is created.
3. From a communication computer on-board or from a shored-based PC, send an email with the file UPDATES.ORD as attachment. The address of C-MAP Update server is updates@c-map.no.
4. The request is processed and updates returned by email.
5. Copy attached files containing updates (u00100N.ans to u00N00N.ans) on a memory stick and insert it in the ECDIS PC.
6. Click the **Chart handling** button and select the **C-Map** tab :
7. Click the **Get updates from file** button and select the file to update the database.

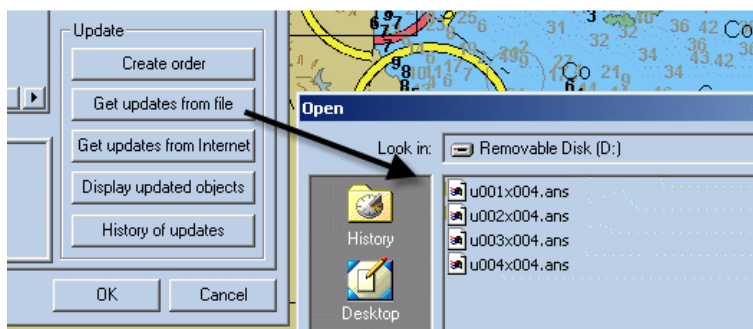

The **Copy database** function allows updating other ECDIS station by LAN after update is completed.

C-MAP subscriptions and update service

Coverage and zones



Zone 0 is the world wide coverage.

User subscribing to C-MAP chart database receives a single DVD.

The user shall perform the installation of the database and use the same permits all along the year for each new DVD.

License status

The installed license status is displayed in the **Chart handling** dialog. The license status includes:

- Zone or area ID
- Permits
- Expiry date for the permits

To renew the chart permits before expiry date send to NAVICO an order for license renewal. A renewal code will be sent back and entered using the button **Renew All Licenses**.

Copy database

Copy database function is used to install the new updates in other ECDIS devices. It is used to synchronize a remote ECDIS by LAN.

1. Select accessible path and click the **Copy database** button.
2. Click the **OK** button to finish

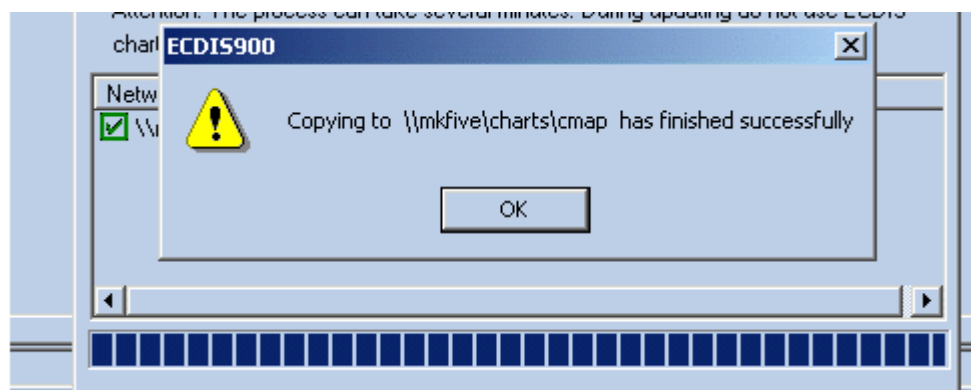

3. Acknowledge database transferred on the remote ECDIS by clicking the **OK** button:

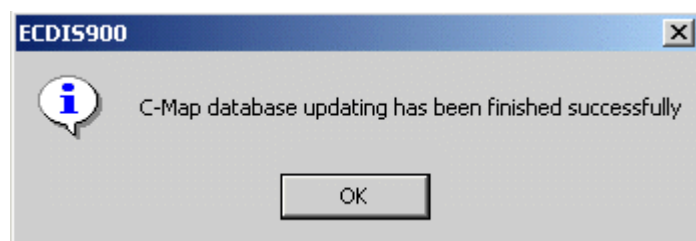

→ **Note:** Updated objects from the database will be available after updating other ECDIS devices using the **Copy Chart Database** option. **History of Updates** option will be greyed out.

Using C-MAP charts

Select C-MAP by either right click menu "Other charts" and selection of CMAP or by using the hot key F9 properly pre programmed or by double clicking on the world database name in the Chart handling dialog panel CMAP.

C-MAP database is used in the same way than official ENC data with very little difference. For more information about vector chart in ECDIS refer to the chapter S-57 charts.

Chart settings

Select S52 view to display the vector char using official Presentation Library or C-MAP view to display with C-MAP presentation.

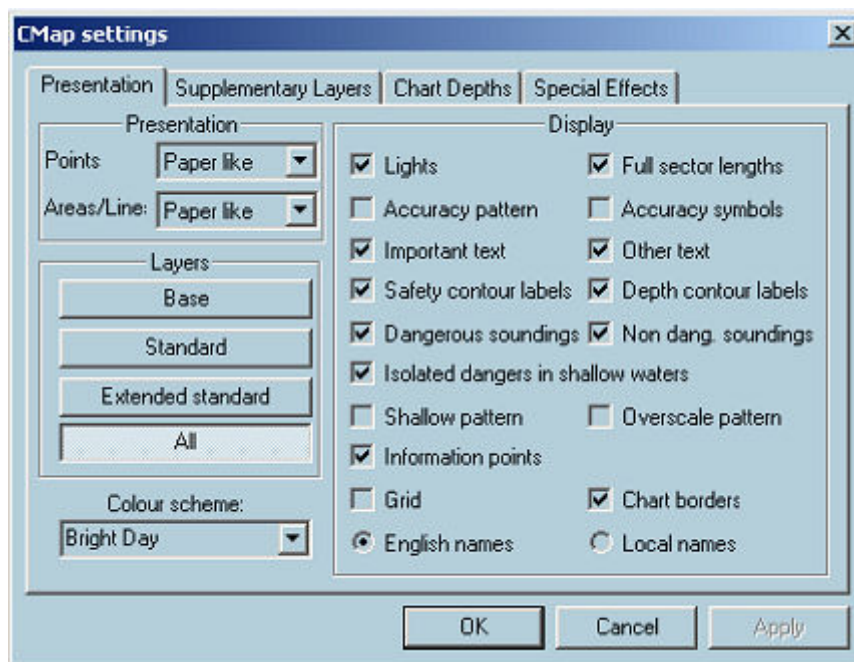

History of updates

Click the **History of updates** button to get all information regarding the updates applied to the database.

Display updated objects

From the **Chart handling** dialog, click the **Display updated object** button to see the changes on the chart.

Select the update ID to be displayed by choosing the HO and the ID of the update.

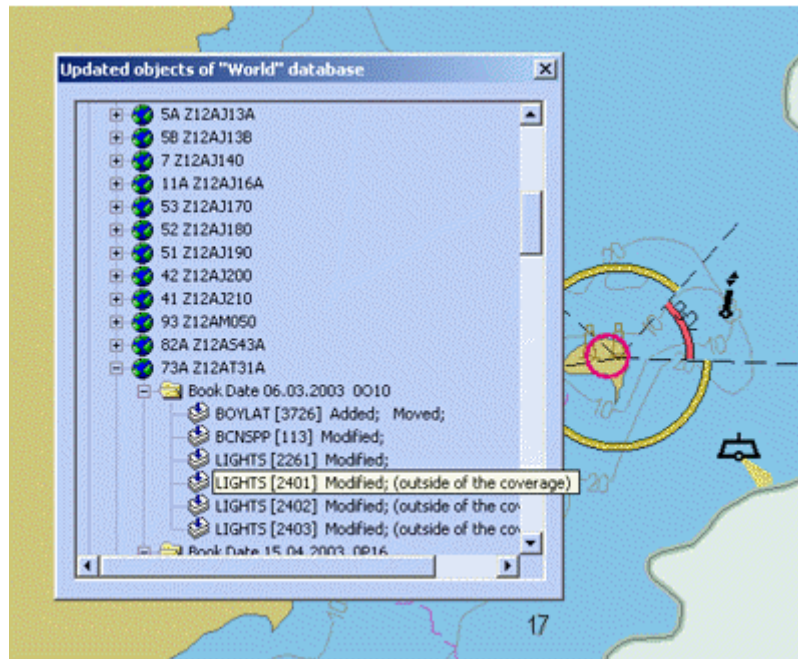

The selected update is highlighted with pink circle and color.

ARCS

By default, ECDIS displays charts in a chart-by-chart mode. However the option **Seamless mode** (see *"ARCS seamless mode"* on page 94) is available making it possible to display the active ARCS chart together with adjacent charts in a seamless way.

ARCS charts are scanned copies of paper charts. A displayed ARCS chart includes the same information as appears on the copied paper chart. Source information about each chart is accessible from the **ARCS properties** dialog.

Copy protection

ARCS charts are copy protected with a dongle. In order to use and display ARCS charts in ECDIS it is necessary to:

- Enter a valid ARCS PIN code when required.
- Install ARCS chart permits.
- Install the charts from the CDs and update them.

ARCS and multi ECDIS workstations

Where several ECDIS workstations are installed on board, duplicate dongles can be provided using the same ARCS license. The chart licenses and updates have to be installed and updated locally on each workstation.

Using ARCS charts

In this chapter the user will learn how to:

- Access to the Chart handling dialog (see *"Chart handling"* on page 85) to get all information about the chart database, to install, delete or update charts
- Install chart permits (see *"Permits"* on page 86)
- Install new charts (see *"Install charts"* on page 87)
- Update the charts manually (see *"Updates"* on page 88)
- Interpret errors that may occur during installation or update (see *"Common errors in ARCS chart management"* on page 203)
- Switch to ARCS (see *"Switching to ARCS"* on page 90)
- Zoom and change scales (see *"Zooming"* on page 91)
- Modify the layout of the chart with the chart settings (see *"Chart settings"* on page 92)
- Access to the chart properties (see *"Chart properties"* on page 92).
- Update paper charts with aid of ARCS updates (see *"Help for paper chart correction"* on page 89)
- Check the chart collection status including all applied updates references and dates of updating (see *"Chart collection status"* on page 94).

RCDS mode

When an ARCS chart is selected (right click on the chart and in the pop-up menu click **Other charts/ARCS**), the proper chart will appear on the display and the RCDS mode is indicated in the windows title bar at the top left hand corner of the screen.



In addition to the name and ID of the charts, ECDIS900 displays the datum of the chart and the datum shift between this datum and WGS84.

→ **Note:** When no datum information is available for the chart, the system displays the message 'Undetermined' in the windows title.

ENC data available indicator

When a route is checked for danger, an indication is given when the route crosses an area covered by ENC data. When a route is being monitored (see) an alarm is given when the ship enters an area covered by ENC data.

Chart handling

The ECDIS900 software is copy protected with a dongle and Personal Identification Number (PIN).

Each ARCS chart permit has a unique 40-digit code linked to a UKHO User Permit Number issued against a customer PIN.

The PIN number must be entered when asked on the first occasion ARCS charts are installed. The ARCS User License Number (6 digits) is required when ordering charts.

Entering PIN code

If the PIN is invalid, a warning appears and the mariner has to re-type the PIN code.

If, after the three attempts, the user has still failed to enter the correct PIN, the system does not allow the user to enter the PIN again for a certain time.

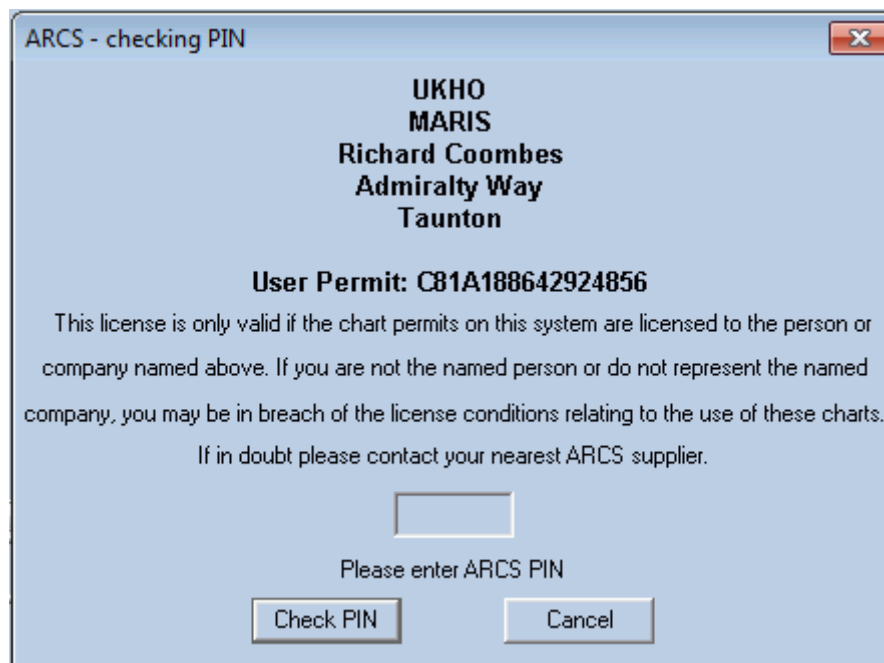

If the problem persists, contact NAVICO support.

Chart handling

Management of the ARCS chart database is carried out within the Chart handling dialog. Select the ARCS tab and install permits or charts or delete charts or update the database or access the collection status from this dialog.

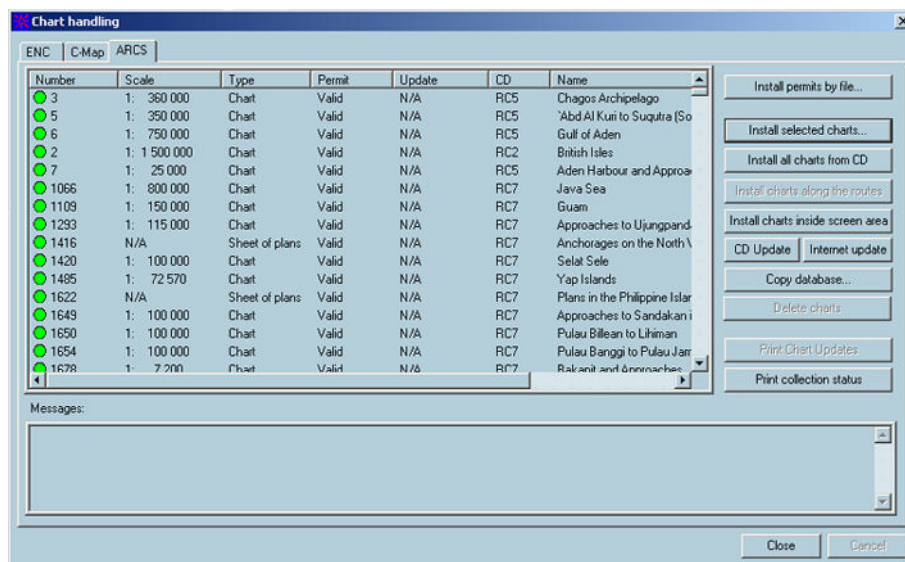

Permits

To display charts in ECDIS900, it is necessary to enter a permit for each chart. Each ARCS chart permit is encrypted and linked to the licensed users **User permit number**. Chart permits can be delivered as a file containing the code for each chart or as a 40-digit text message sent by email or fax. In both cases the first step towards installing new charts is to install the chart permits.

The UK Hydrographic Office (UKHO) has eleven ARCS area CDs (with about 300 charts on each) available for users. Area chart CD's are issued free to licensed users by the UKHO distributors. These area CD's are re-issued when a sufficient number of charts on the CD have been re-issued as new editions or cancelled.

Until the area CD is re-issued, the new edition charts are provided for the user on the weekly update CD.

In addition to new edition charts, each weekly Update CD contains the cumulative correctional data for all ARCS charts.

The only type of ARCS license is available:

- **Navigator Service.** This service is designed for commercial ships that require a fully up to date chart outfit. The user will be licensed to a specified chart holding for a defined period of time. Within this period the user will be entitled to freely access all Notice to Mariners and New Editions that relate to the licensed chart holding. At the end of the licensed period the user will have to renew the license or will no longer be able to access any of the charts.

Install permits by file

1. Click the **Install permits by file** button
2. Browse the computer to select the appropriate folder **CONTAINING** the permit files. The Navigator files are named **gb.lcn** and **gb.ncp** and the Skipper files are named **gb.scp**. The new files are automatically sent to the correct folders in the ECDIS software.

Users normally receive permit files in a folder sent by email, or on a memory stick sent by post.

Warning: Clicking the Install permits by file button installs permits. This function deletes the existing chart permit file, overwriting it with the new one and therefore should only be run the first time that permits are installed.

- **Note:** When new permits are ordered or when the permits are reissued, the files received from UKHO by email or memory stick contain all permits, the new and the old ones.

Install charts

ARCS charts are delivered on 11 Area CD's (RC1 to RC11). Each Area CD covers a defined geographic area (see ARCS Area diagram). New Edition charts for all areas are initially placed on the Weekly Update CD. When a sufficient number of charts on an area CD have been replaced by New Editions, a new Area CD is released with all New Editions included.

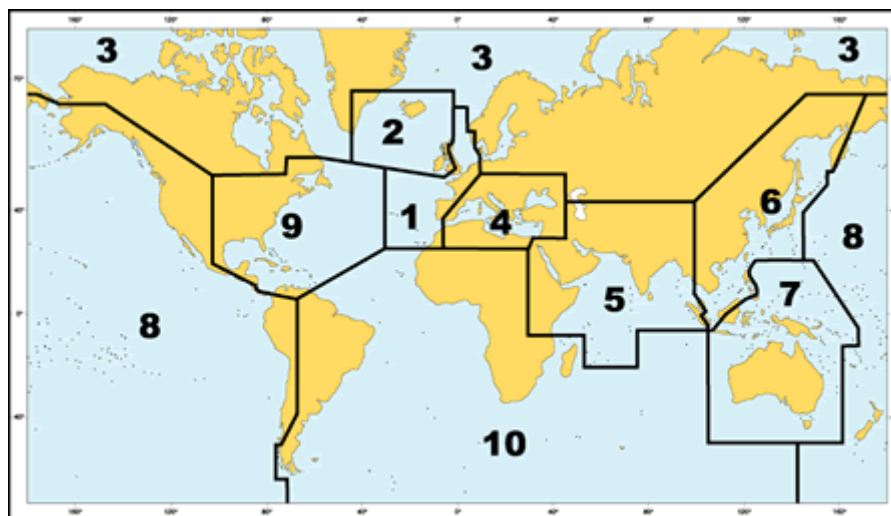

→ **Note:** At any time, up to ten per cent of the charts on an area CD may have been replaced by New Editions contained on the latest Update CD. Users should always install relevant New Edition charts from the Update CD before applying the Updates. The update CD contains the latest ARCS chart catalog plus cumulative updates for all charts in the catalog. Each Area CD and Update CD has the date on the label. Only the latest CD of either type should be retained on board and used with the system.

Install selected charts

1. Click the Install selected charts button and the system will list all charts on the CD-ROM along with the parameters: Number, Scale, Permits, Status, and Name.

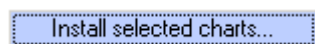

2. Make a selection, using standard windows procedures, and click **Install**.
3. Click **CTRL + Install selected charts button** to select CD in a shared drive in the LAN.
4. The charts with a valid installed permit are displayed with a green spot in the left hand column. If the permit is not valid the spot is red. Select the chart or charts to be installed and then click the button Install charts. The charts are copied onto the hard disk.
5. The list of charts can be sorted, either ascending or descending, by each parameter. By default, charts with a valid permit are displayed on the top of the list. To perform a sort, click on the column headings. Alternative clicks will sort ascending and then descending.

→ **Note:** The user may install charts with without permits (or with invalid permits) and then install permits later. It is recommended that if sufficient disk space is available, the user installs all the charts in the trading area and only purchases the chart permits needed. Chart permits for charts not normally used or covering routes to ports of refuge or diversion can be ordered by phone, fax or email with immediate response in an emergency.

Install all charts from the CD

In order to speed up the installation procedure the system can install the full CD.

1. Click the **Install all charts from CD** button and the system will list all charts on the CD-ROM along with the parameters: Number, Scale, Permits, Status, and Name.
2. Highlight all the charts, using standard windows procedures, and then click the **Install** button.

Install charts along routes or inside a screen area

In order to reduce the number of ARCS charts installed on the hard disk, ECDIS900 can automatically select the charts on the loaded Area CD that either intersects the loaded routes or the screen area.

1. To achieve this, before activating the **Chart handling** dialog, load the routes or zoom and scroll the chart at the desired location and then click the appropriate button.
2. Click the **Install charts along the routes** button and the system will install the charts along the loaded route.
3. Click the **Install charts inside screen area** button and the system will install all permitted charts within the screen area.

Delete charts

Select a chart or charts and click the **Delete charts** button to remove the charts from the collection.

→ **Note:** When deletion is confirmed, the chart is deleted from the hard disk.

The possible errors, which may occur during the installation, are listed below. For more details about the errors, refer to "*Common errors in ARCS chart management*" on page 203.

Updates

In order to provide the navigation safety the navigator has to update chart collection with the latest corrections. HO issues the Update CDs with the Notice to Mariners corrections and the new charts editions each week.

Updates can be installed from the **Update CD** issued by UKHO.

Update by CD

The UKHO issues an Update CD with New Edition charts and Notice to Mariners corrections each week.

1. Insert the update CD ROM in the CD reader and click the **Apply update** button.

The system will automatically update the charts that have a valid permit.

→ **Note:** If there are new edition charts on the update CD for which the user has valid permits, then ECDIS offers to install the charts.

→ **Note:** Information regarding the update process is displayed in the Messages area. To check if ARCS charts are up to date, the date of the last update is displayed in the Chart handling dialog.

→ **Note:** If a large number of charts are involved the process may take some time.

Checking updated objects on the chart

To check what has been updated it is possible to switch temporarily between the display of updated chart and original chart.

1. Select the option **Display updated tiles borders** in the **Chart settings** dialog to display the borders of updated tiles.
2. Press and hold **B** to display the base chart before updating.
3. Release the key to display the updated chart.

Copy database for a multi ECDIS system

As it is for ENC charts, when ARCS chart installation and update is completed on one station, ECDIS an opportunity to copy the updated database over the network, from this station to other stations. This transfer is optimized.

Proceed as follow:

1. Install and/or update ARCS database on the planning station.
2. In the Chart handling dialog click the **Copy database** button.
3. The list of remote PC running ECDIS and connected to the LAN is listed in the open dialog.

4. Select the PC(s) on which the ARCs should be copied and click **Copy database**. On the remote station, ARCS is deactivated in case ARCS charts are used.

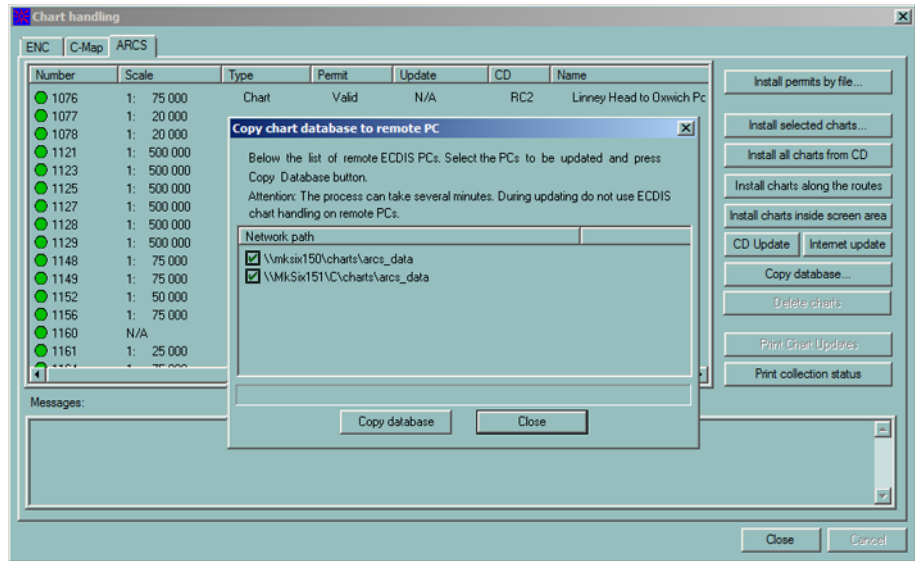

After transfer is completed, the following pop-up window is displayed:

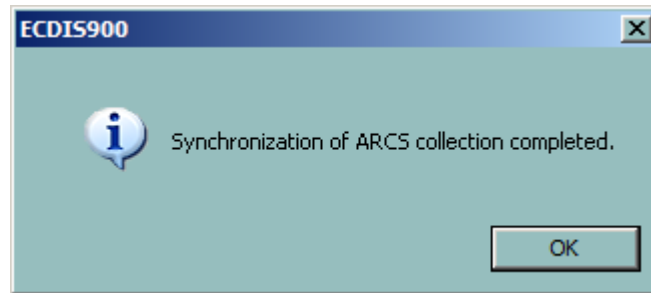

Help for paper chart correction

In order to facilitate the correction of paper charts, updated tiles (Notes to Mariners corrections) for a chosen chart can be printed on a black/white or color printer. These tiles may be stuck on the chart in the appropriate place or used to augment the relevant NM chart correction, by showing the user how the correction should be applied by hand.

1. Click the **Print Chart Updates** button to print the paper copy of the chart updated tiles.
2. Select the tiles to be printed:

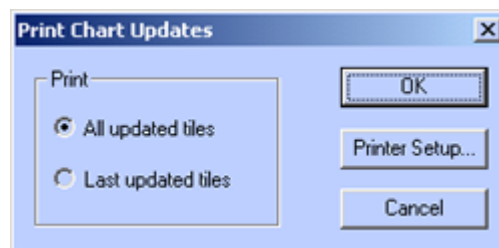

- All tiles that have been updated since the base chart was issued.
- The tiles have been updated only in the latest update procedure.

Checking the updated objects on the chart

1. Select the option **Display updated tiles borders** in Chart settings dialog to display the borders of updated tiles.
2. Press and hold **B** to display the base chart before updating.
3. Release the key to display the updated chart.

Example of printing

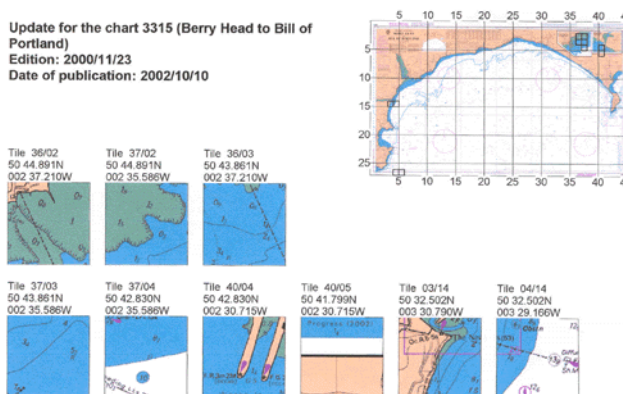

Switching to ARCS

There are several ways to switch between chart types available in ECDIS.

By selecting from the menu list

Right click on the chart, select **Other charts**, and then select ARCS.

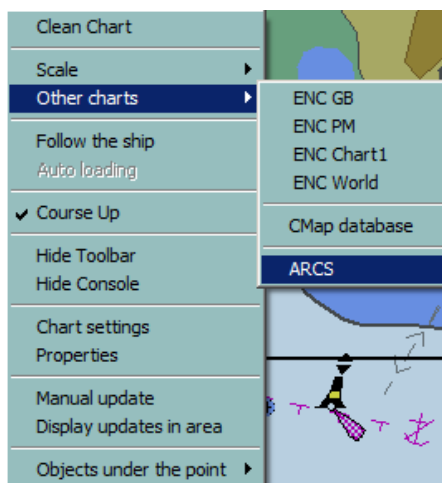

ECDIS lists all ARCS charts which are available at the current cursor position.

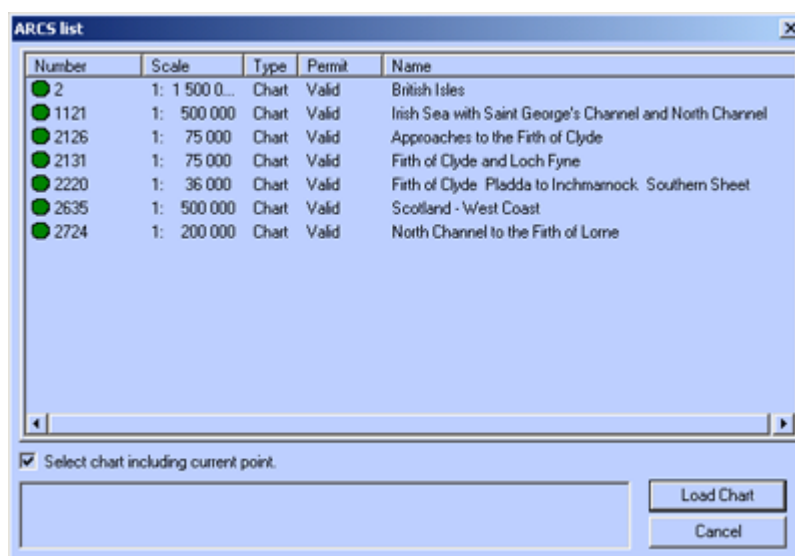

The color of the chart indicator display the chart permit status:

- **Green** – the chart permit is valid.
- **Yellow** – permit warning. The chart permit must be updated.

- **Red** – the chart permit is not valid.

There are two way to select a chart to be loaded:

- Click on the chart number and click **Load chart**.
- Double click on the chart number.

To list all available ARCS charts, toggle off the check box **Select chart including current point**.

→ **Note:** In order to facilitate the speedy selection of charts the contents of the columns in the Chart handling window may be sorted by clicking on the column heading either in ascending or descending order.

By pressing the shortcut key

Press **F9** to select another type of chart. If ARCS is selected, the chart with the best scale and centered in the middle of the current screen will be loaded automatically.

To customize the way of switching chart types, press the **Ctrl + F9** keys and get access to the set up dialog and select the chart to be used.



Switching from the Chart handling dialog

Double click on the chart number to load the ARCS chart directly from the **Chart handling** dialog.

Zooming

ARCS charts are produced in their original scale, such as 1:50,000.

The ECDIS900 will always open a chart at its surveyed scale. (Original scale).

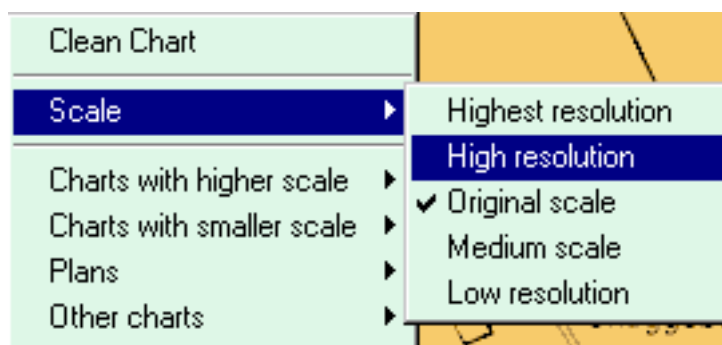

- The user can zoom out to show half the chart area on the screen (medium scale) and out again to show the whole chart in overview (low resolution).
- The user can also zoom in to display the chart at High resolution (Original scale * 2), Highest resolution (Original scale * 4).
- A warning will appear on the screen when the chart is displayed at any scale other than the original scale. **Only the original scale should be used for navigation.**

Zooming can be achieved by using the two proper toolbar buttons or short key **F1** to zoom in and **F2** to zoom out.

When operating ARCS in seamless mode, zooming is achieved by selecting a new chart from the catalog.

Choosing a new ARCS chart

By menu

To select another ARCS chart or a plan included on the current chart, move the cursor to an appropriate point on the chart and right click to bring up the menu.



Locate the cursor on either Charts with higher scale or Charts with lower scale to display the list of available charts.

ECDIS scans the chart catalogue to find all available charts containing the point where the cursor was located and displays these charts.

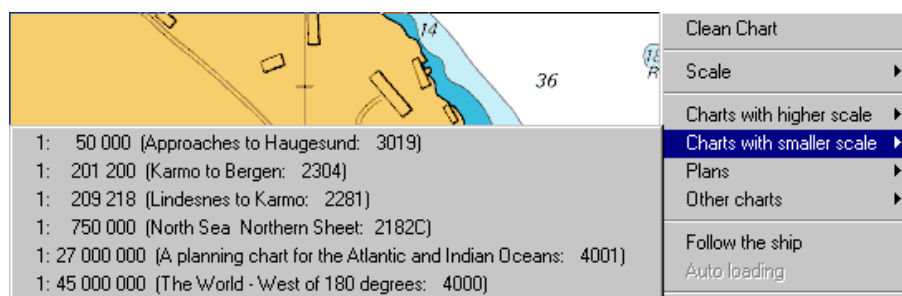

To move to a plan, click Plans and a menu of available plans relating to the current chart will appear. Select a plan and the system displays it.

By dialog

To load any other ARCS chart, not containing the point clicked on, locate the cursor anywhere on the chart, click right, locate the cursor on Other Charts, select ARCS and toggle off the check box Select chart including current point as described in the previous paragraph.

By mouse

In chart-by-chart mode, locate the cursor outside the chart and double click. ECDIS scans the catalogue to find all available charts containing the point where the cursor was located. The best scale chart is loaded and displayed.

In seamless mode double click on the inactive chart to make it active.

By hot keys or buttons

Press + or - to load the chart containing the center of the screen with higher or lower scale. Alternatively, right click on the zoom in zoom out buttons to achieve the same.

Chart settings

To change the color scheme, select the relevant item in the color menu.

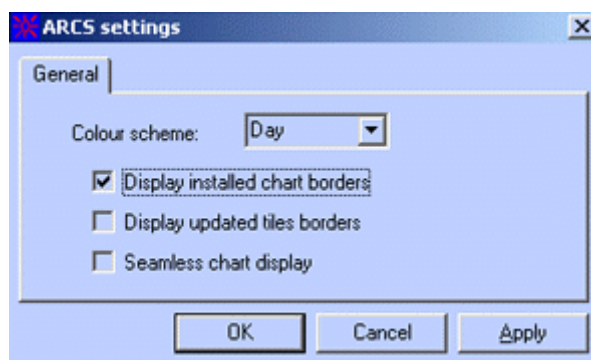

Toggle the box **Display Chart Borders** to highlight the charts available on the hard disk.

→ **Note:** Click on the borderline of the chart displays information about the chart.

Toggle the box **Display updated tiles borders** to highlight the tiles, which have been updated since the original chart was issued, check on Display updated tiles borders box.

Toggle the box **Seamless chart display** to switch on the seamless mode.

Chart properties

The **ARCS Properties** dialog provides information about the paper chart used to produce the electronic chart and also gives direct access to the notes included in the paper chart.

The properties dialog box for an ARCS chart has 2 tabs: General and Technical.

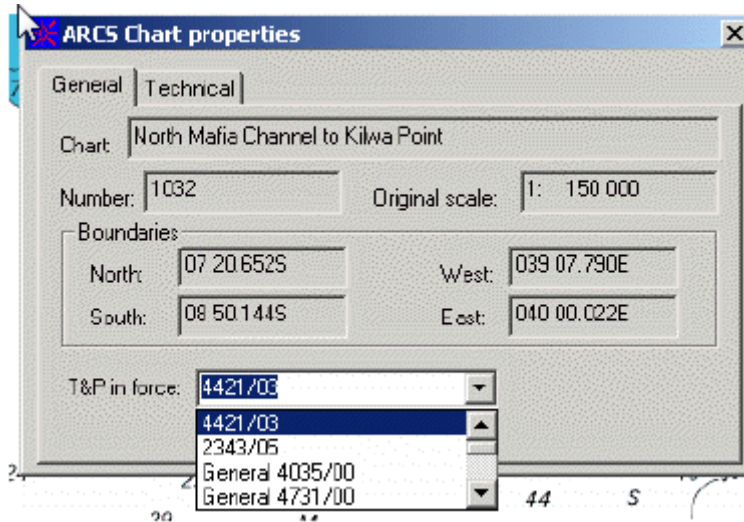

The General page displays general information about the paper chart used to compile the loaded ARCS chart.

Temporary and Preliminary Notices

The Temporary and Preliminary Notices to Mariners still in force are issued every week by the British Admiralty and are copied from the ARCS update CD to the hard disk each time ARCS charts are updated in ECDIS900.

There are two types of T&P notices:

- General, applying to an area
- Specific, linked to one specific ARCS chart.

To access, after update, the list of T&P still in force, right click on the ARCS chart and select Properties.

Select the T&P in the pop up menu located at the bottom of the window and a text window displays the text of the NtM.

Tip: For each chart, the list includes the specific notices that apply to the selected chart only plus all general T&P Notices.

The **Technical** page displays additional information about the chart and gives direct access to the chart notes.

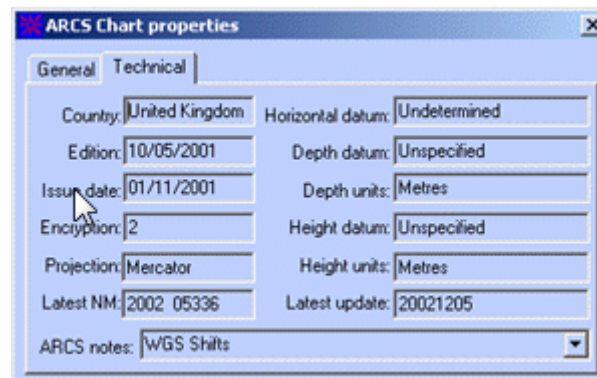

The notes belonging to the current charts are listed in the ARCS notes menu. Selecting one of the notes opens a window and shows the notes.

ARCS note							
Tidal Levels referred to Datum of Soundings							
Place	Lat N	Long W	Heights in metres above datum				Datum and Remarks
			MHWS	MHWN	MLWN	MLWS	
Mumbles	51°34'	3°58'	9.3	6.9	3.1	0.9	5.00m below Ordnance Datum (Newlyn)
Swansea	51 31	3 55	9.5	7.2	3.2	1.1	5.00m below Ordnance Datum (Newlyn)
Port Talbot	51 35	3 49	9.6	7.3	3.3	1.0	5.20m below Ordnance Datum (Newlyn)

Chart collection status

In Chart Handling dialog click the button **Print collection status** to get the current chart collection status

The two files are displayed in Notepad:

- The file **ARCS_status.txt** contains the state of the chart collection. The first part contains license details, hardware ID, User Permit and PIN code. The second part contains all installed charts description: chart number, chart title, permit diagnostic, chart original scale, source CD, update CD date, permit expiry date, permit and chart encryption number. The third part contains the all installed permits descriptions: expiry date and encryption number
- The file **ARCS_Hndl.log** records all chart handling operations: operation type, date and time of the operation, the CD identification for chart installation and updating, the chart list with successful result, the chart list with failure result.

→ **Note:** Both the above files are saved in the folder..\ECDIS_UserData\Chart_log. If a problem occurs with chart handling, send these files to the Technical Support team.

ARCS seamless mode

When ARCS seamless mode is active, ECDIS displays the current active chart together with adjacent charts (where possible) as detailed below:

Only ONE chart active at a time, the surrounding charts are shown in the same datum and at the same scale as active one but are shadowed.

→ **Note:** Whilst the surrounding charts are displayed at the same scale, this may not be their natural scale. The surrounding charts shown could be built from several different scale charts zoomed to the scale of the chart in use. In some cases the charts will not merge exactly. It should be understood that the surrounding shadowed charts are displayed for information only and should not be used for navigation.

When ECDIS needs to fill in a part of the screen with another chart, the search starts with charts of the same scale and then if no chart with the same scale is available the search is extended to charts with higher and lower scale.

The system stops searching if there is no chart available at a scale between 1/4 and 4 times the active chart scale.

The user should click on a shadowed chart to get all information about the chart and double click on a shadowed chart to activate it.

To switch on the seamless mode tick the **with ARCS** check box in the Seamless Chart display group. The default state is **Simple scale**. To get the best scaled ARCS displaying for the chart area, tick on the **Full scale**.

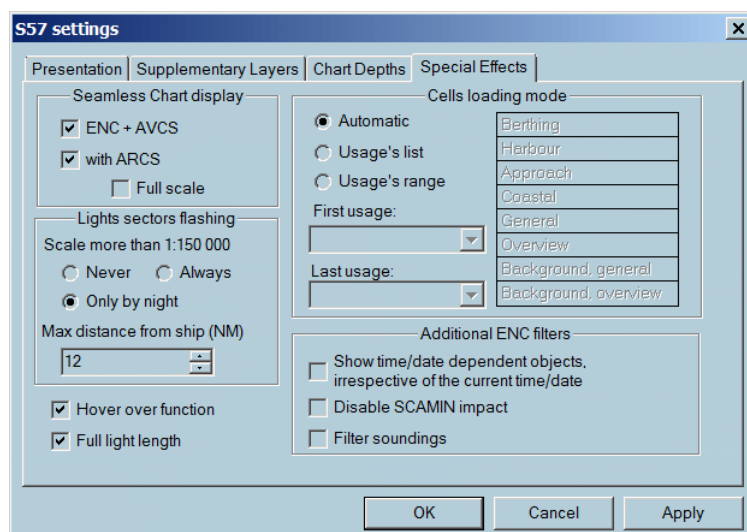

Seamless ENC/ARCS

It is possible to display the best chart coverage for the area using all available chart collections. In general the ENC, AVCS and ARCS can be displayed at the same time if **ENC +AVCS** and **with ARCS** are ticked on.

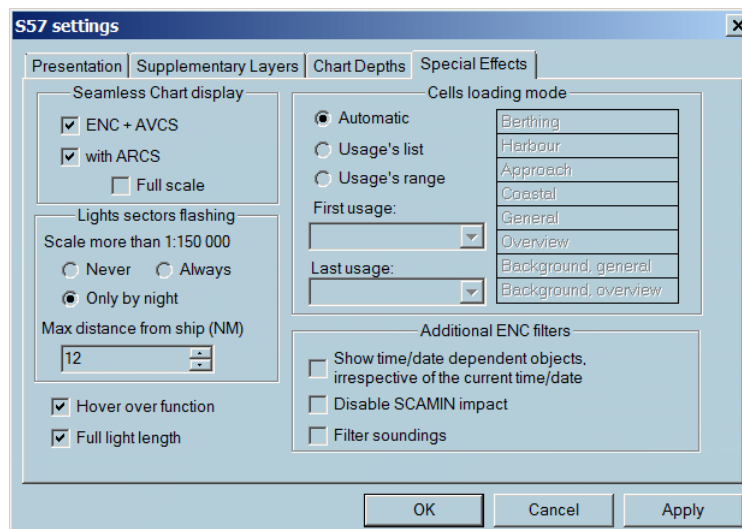

If ARCS charts are installed together with ENC the chart on the screen can be displayed in seamless mode, meaning that for the area of the screen not covered by ENC charts, ARCS charts is used to complete the pictures.

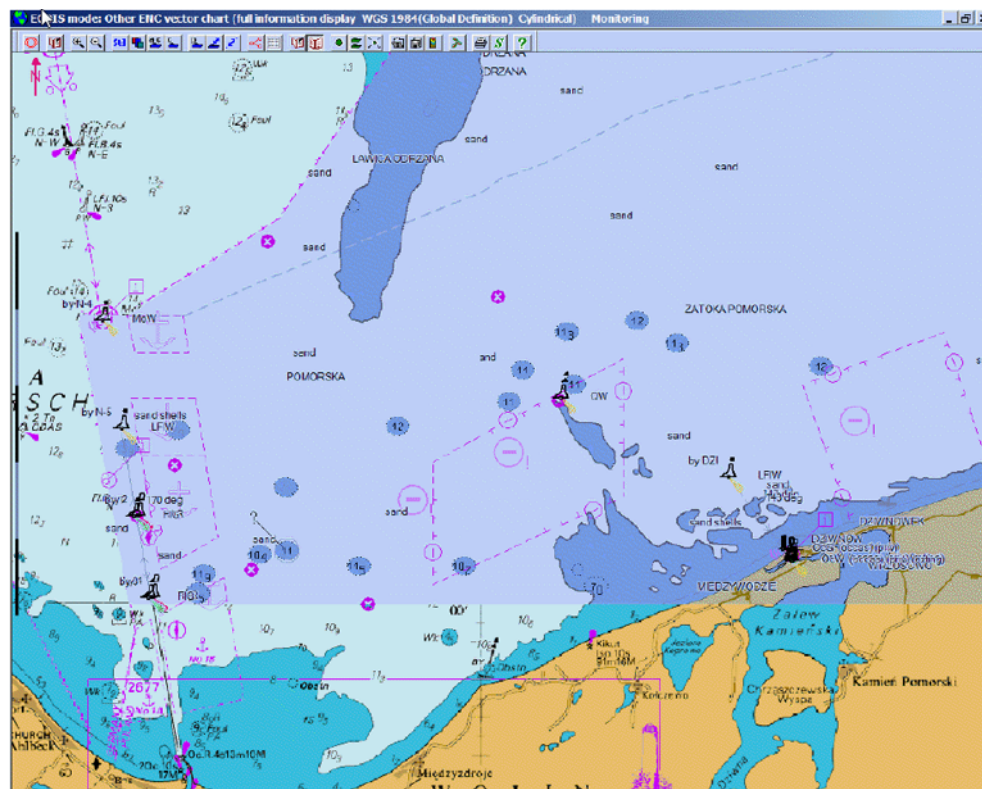

Display strategy

When ENC cells do not cover whole screen, ECDIS900 looks for an ARCS chart with the closest scale within the limits of 4 times the current scale. ARCS chart is then eventually shifted according to its datum and zoomed according to the scale in use.

If no ARCS chart is found the general ENC background chart is used to complete the coverage.

See "ARCS seamless mode" on page 94 for more details.

RCDS mode and route checking

Alarm object

The object editor (OE) is used to plot user data on the charts: simple point, lines or areas. For more details see *"Editors overview"* on page 160.

An alarm object is a geographical area, which triggers an alarm when the ship sails into it or when a planned route crosses it.

Define alarm object

Right click on the object outline, plotted on the chart, and click **Set alarm** in the pop-up menu.

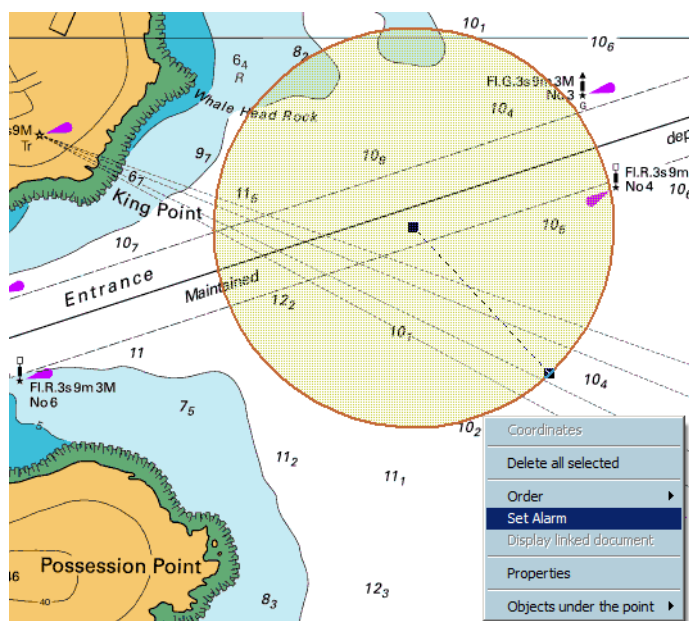

The object outline changes to red to underline that it has become an **alarm object**. The width is one pixel and the area is not filled.

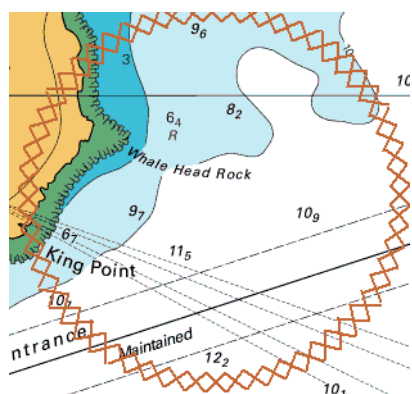

Where the alarmed object is a point, this is surrounded by a red rectangle.



Monitoring user alarm

When the ship's guard zone intercepts an alarmed object an alarm is triggered. The alarm is displayed as long as the alarmed object remains inside the ships guard zone.

→ **Note:** The guard zone depends on time and speed.

Route planning user alarm

In RCDS mode route checking against chart data is not possible, but the function **Check route** checks the planned route against user defined alarms and notifies when an alarmed area is violated.

9

Routes

A route is defined as the chosen path between two ports. A route consists of a start waypoint, an end waypoint, and a number of turning waypoints in between.

The segments between waypoints can be either **Great circle** or **Thumb line legs**.

There are several ways to create a route:

- Directly on the chart using graphic tools
- By keyboard using the route plan window
- Selecting existing waypoints.
- Importing route from different ECDIS systems
- By downloading from GPS

ECDIS provides the user with a variety of facilities for route planning and route monitoring.

Once the route is created, it can be saved on a hard disk for further use along with other routes. The route can be edited and modified, unloaded or deleted, locked and the safety of the route can be checked against dangers that may be present along the segments.

The **Route properties** dialog contains general information about the route and some options for alarm settings, turning radius, default SOG and type of passage plan.

Several planned routes can be loaded, edited and displayed at the same time but only one route can be activated and used to monitor the vessel's position.

The active route is displayed on the chart by as pecked red line.

Creating route using keyboard

1. Select the icon **Route plan** in the toolbar.
2. Enter first waypoint position in the dialog box.
3. Click the **OK and New** button and enter the second and subsequent waypoint positions.
4. Click the **OK** button to complete the route.
5. Change the name of the route in the **Route plan** dialog box.

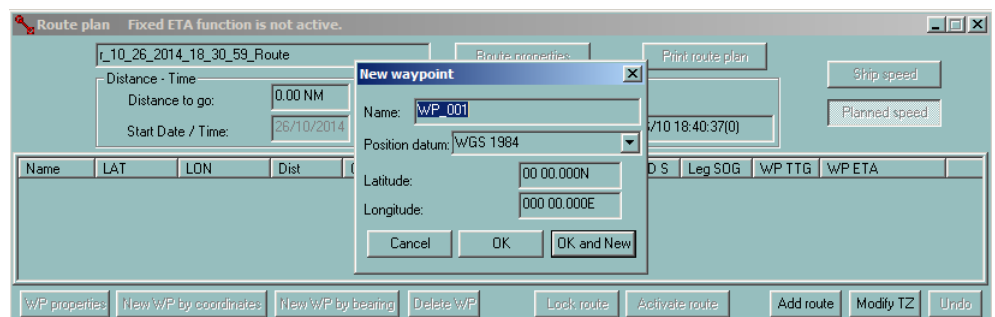

→ **Note:** If only one waypoint is entered, the route is cancelled.

ECDIS accepts the delimiter **space**, period (.) or comma (,) in the inputs.

The following strings for the latitude are compliant: 12 12.23N or 12 12 23N or 12,12,13N or 12,12 13n.

Creating route using mouse

A route can be created graphically using the **New route** tool on the toolbar or directly by keyboard entry of the waypoint coordinates in the Route plan window.



Create a route graphically

1. Click the **New route** tool on the toolbar and then click on the chart at the point where the route should begin. A waypoint (WP 001) indicated by an orange circle is placed at this point.

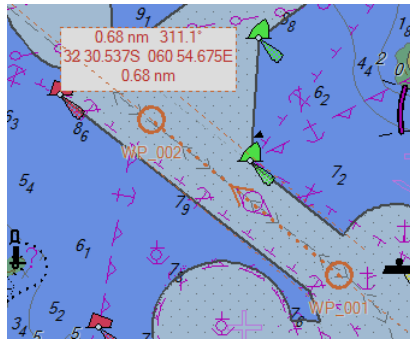

2. Double click to set the end point of the route. The **Route name** dialog appears.

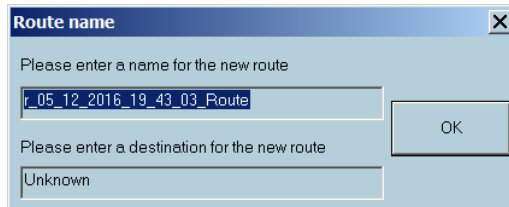

3. Type the route name and destination (or leave it as is) and click **OK**. The new route is added to the list and can be unload, download, edited, etc. at any moment.

Displayed information

1. Click on the chart at the first turning point along the route. A waypoint (WP 002) is placed at this point.
2. To set the information that should be displayed for the route, right click the route and open the Display tab

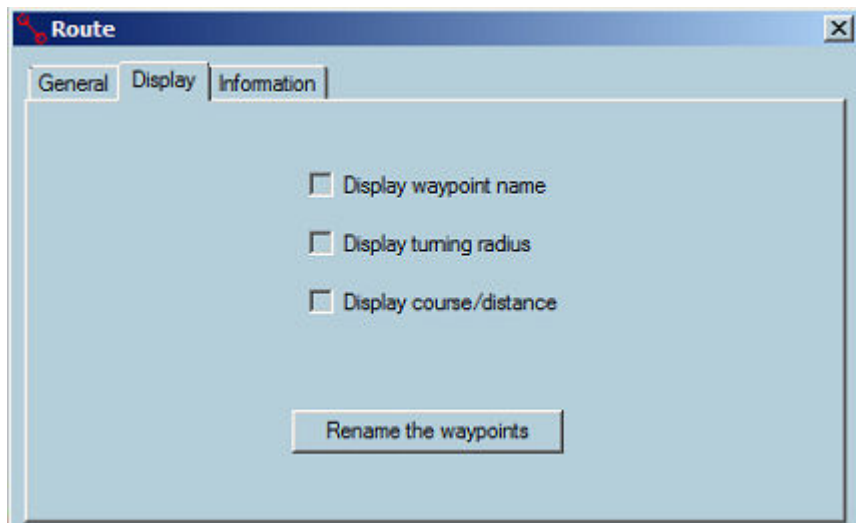

3. Then tick on the necessary parameters to display.

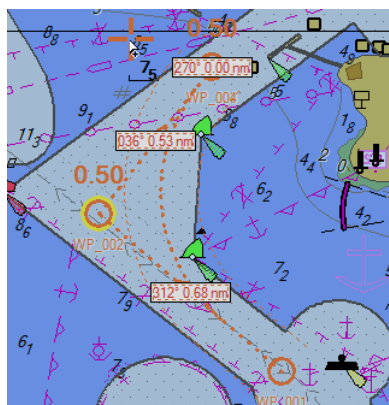

The screen covers a limited part of the chart. When a new waypoint has to be plotted outside of the screen area in view ECDIS gives the user the possibility to scroll and zoom without deactivating the New route tool:

- With ENC charts, click right button on the chart to select another scale from the drop down menu. Move the cursor outside of the chart area to scroll the chart in that direction
- With raster charts, click right button on the chart to load another chart located under the cursor. Move the cursor outside the chart area or click outside of the chart borders to load another chart located under the click.

To zoom and scroll the chart during waypoint plotting it is easier to use the short keys **F1** and **F2** to zoom in and out and the keyboard arrows to move the chart.

New waypoint and local time

ECDIS automatically calculates time zone for each waypoint. The time zone for a selected waypoint can be changed in the Waypoint properties dialog (see *"Waypoint properties"* on page 122).

Download from GPS

A route can be downloaded from a GPS. The downloading process is controlled in the **Sensor monitor** application and could be performed from the Sensor monitor as well as from the ECDIS route menu.

Different types of routes can be downloaded from the GPS:

- A complete route
- A working route that has an active waypoint as the start waypoint

The downloaded routes are automatically stored in the ECDIS route database with a default name:

- When a working route is downloaded, the route is loaded automatically in ECDIS.
- When a complete route is downloaded into the ECDIS routes database it is stored in the current route folder. The route should be given a name and then stored/used accordingly.

To use the route menu, right click on the route to be uploaded and select **Upload to GPS/Radar by NMEA** from the list.

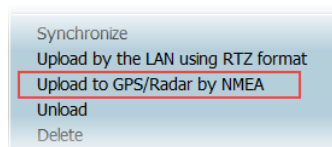

You can also open to the **Sensor Configuration** dialog and set the route download format as **NMEA Standard**.

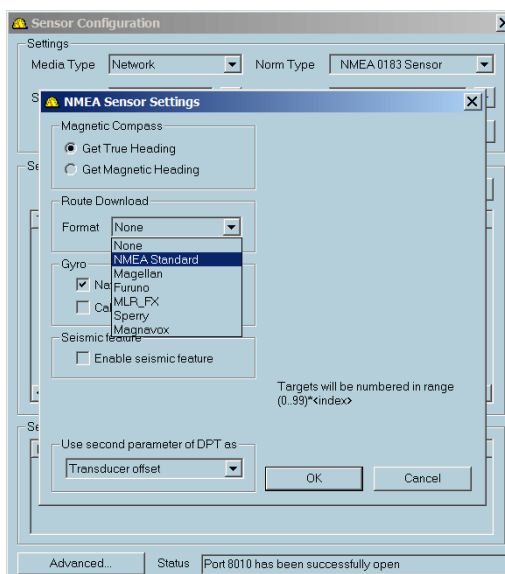

To send a route, select the Routes menu in the **Sensor monitor** toolbar and click the **Send route**.

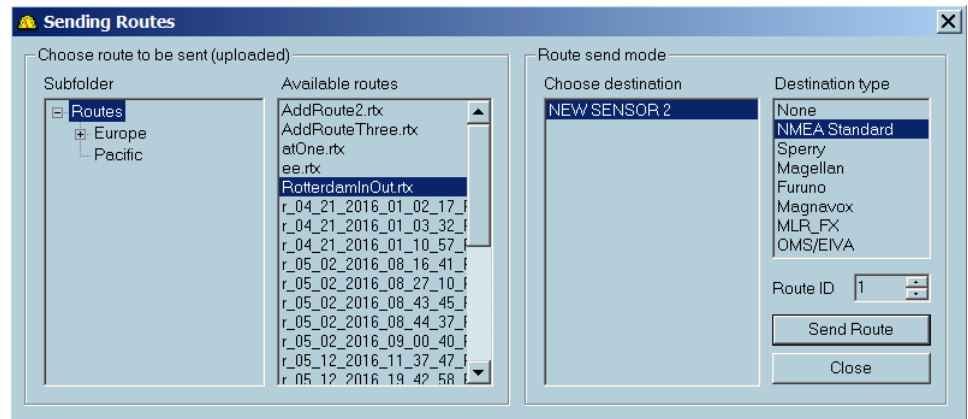

Modifying a route

A route may be modified in several ways, but cannot be modified whilst **locked** or **active**.

Move a waypoint

- To move a waypoint on the chart, locate the cursor over the waypoint, click and hold and then drag the waypoint to the new position.
- To move a waypoint via the keyboard, see "*Waypoint properties*" on page 122 or "*Route plan overview*" on page 102.

→ **Note:** In case of a mistake it is possible to go back a step. Right click on the route and select the menu item **Undo**. The waypoint is put back at the original position.

Move a selection

- To move a selection of waypoints, locate the cursor on one of the selected waypoints, click and hold and then drag the selection to the new position.

Insert a waypoint

- Right click on the route leg where the new waypoint expected.
- Select Insert new mark on the pop-up menu.

To insert a waypoint via the keyboard, see "*Route plan overview*" on page 102.

Append a waypoint

- Locate the cursor on the last leg. Right click and select **Append new waypoint** from the drop down menu. A new waypoint will be appended to the end of the route. Move the cursor to the desired position. The new segment will display the appropriate length and heading
- To stop adding new waypoints double click on the last waypoint entered.

Delete a waypoint

- Locate the cursor on a waypoint that is to be deleted, right click and select the menu item **Delete**.
- Alternatively select the waypoint by clicking once on it and press the **Delete** key.
- To delete a waypoint via the keyboard, see "*Route plan overview*" on page 102.

→ **Note: Undo** can be used to recover a route.

Split a route

- Locate the cursor on a leg, right click and select **Split** on the pop-up menu. The leg disappears and two independent routes are created. Note that the two new routes are given different names.

Reverse a route

- Locate the cursor on any route leg, right click and select **Reverse** in the pop-up menu.
- The direction of the route will now be reversed and an arrow displayed on each leg shows the direction of the route.

→ **Note:** The Reverse function also re-numbers the waypoints.

Lock/Unlock a route

- Locate the cursor on a route leg, right click right and select **Lock** on the pop-up menu.
- Locking and Unlocking the route is also possible in the "*Route plan overview*" on page 102 and in "*Route properties*" on page 101.

The route will now be protected from unauthorized alterations.

→ **Note:** Keyboard modifications in the Route plan window are also impossible when the route is locked.

Undo

- **Undo** function is applicable only for route modification. All modifications made to a route can be undone except for the function **Split the route**. Press several times to undo several modifications made to the route.
- Access **Undo** by right clicking on the route and selecting the **Undo** from the pop-up menu.

→ **Note:** When the function **Undo** is activated several times the modifications made to the selected route will be cancelled one by one.

Route properties

For route properties, locate the cursor on any leg of the route, right click and select **Properties** from the pop-up menu. Alternatively, move the mouse on top of the route and press F4 several times to access the route **Properties** dialog.

General tab

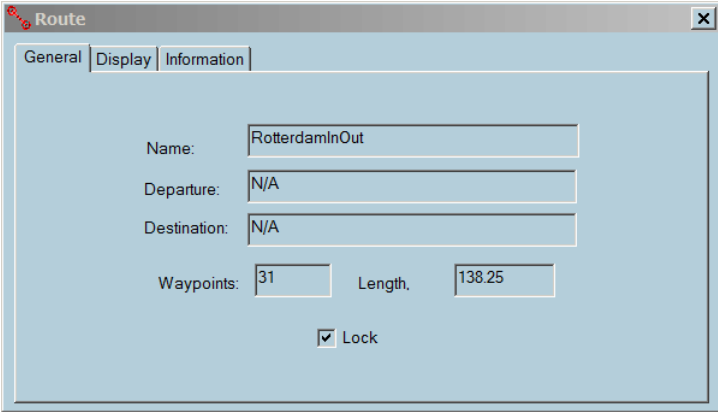

The screenshot shows a dialog box titled "Route" with a close button (X) in the top right corner. It has three tabs: "General", "Display", and "Information". The "General" tab is selected. The dialog contains the following fields and controls:

- Name: RotterdamInOut
- Departure: N/A
- Destination: N/A
- Waypoints: 31
- Length: 138.25
- Lock: Lock

- **Name:** name of the route that can be edited
- **Departure:** name of the departure port
- **Arrival:** name of the arrival port
- **Waypoints** number of waypoints
- **Length** the overall length of the route
- **Lock** toggle to lock or unlock the route. Locking the route will protect it from unauthorized editing

→ **Note:** Entering the port names is important, as this information will be transferred to the AIS for use as part of the static data broadcast by VHF

Display tab

The tab contains settings of the information displayed on the chart.

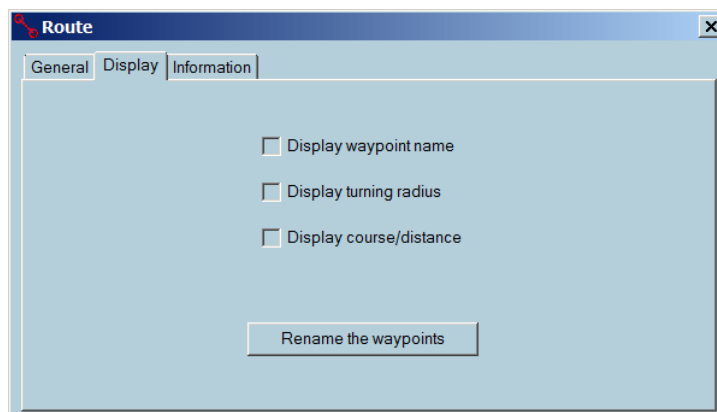

- **Display waypoint name** Toggle on/off to display the waypoint name.
 - **Display turning radius** Toggle on/off to display the turning radius along with the WP symbol.
 - **Display range/bearing** Toggle on/off to display the range and bearing on the segments.
- ➔ **Note:** In the case of the GC leg, several courses are provided at intervals along the leg to allow the Navigator to closely follow the GC leg.

Turning radius

To activate the display, toggle on the **Display turning radius** checkbox in the Display tab. It is also possible to change the turning radius of a waypoint by clicking **+** and **-** short keys when mouse cursor is on top of waypoint.

Rename the waypoints

Re-numbers the waypoints after a waypoint has been added to or deleted from the route. The **Information** tab allows entering additional information about the route.

Information tab

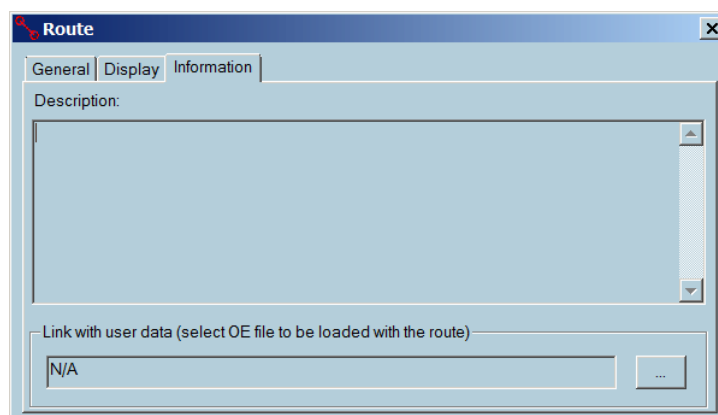

Link with OE file

Create a file with Object editor tools including points, line, areas, or text. Link the file with the current route.

Loading a route

When the route is loaded and activated the OE file linked with the route is automatically displayed.

When the OE file is loaded with the route, all objects of the file are defined as user alerts. For example, if the ship enters an area, defined in the OE file loaded with the route, an entering zone alarm is triggered.

See more details in *"Properties of OE objects"* on page 168.

Unloading the route

The OE file is automatically unloaded when the route is unloaded.

Route plan overview

Right click on the route leg and select **Route plan** from the list.

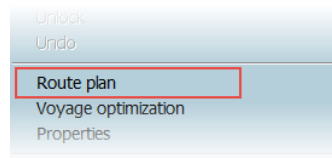

Alternatively, press **F6** to get the route plan. If several routes are loaded, press **F6** several times until the **Route plan** dialog for the selected route is displayed.

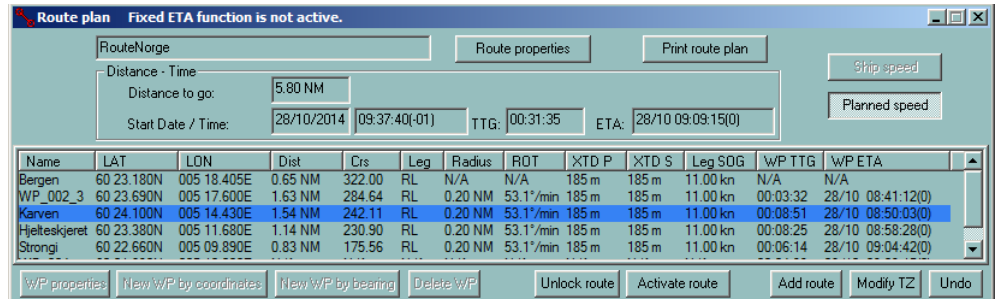

The **Route plan** dialog box displays information concerning the waypoints, the legs, and the route. You can edit waypoints or route information, simulate the voyage or print a document. Double clicking on a waypoint name centers the chart on the selected waypoint. Right clicking on the waypoint name allows you to move the selected waypoint in the list or to set the waypoint as the pilot waypoint. You may change the waypoint's position, type of leg, XTD Port, XTD Starboard, or the ROT.

Other values like the distance to go, TTG, range and bearing are calculated and therefore not allowed to modify.

There are three ways to modify values:

- Clicking the **Waypoint properties** button to access editing dialog.
- Clicking on a value in the list and edit this value in the dialog.
- Clicking the column title of an editable value to change all values like the SOG, turning radius, XTD in the column at the same time.

→ **Note:** When the route is locked the buttons are disabled and fields cannot be edited. Unlock the route to make the components editable.

→ **Note:** Modifications carried out in the route plan dialog box are immediately displayed on the chart and the changes can be graphically checked

To select multiple waypoints, press and hold the **Ctrl** key and click on the desired waypoint. When several waypoints are selected, the following values can be modified for all selected points in one action:

- Radius
- ROT
- XTD
- SOG

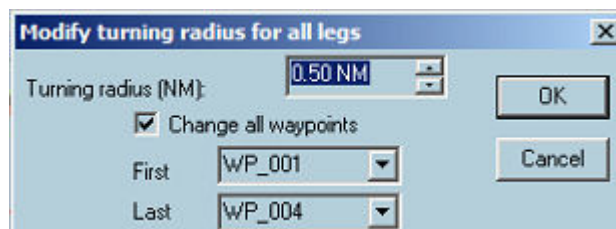

Change type of leg

A leg is defined by two waypoints and the leg type is stored in the properties of the first waypoint.

Click on the leg type value RL (Rhumb Line) to change to GC (Great Circle) and vice versa.

Set a new turning radius

Click on the Turning Radius for the chosen leg and enter the new value in the pop-up dialog box

The Turning Radius value may also be entered in the Waypoint Properties dialog.

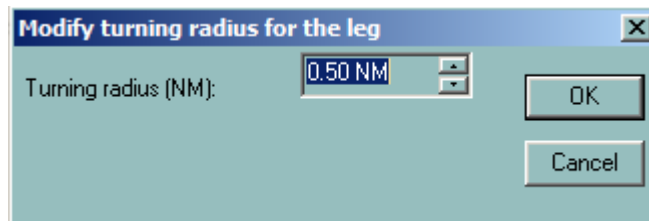

→ **Note:** When the Turning radius is changed, the ROT is also changed according to the selected speed and vice versa.

→ **Note:** To change the turning radius value for all legs, click in the title Radius.

Set XTD

Use the same procedure as for **Set new turning radius**.

By default, the XTD value is entered in the Option dialog panel Route.

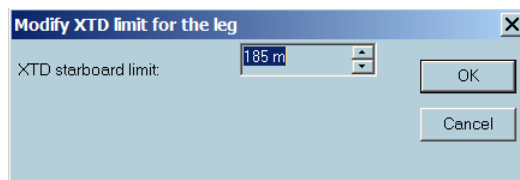

→ **Note:** Click in the title XTD to modify XTD for all legs.

Set SOG

Use the same procedure as for Set new turning radius.

By default the SOG value is entered in the Route Properties dialog box.

→ **Note:** Click the title SOG to modify SOG for all legs.

Set ETA

Click on the ETA value of the leg and enter a new ETA. Then the leg SOG will be re-calculated.

→ **Note:** Click on the title ETA to enter a new ETA for the last waypoint. In this case the SOG will be recalculated and constant for all legs.

Print

1. Click the **Print route plan** button
2. The route plan is transferred to the text file similar below:

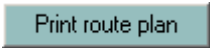

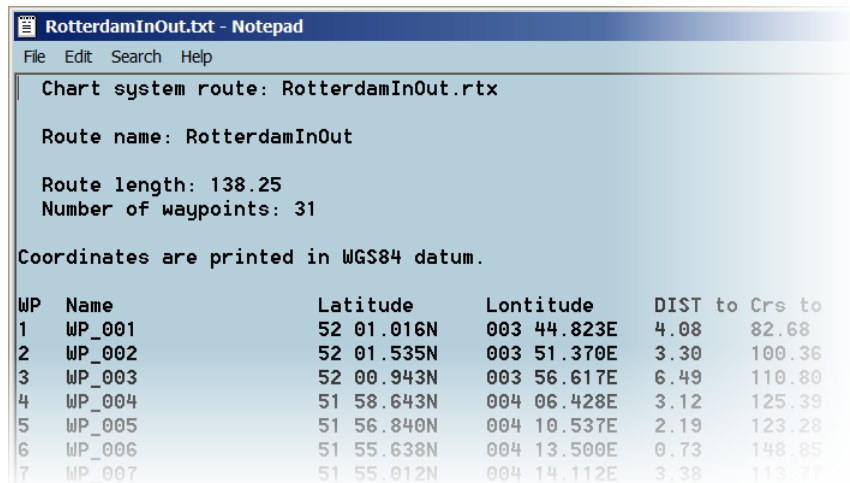

It is possible to modify the text file before printing.

→ **Note:** The text file can be stored in a local or shared drive/folders for future reference.

Modify Time Zone

1. To modify the time zone to the selected waypoint, click the **Modify TZ** button
2. Set the value and click the **OK** button to save.

Modify TZ

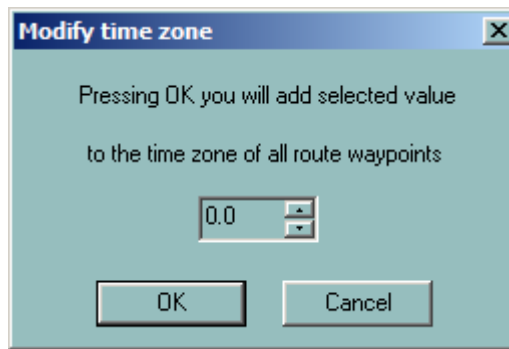

Add a route

1. Click the **Add route** button
2. Select the route and click **OK**.

Add route

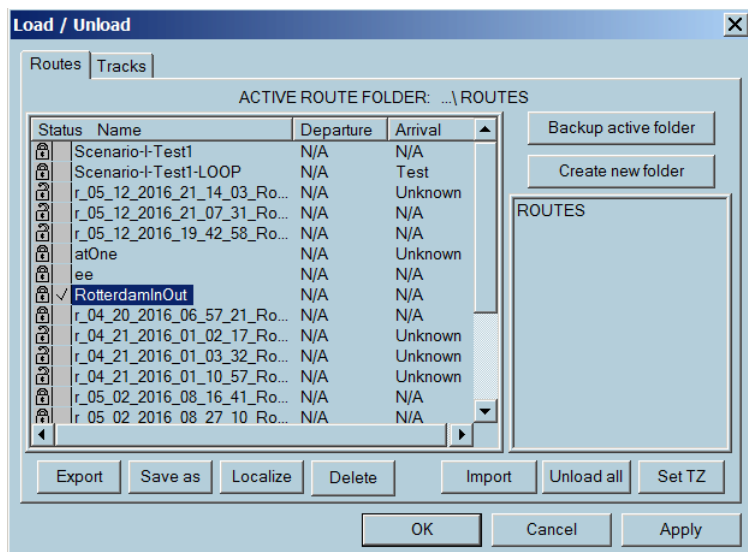

The selected route will be added to the current route.

→ **Note:** It is not possible to select multiple routes in this operation.

Set Date/Time

To change the date and time, adjust by typing in the correct date and time in the correct input field.



Parallel index

To create a route parallel index, right click on the route and select the **Parallel index** from the list.

It's possible to draw line parallel to the selected route leg. Distance from the leg (in NM) and time of creation are clearly displayed in the label of the line. This line is part of navigational editor and therefore it is possible to edit the change the position and length at any time.

Parallel index is recorded in the logbook.

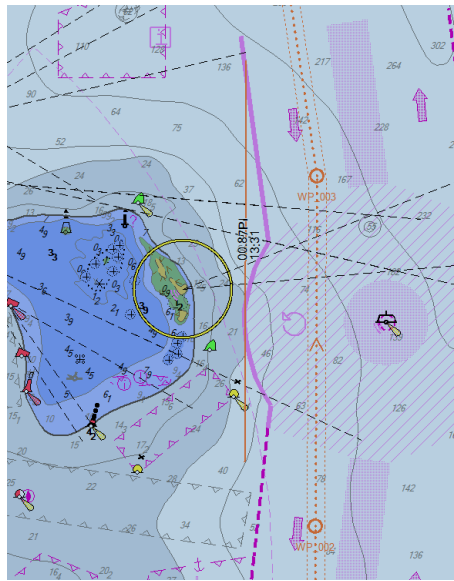

Load, unload, and delete route functions

To load/unload routes or tracks click on the **Load/Unload objects** button in the toolbar.

Click on the **Routes** tab to display the list of routes.



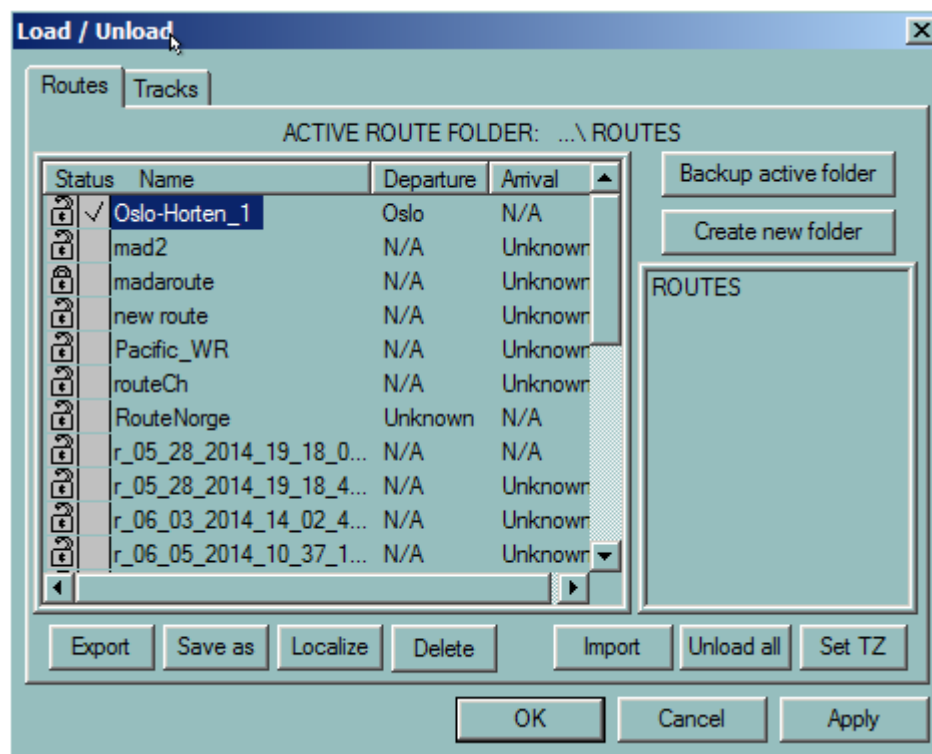

The list of route names may be sorted in ascending or descending order by clicking on the column headings.

Use the **Create new folder** button to save the routes in a specified folder.

Use the **Backup active folder** button to save a back up data of your routes into a specified backup location.

You load a route by ticking on the checkbox beside the route name and clicking the **OK** or **Apply** button.

You unload the route by ticking off the checkbox beside the route name and clicking the **OK** or **Apply** button. Select the **Unload All** button to unload all routes from the chart.

Use the **Save as** button to save the selected route into a different filename or location.

Use the **Export** button to download the selected route.

Use the **Import** button to load an existing route from a different folder location.

Use the **Delete** button to remove the selected route from the list.

Use the **Localize** button to center the chart on the selected route.

You lock/unlock the selected route by clicking on/off the **Padlock** icon beside the route name.

→ **Note:** Locked routes cannot be deleted.

Synchronize a route between workstations

To synchronize an ECDIS workstation into another, right click on the route and select **Synchronize** from the list.

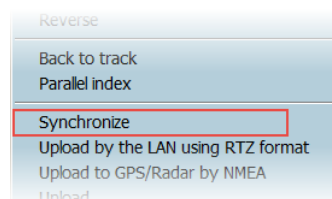

The dialog similar below with the list of available ECDIS workstations is displayed:

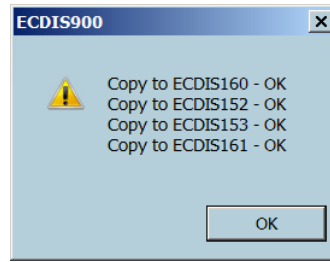

Click the **OK** button.

→ **Note:** Route plans can be downloaded from any workstations once synchronized.

Upload routes by LAN

The .rtz format is used for import and export of routes. The route can be stored on a local or shared drive/folders.

To upload the selected route by LAN, right click on the route and select the **Upload by the LAN using RTZ format** from the list.

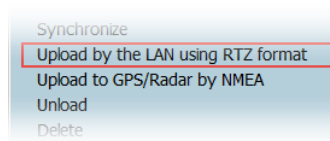

The route is broadcasted to all stations of the system.

→ **Note:** The route reception must be confirmed on each ECDIS workstation.

Check a route

Use the **Check route** function to check the routes against dangers of the chart and against user defined objects when vector charts are in use.

When raster charts are used, only user defined objects are being checked

To activate the **Check route** function, locate the cursor on a route leg, right click and select **Check route** from the list.

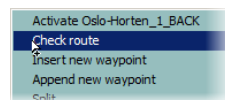

The function checks the route against all charted dangers that may be present along the route legs. It scans the vector database including manually updated objects and user data objects loaded on the chart and calculates the dangers inside the safety passage defined by the XTD values and according to the settings: safety contour and height. A list of dangers is then displayed in the window.

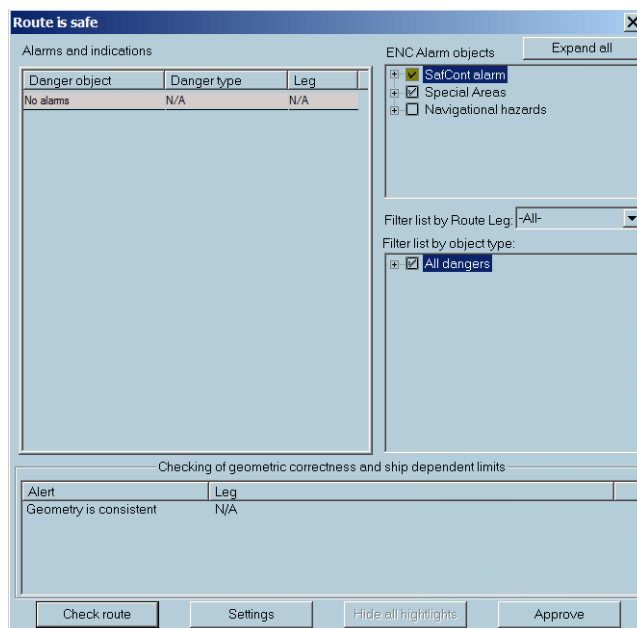

The top right frame contains two lists of ENC alarm objects. The **Safety contour alarms** are always on. Configure the **Special area alarms** list to set warnings as alarms if it is necessary. The second frame on the right side of the window contains entire list of danger object types and the user can filter the object type to alert.

Route can be checked leg by leg. You can select the leg for checking in the **Filter list by route leg** drop-down list.

The bottom frame contains results of the route geometry checking.

To change the Guard zone settings, click the **Settings** button.

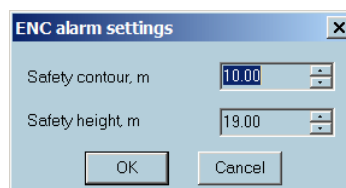

Adjust the settings in the Guard zone window as required.

In case the checking result contains one or more danger objects the Guard zone settings are displayed in the caption of the window and the objects are listed in the left frame.

An alarm is red highlighted and a warning is yellow highlighted.

→ **Note:** Selected objects from the **Filter list** are considered as warnings.

Additional information about the danger displayed in the tooltip after the item is hovered by the cursor.

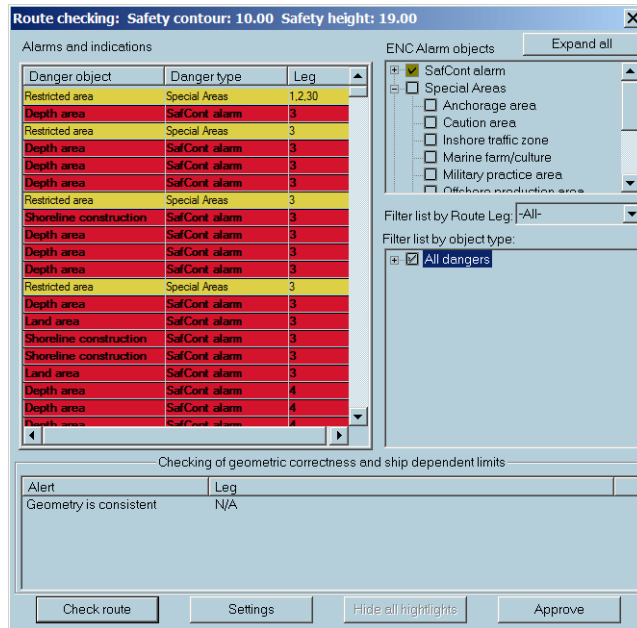

Is Special areas is not ticked on, the caution alert is generated in the alert list and displayed on the Alert panel. Otherwise, the Special area alert is considered as a warning. The Navigational hazards are considered as a caution.

- **Note:** To approve danger, click on the danger in the list. The approved **alarm** changes the highlight color to green, an approved **warning** changes the color to gray. Clicking on an item makes the chart centered on the selected danger. An intersection of danger with the route safety corridor is highlighted too.
- **Note:** It is possible to approve the route without approving displayed dangers. The warning message is displayed in this case.

Danger object	Danger type	Leg
Restricted area	Special Areas	1,2,30
Depth area	SafCont alarm	3
Restricted area	Special Areas	3
Depth area	SafCont alarm	3
Depth area	SafCont alarm	3

- **Note:** It is recommended to check all dangers and edit the route before approval.

Danger highlighting

The system highlights dangers when the Check route function is performed. All dangers listed in the Check route dialog are highlighted along the route.

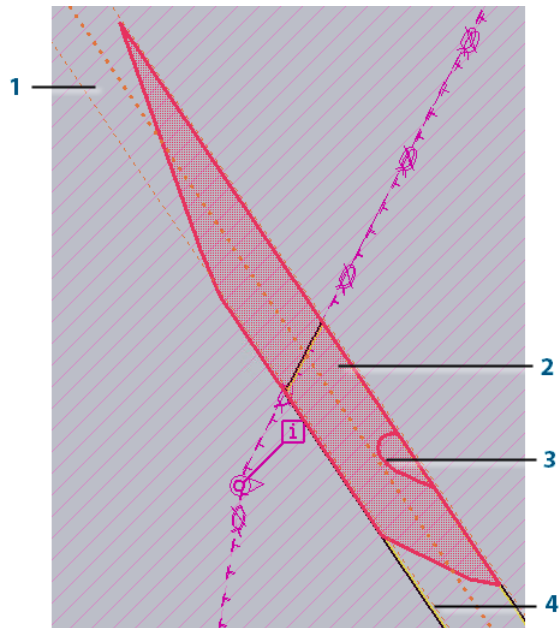

- 1 Route without dangers
- 2 Danger area
- 3 Danger contour
- 4 Warning contour

Route options

The user sets and stores the default values for route and waypoint parameters in the **Route options** dialog box.

To view or effect changes to the route parameters click on the Options icon on the main toolbar and then select the **Route** tab.

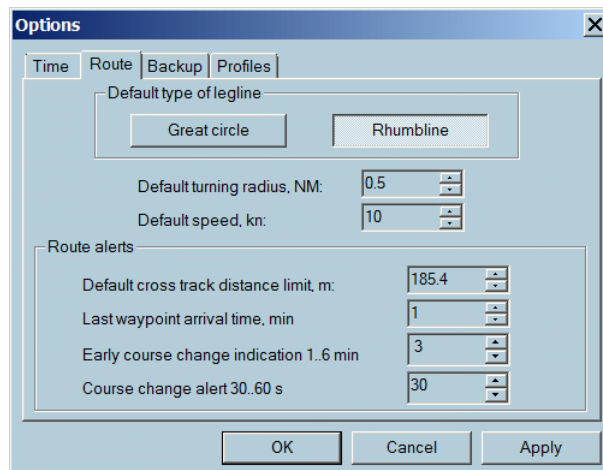

- **Default type of legline:** Select either **Great circle** or **Rhumbline**.
- **Turning radius (NM):** default value for route creation.
- **Speed (kn):** default speed value for route creation.

Route alerts:

- **Cross Track error (m):** Toggle up or down to set the appropriate value or input it via the keyboard.
- **Waypoint arrival distance (NM):** Toggle up or down for the appropriate value or input it via the keyboard.

- **Early CC indication (min):** when approaching the active waypoint, an indication is triggered when the ship arrives at between 1 and 6 minutes from the waypoint (at the current speed). The time is set by the user.
- **CC indication(s):** The second indication is given between 30 and 60 seconds before arrival to the active waypoint WOP.

For a complete description of waypoint arrival criteria see *"Waypoint arrival warnings and alarms"* on page 124.

Route status report

You can get status report for ENC charts under the selected route. See *"Charts under the route status report"* on page 76 for details.

Route import and export functions

Route format

A route can be saved in the most common **.txt** format.

When a route is saved as a text file, the following standard format is used:

- Name of the route
- Name of the waypoint:
 - Latitude
 - Longitude
 - Planned speed for the leg
 - Type of the leg (1 Rhumb line, 2 Great circles)

Importing route formats

ECDIS900 can import routes with different route formats:

- XML format (with route file extensions .rtz)
- ECDIS900 format (with route file extensions .rtx)

The can also import other route formats from the previous ECDIS900 version (with route file extensions .rtu) and other manufacturers' routes like Sperry, MaxSea, Transas, and others.

→ **Note:** Routes are stored in ECDIS using WGS84 datum. When a route is imported, it is important to select the datum that has been used for the route creation so that the ECDIS is able to calculate the exact coordinates of the waypoints. If the datum is not correctly selected, the waypoints are shifted.

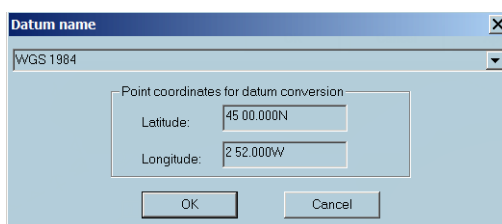

New route

Click on the **New Route** icon to create a new route and to plot waypoints on the chart with the mouse.



The waypoints can be plotted on the chart with the mouse or entered by keyboard in the route plan window which is activated by clicking the button **Route Plan**.

For a detailed overview of the route management, see *"Routes"* on page 97.

Route plan

Click on the **Active route plan** button to display the Route planning window of the active route.



→ **Note:** If an uploaded route is not active, the route plan is opened in the **Create new route** mode.

Short key

Press the **F6** key to access to the route plan of loaded routes. Press several times to change the selected route.

For a detailed overview of the Route planning window, see "*Route*" on page 97.

Route monitoring

A standard ECDIS installation includes a Monitoring workstation located on the ships bridge and a Planning station on the chart table.

→ **Note:** The ECDIS software can run in either Monitoring mode or in Planning mode. The current mode is displayed in the title bar in the caption of the chart window. The route activation is available in the **Monitoring mode** only.

The route activation is disabled on Planning station. To switch a workstation from Monitoring mode to Planning or vice versa, right double click in the title bar of the chart window and activate the menu Set as Planning station or Set as Monitoring station.

Activating a route

When activating a route the user designates it as the route to be navigated. The ECDIS changes the route legs to pecked lines, highlights the next waypoint and switches the monitoring mode on.

To activate a route and switch on the route monitoring function on the Monitoring workstation:

- Load the route to be activated.
- Click right button on one of the legs of the route.
- Select **Activate route_name** from the pop-up menu.

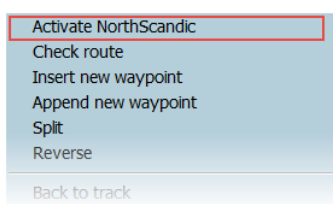

Alternatively, a route can be activated from the Route plan window with the button

Activate route.

→ **Note:** When an OE file is linked with the route the file is automatically loaded and all alerts of the file activated.

Display

Only one route can be active at any time. An active route is displayed differently than other routes on the chart inasmuch as the segment path is drawn dotted and the active waypoint flashes making it more prominent on the screen.

Active route and planning station

When a route is activated on the Monitoring station all Planning stations connected to the LAN receive and display the same active route. Then all ECDIS workstations display the same active route but only the Monitoring workstation can actively handle it.

A new route activation

A new route can be activated even if another route is already active. When the new route is activated the previous active route will be de-activated.

Active route and Planning station

When a route is activated on the Monitoring station, all Planning stations connected to the LAN receive and display the same active route.

Route geometry checking

→ **Note:** To be activated, the route has to be geometrically correct.

The geometrically correct route has leg length that is sufficient to make two neighbor turns with no intersections. Turn radius value is defined in the Route tab of the Options dialog. Turns are displayed for all Waypoints, except for the first and the last ones.

Acceptable range for Turning radius can be modified in **TCS options** dialog. To open the dialog, right click on the Autopilot console and select TCS options. Set Maximum radius and Minimum radius values for a turning radius.



Rate of Turn (ROT) can be also changed manually in Route planning. See *"Set a new turning radius"* on page 104 for details.

Route checking in ENC chart mode

When activated, the route is automatically checked against the dangers of the ENC database including manually updated objects and user defined dangers. If any leg is dangerous, the dangers are listed in the Route checking window and highlighted on the chart.

Route monitoring

When a route is activated, route monitoring is automatically switched on. The ECDIS900 continuously calculates and displays data about the vessel's approach to the active waypoint (see *"Active waypoint information"* on page 120), ETA to the selected waypoint (see *"Waypoint ETA information"* on page 123), and, on request, the calculated speed to sail to reach a particular waypoint at the fixed ETA (see *"Fixed ETA function"* on page 123).

The ECDIS triggers alerts for waypoint arrival or XTD out of limits (see *"Alerts"* on page 114).

→ **Note:** The Wheel over Point (WOP) is calculated according to the turning radius value entered by the navigator. It is extremely important to enter this value during route planning.

To select an active waypoint manually, right click on the chosen waypoint on the chart or select the waypoint in the route monitoring plan.

Alerts

When the XTD or Waypoint arrival alerts are active the ECDIS900 will trigger an alert each time the alert parameters are met. A route alert can be classified as alarm or as indication. The type depends on user settings.

Setting route alerts parameters

- In the ship properties dialog under the **Alarms** tab tick on the boxes to activate the XTD alarm (see *"Configuring alerts"* on page 41).
- In the waypoint properties dialog set the appropriate XTD parameters (see *"Waypoint properties"* on page 122).
- In the Route tab of the Options dialog, the waypoint arrival indication and distance values are preset (see *"Route options"* on page 111).

Route monitoring plan

When the active route is locked it cannot be edited. You can only change the planned speed for the remaining legs.

The active waypoint line is displayed in red, the selected waypoint line in blue.

To modify the route it is necessary to deactivate the route and then unlock it before editing.

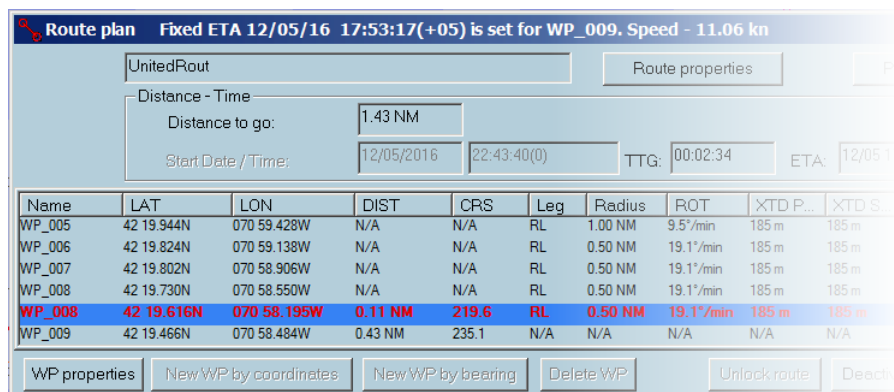

Distance to go

The **Distance to go** in the console is measured from the ship to the last waypoint.

ETA

The ETA shown in the console area and in the Route plan dialog box is calculated using either the current (actual) Ship speed for the remaining distance or the Ship speed for the current leg and the Planned speed (inserted by the user in the Leg SOG column) for the remaining legs.

To insert the planned speed for each remaining leg, left click on the relevant Leg SOG cell and set the SOG value.

When the **Ship speed** is toggled on in the Route plan dialog box, the ETA calculation is made using the ship speed to the final waypoint.

When the button is toggled to **Planned speed**, the ETA calculation is made using the ship speed for the current leg and the planned speed value for each remaining legs.

→ **Note:** In the picture above, planned speed values are used to calculate ETA.

Waypoint ETA

The console panel **WP ETA** displays the ETA at the selected waypoint.

- Select the appropriate waypoint number.
- Toggle on Planned speed or Ship speed for the calculation of ETA.

Target linked to a route

One AIS target can be linked to a route.

1. Right click on the target to open AIS target menu.
2. Choose the option **Link with route**.

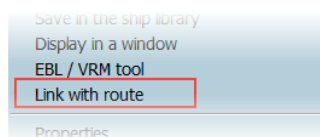

3. Select the route. A yellow square point out the target and route is displayed in green.



Target is linked to the route. The route plan can be displayed as it is for the own ship. The same values are given, Bearing, Range.... TTG and ETA are indicated for planned speed.

The route is unlinked by **Deactivate linked route** of the Target menu or when target arrived to the last waypoint.

→ **Note:** Route plan cannot be used as activated route for Own ship.

3 windows are dedicated to target route information.

Target consoles

Three consoles display target data.

- Target (when target selected)
- Target waypoint
- Target waypoint ETA (when selected target linked to a route)

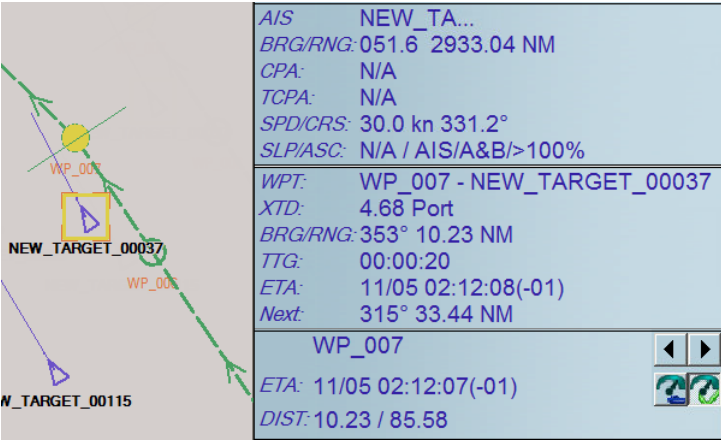

The screenshot shows a map on the left with waypoints WP_007, NEW_TARGET_00037, and WP_002. A data panel on the right displays the following information:

<i>AIS</i>	NEW_TA...
<i>BRG/RNG</i>	051.6 2933.04 NM
<i>CPA</i>	N/A
<i>TCPA</i>	N/A
<i>SPD/CRS</i>	30.0 kn 331.2°
<i>SLP/ASC</i>	N/A / AIS/A&B/>100%
<i>WPT</i>	WP_007 - NEW_TARGET_00037
<i>XTD</i>	4.68 Port
<i>BRG/RNG</i>	353° 10.23 NM
<i>TTG</i>	00:00:20
<i>ETA</i>	11/05 02:12:08(-01)
<i>Next</i>	315° 33.44 NM
WP_007	
<i>ETA</i>	11/05 02:12:07(-01)
<i>DIST</i>	10.23 / 85.58

Target

(VTC STAR selected)

Target-Waypoint

(Activated WP_002)

Target-Waypoint ETA

(Selected WP_003)

Route planning and turning radius

The turning radius of a ship depends upon design, loading and environmental characteristics. The user must carefully select the appropriate turning radius taking into account these parameters.

The ECDIS can be linked to the ships autopilot to automatically alter course at each waypoint. The amount of helm ordered by the ECDIS900 will vary according to turning parameters set in the system.

The helm ordered and rate of turn value NEVER exceed the limits defined by the user. To complete a prescribed turn at a waypoint it is essential for the turning radius to be set into the system accurately.

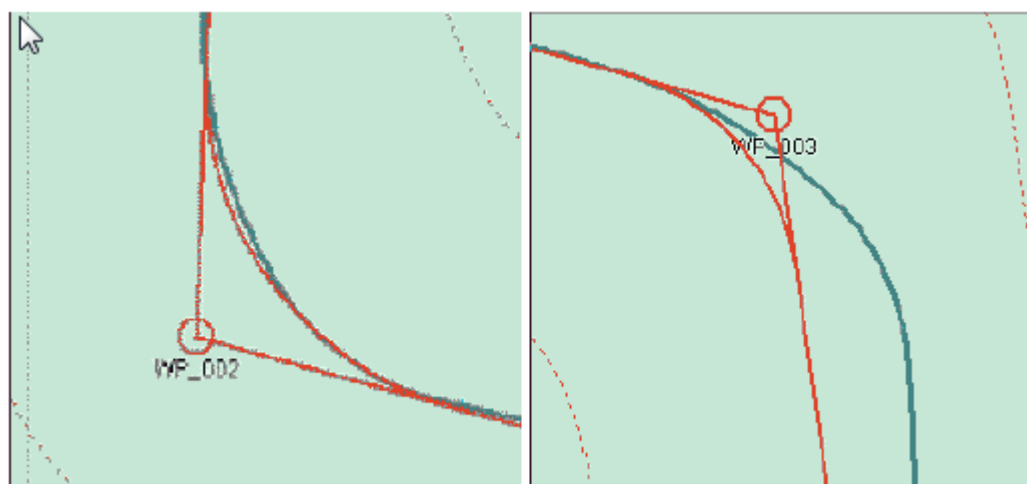

→ **Note:** Picture on the left shows that the turning radius is good and ECDIS900 is able to follow the planned route during the turn.

→ **Note:** Picture on the right shows that the turning Radius is not correct and ECDIS900 is not able to follow the planned route.

Autopilot and trackpilot

The data sentences to be sent to the Autopilot and trackpilot are selected in the application Sensor Monitor.

When a route is active and the option Track steering or Autopilot is activated, the ECDIS regularly sends the selected sentences to the autopilot or trackpilot.

Checkout before the TCS activation:

- valid GPS, GYRO and LOG .
- difference between HDG and active leg course .
- ship should be within XTD limit and some distance in front of wheel over line .

Trackpilot option

Right click in the Autopilot console and select the item TCS options to display the dialog (see "TCS options" on page 117).

→ **Note:** To make the Autopilot console visible, tick on Autopilot in the Console tab of the Options dialog.

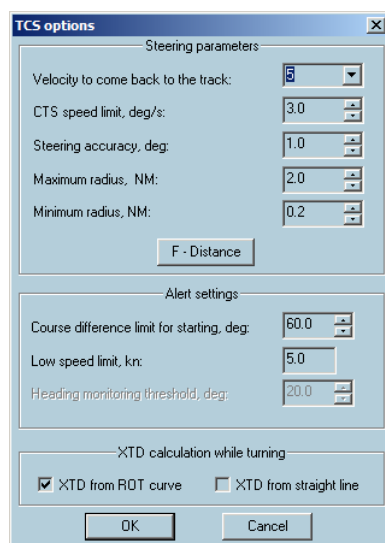

TCS options

Steering parameters

Velocity to come back to the track

The parameter controls how fast the ship comes back to the track. The yellow point displayed on the route is the point the ship tries to reach. Bigger is the value, faster the ship will try to get back on the route but more intensive will be the rudder usage when the ship is sailing along the track.

CTS speed limit

It is the maximum of course change per second that the TCS can accept. Is not used anymore for TCS, but can be used as reference to control ROT limit and in simulation mode.

Steering accuracy, degr

The parameter has influence on the rudder usage. The meaning is the minimum deviation from the current leg course, which is ignored . Used only on straight part of the route.

Maximum radius, NM

It is the limit for maximum turning radius that used to check planned route against the ship dynamics

Minimum radius, NM

It is the limit for maximum turning radius that used to check planned route against the ship dynamics

F-Distance

Click the **F-Distance** button to set or adjust distances to start turn for the ship. The **Distance to start turn** table of distances dependent from the ship speed, which is used to calculate WOL position. Parameter is very important to setup properly to reach precise steering.

Alert settings

Course difference limit for starting, degree

It is the limit of difference between ship heading and active leg course which makes impossible to activate TCS. Use the **Back on track** function to build temporary route, which makes possible to join the planned route using TCS function.

Low speed limit, kn

The parameter is used to trigger alarm in case TCS is active and vessel speed is less then specified threshold. Meaning that autopilot is not able to provide proper steering quality under specified conditions.

Heading monitoring threshold, degr

The parameter is used to monitor two GYRO values. Alert is triggered in case the difference exceeds the specified threshold.

Position monitoring threshold, m

The parameter is used to monitor two GPS positions. Alert is triggered in case the difference exceeds the specified threshold.

XTD calculation while turning

- Select **XTD from ROT curve** when using (new) autopilot type which needs XTD calculation during turning not from turning curve.
- Select **XTD from straight line**, using (old) autopilot type which needs calculation from straight line.

F-Distance

Use the **F-distance** button to display the **Distance to start turn** dialog and modify the settings of turning distances accordingly:

Please fill in the table of distances the ship makes from the time you activate a turn til time the ship actually starts to turn. This distance is used in Active Leg tool for precise navigation in narrow waters and depend from the ship speed.

Select loading profile: **Ballast**

	Ballast	Medium	Loaded	
Speed 5 kn	70.0	70.0	71.0	m
Speed 10 kn	70.0	70.0	70.0	m
Speed 15 kn	70.0	70.0	70.0	m
Speed 20 kn	70.0	70.0	70.0	m
Speed 30 kn	70.0	70.0	70.0	m
Speed 40 kn	75.0	70.0	70.0	m

Pivot point distance from the bow
It's used as origin for XTD calculation
49.5 metr from the bow

Anchor position distance from the bow
10.0 metr from the bow

OK Cancel

Back to track function

This function is intended for creating of a new route with new waypoints to go back on a activated route, after the ship has to deviate from original route. The original route is not deleted.

1. Right click on the route and select **Back to track** menu.

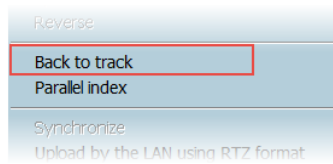

The warning message is displayed.

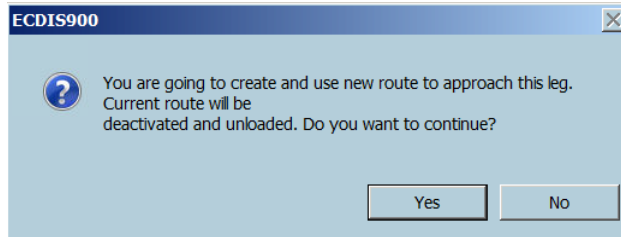

2. The more appropriate waypoint is selected as the start waypoint. When route is finished, double click to finish the route creating the first waypoint at the ship position.

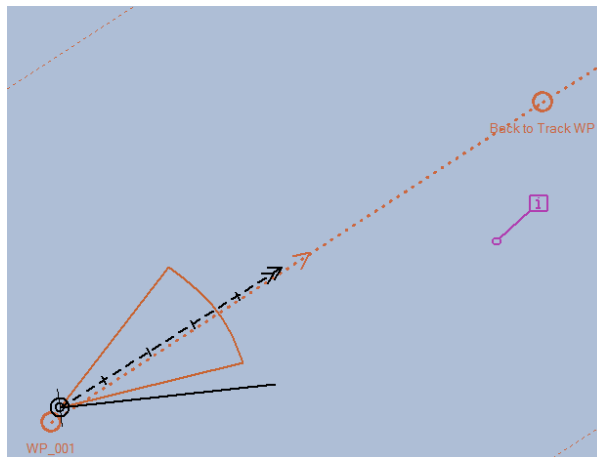

3. A new route is created, name is suffixed by _BACK. Right click to activate.

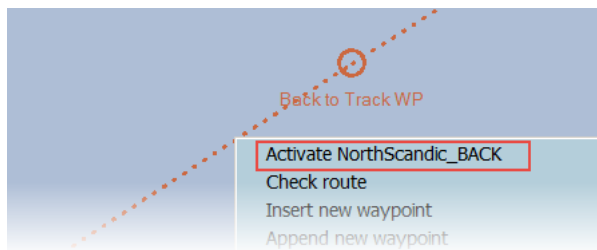

The new route is activated.

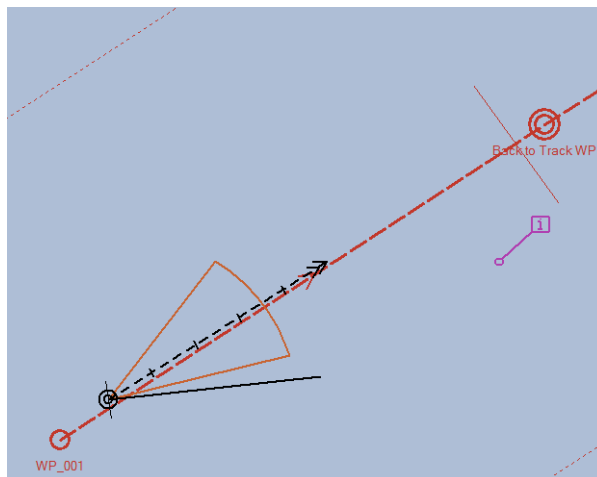

10

Waypoints

Active waypoint information

Active waypoint information are displayed in the **Route monitoring** console. To display the Route monitoring dialog, refer "*Console Options*" on page 27.

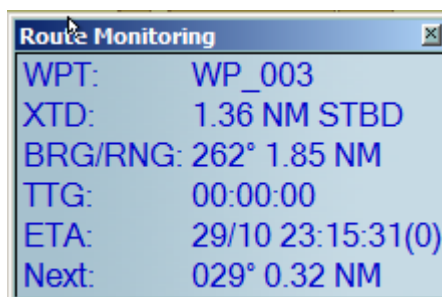

- **WPT:** The active waypoint name
- **XTD:** Cross Track Distance
- **BRG/RNG:** Bearing/Range to the active waypoint
- **TTG:** Time To Go to the active waypoint
- **ETA:** Estimated Time of Arrival
- **Next:** B/R for the next leg

Bearing to the active waypoint on a Great circle route leg

The displayed value of bearing to the active waypoint is changed in line with the position of the vessel. The ECDIS900 calculation includes following a great circle to the active waypoint.

Selecting waypoints

- Click once on a waypoint to select it. The waypoint is then highlighted.
- To add a waypoint to a selection click on the waypoint with the **Ctrl** key held down.
- To de-select a waypoint from a selection, click the selected waypoint with the **Ctrl** key held down.
- To add a complete route to a selection, click on one waypoint of the route with the **Ctrl** and **Shift** keys held down.
- Click once on a waypoint to select it. With Shift key down click on another waypoint: all waypoints of the located between the 2 clicks are selected.
- Using together with **Ctrl** the selection with the **Shift** key allows building complex selection of waypoint from existing routes.

Click the **Delete** key to delete a selection. Move a selection as described in the "*Modifying a route*" on page 100 or create a new route from the selection.

Selecting waypoints

You can create route from a set of selected waypoints. A new route may be created from one route as well as from several routes.

Use the **New route** button from the toolbar.

1. Load one or several routes
2. Select waypoints
3. Click the **New route** button and click **Yes** to create a new route.

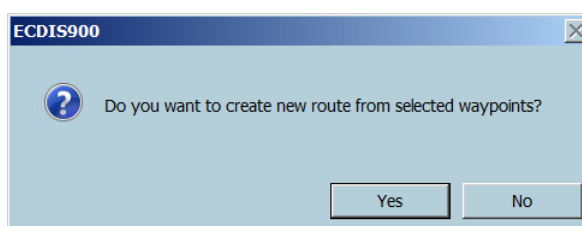

4. Enter a name for the new route and click **OK**. The newly created route is displayed and selected in the chart area.

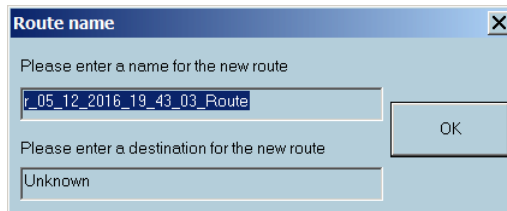

5. To continue plotting waypoints, right click on the route and activate the **Append new waypoint** menu item.

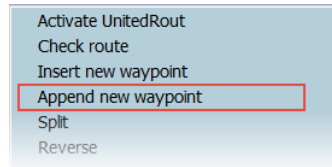

Create a route using several routes

You can create a new route using waypoints of several routes.

1. Load or create several routes.
2. Select waypoints on the routes. Hold **Ctrl** when selecting waypoints and **Ctrl** and **Shift** if you want to select entire route.

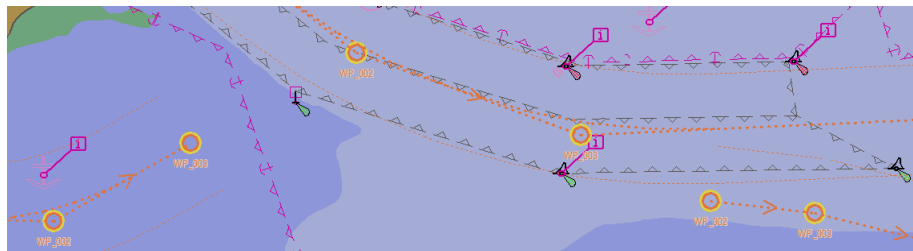

3. Click the **New route** button from the toolbar
4. Confirm, that you create the route

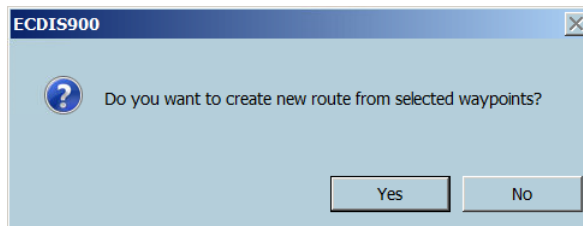

5. Enter the new route name and click OK

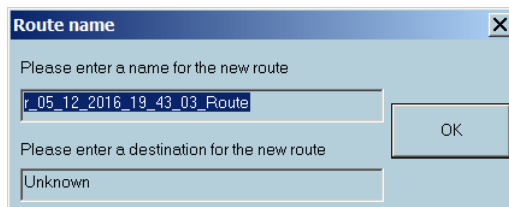

The new route is ready with all waypoints selected.

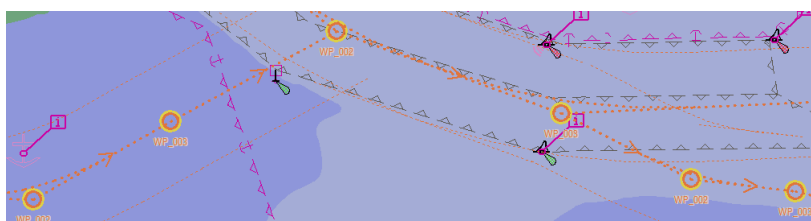

Waypoint properties

Locate the cursor on a waypoint, right click and select **Properties** from the pop-up menu. Alternatively move the cursor over the waypoint and press F4 several times to access the waypoint **Properties** dialog.

The properties dialog displays two tabs: **General** and **Information**

The screenshot shows the 'Waypoint WP_002' dialog box with the 'General' tab selected. The 'Name' field contains 'WP_002'. The 'Latitude' field contains '42 30.720N' and the 'Longitude' field contains '065 40.735W'. The 'Time zone' is set to '4.0'. There are three checkboxes: 'Display name' is checked, 'Display description' is unchecked, and 'Lock' is unchecked. Under 'Leg parameters', 'PortXTD limit, m' and 'StarboardXTD limit, m' are both set to '185.2'. The 'Use turn radius for ROT calculation' checkbox is checked. The 'Turning radius, NM' is '0.5' and the 'Rate of turn, deg/min' is '19.0985'. There are two buttons: 'Rhumbline' and 'Greate circle'. At the bottom, there are 'Date' and 'Time' input fields and a 'Fixed ETA' checkbox which is unchecked.

In the tab General the waypoint's position and relative parameters can be adjusted.

- **Name** it is possible to edit the value manually
- **Latitude** it is possible to edit the value manually
- **Longitude** it is possible to edit the value manually
- **Time Zone** To set the time zone of the waypoint if different from the system calculated TZ.
- **Display name** Toggle to display or not display the name on the chart.
- **Display description** Toggle to display or not display the description on the chart.
- **Lock Toggle** to lock or unlock the details of the waypoint.

The Information tab contains information of the nearest forecast station and linked files.

Plotting a waypoint outside the screen

Scroll

Scrolling the chart is achieved by moving the mouse outside of the chart area in the direction of the desired scroll or by pressing the arrows key on your keyboard.

Change scale

At any time during the route creation process, it is possible to zoom (in or out) or to change the scale of the chart by clicking right anywhere on the chart and selecting the desired scale. It is also possible to use the short keys F1 and F2 to zoom in and out.

→ **Note:** The scale menu depends on the type of chart in use.

Load another type of chart

Press **F9** to switch from ARCS to ENC when plotting the route.

Rename waypoints

By default ECDIS numbers waypoints consecutively. (WP_001, WP_002, etc)

If a new waypoint is inserted between two existing waypoints or a waypoint is deleted it is useful to re-number the waypoints from WP_001 again.

To re-number the waypoints shown in the route plan dialog box, click the column title **Name**.

Alternatively it is possible to re-number the waypoints in the Route properties dialog box by pushing the button **Rename the waypoints**.

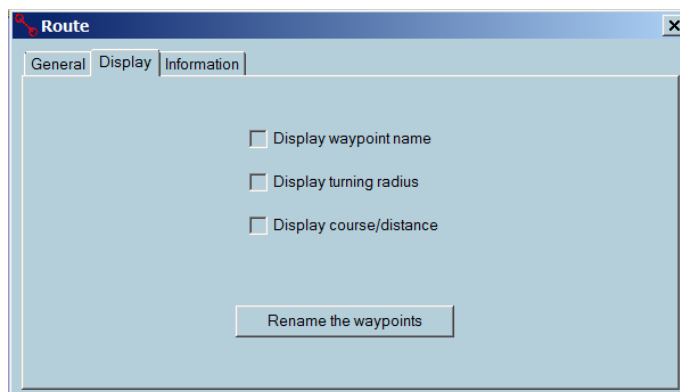

→ **Note:** the function **Rename the waypoints** is applicable only to waypoints with numbers which were set by default: WP_001, WP_002 etc. All manually renamed waypoints are ignored by this function. If you want to name waypoints, do it when the route has been approved.

Delete a waypoint

1. Select a waypoint in the list by clicking on its name
2. Click the **Delete waypoint** button or press the key **Delete** key from your keyboard.

Delete WP

→ **Note:** A route is defined by at least two waypoints. If the route contains less than two waypoints, the route is deleted and the route plan window closed.

→ **Note:** The selected waypoint will be deleted immediately, Use the **Undo** button to recover a deleted waypoint.

Move a waypoint in the list

1. Right click on the waypoint's name and select the menu Move after.

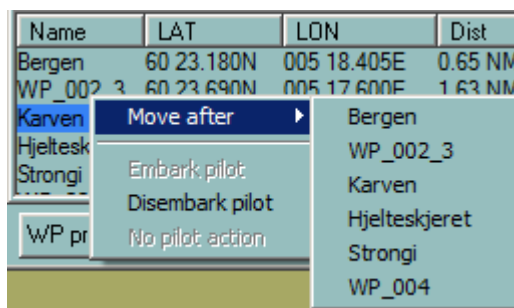

2. Then select the destination waypoint and the waypoint will be moved after the selected waypoint.

Waypoint ETA information

The panel WP ETA displays the ETA value for any waypoint selected by the user. The required waypoint is selected by clicking the small arrows on the RHS of the panel.

Select between Ship Speed and Planned speed by clicking the two buttons located under the arrows.

→ **Note:** If the panel is not displayed, the user can make it visible by clicking the button Option and checking on the box WP ETA in the console configuration panel. ETA for an active waypoint is always calculated using the ship speed.

Fixed ETA function

The console **Fixed ETA** displays the selected waypoint number, the ETA required by user, and the speed to be maintained to reach the selected waypoint on time.

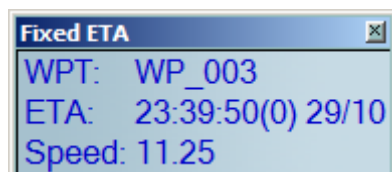

The Fixed ETA function can be used for any waypoint after the active waypoint. There are two ways to select the waypoint and enter the ETA.

The first: click right button on the waypoint, select Properties, check on the box Fixed ETA, and enter the ETA value.

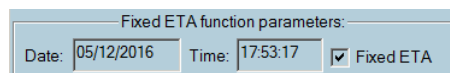

The second: in the route plan click on **ETA of the selected waypoint** and enter the ETA value.

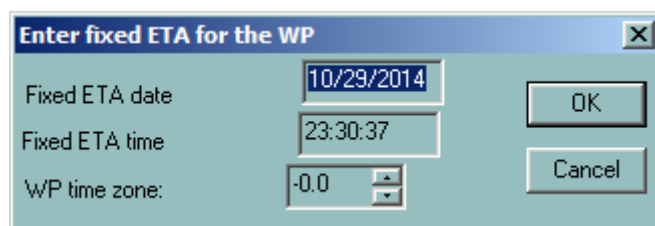

Waypoint arrival warnings and alarms

→ **Note:** These alerts are triggered if the TCS option is ON. See "*Configuring alerts*" on page 41 for details.

When a waypoint is crossed, the following alerts are triggered:

Time (default)	Alert	Alert type	Description
3 minutes before the WOP (Wheel Over Point)	Early course change	Warning	Does not require acknowledgement
30 seconds before the WOP	Course change	Warning	Ship starts turning onto the new course, does not require acknowledgement
WOP is reached	Course change	Alarm	Require acknowledgement
30 seconds after the WOP is passed	Back up navigator	Alarm	In case the Course change alarm was not acknowledged

You can define other time both for the Early course change and for the Course change. See "*Route options*" on page 111 for details.

After the turning is ended, the passed waypoint is deactivated while the next waypoint becomes active.

→ **Note:** When the **Course change** alarm is not acknowledged, the system considers the ship is out of control.

Then the alarm is triggered to make sound in other rooms of the ship to inform navigators out watch that something is wrong on the bridge.

When the last waypoint is reached, the **End of track alert** is triggered.

Change active waypoint

The active waypoint is selected automatically when the ship arrives at the waypoint. But at any time, the current waypoint can be changed manually.

There are different ways to select another active waypoint:

- Right click on the waypoint of the route to be activated and select **Activate** in the list
- In the route plan waypoint list, right click on the name of the waypoint and click **Activate**.

New waypoint by coordinates

1. Press the New WP by coordinates button.

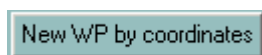

2. The dialog box appears

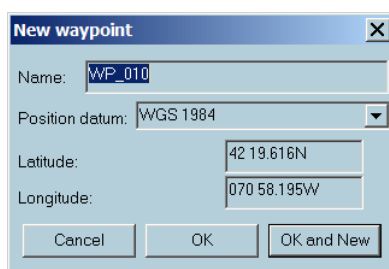
A dialog box titled "New waypoint" with a close button (X) in the top right corner. It contains the following fields: "Name:" with the text "WP_010"; "Position datum:" with a dropdown menu showing "WGS 1984"; "Latitude:" with the text "42 19.616N"; and "Longitude:" with the text "070 58.195W". At the bottom, there are three buttons: "Cancel", "OK", and "OK and New".

3. Click **OK** to enter the new waypoint. Change the latitude and longitude if necessary then click **OK** to enter the new waypoint. Click **OK and New** to enter more than one new waypoint. The waypoint(s) will be added after the previously selected one and the details for the route will be updated accordingly.

It is not possible to enter a new waypoint before the first waypoint with this method. To add a new waypoint at the start proceed as follow:

- Select the first waypoint.
- Press the **New waypoint by coordinates** button and enter the name and coordinates for the new waypoint.
- Right click on the first waypoint and select the menu **Move after** and select the number of the newly created waypoint.

→ **Note:** When a new waypoint is created, a default number is set for it. In order to have a consistent list of numbers for the waypoints, it is necessary to re-number the waypoints by clicking once in the column title called **Name**

New waypoint by bearing

1. Press the **New WP by bearing** button.

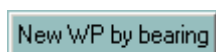

2. The input dialog box appears

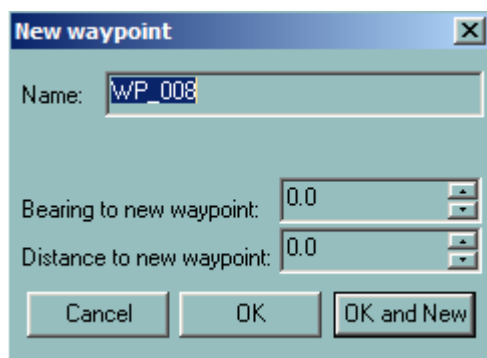
A dialog box titled "New waypoint" with a close button (X) in the top right corner. It contains the following fields: "Name:" with the text "WP_008"; "Bearing to new waypoint:" with a spin box showing "0.0"; and "Distance to new waypoint:" with a spin box showing "0.0". At the bottom, there are three buttons: "Cancel", "OK", and "OK and New".

3. Input the range and bearing then press **OK** to enter the new waypoint. Press **OK and New** to enter more than one new waypoint. The waypoint(s) will be added after the previously selected one and the details for the route will be updated accordingly.

- **Note:** When a new waypoint is created a default number is given. In order to have a consistent list of names for the waypoints it is necessary to re-number the waypoints by clicking once in the column title called **Name**

Set a new waypoint latitude/longitude

1. Click on the latitude and modify the value.

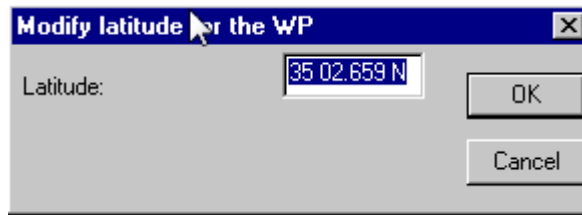

2. The longitude modification is performed by the same way. Click ion the longitude value in the list and input the proper longitude.

Set a waypoint as a Pilot waypoint

To set waypoints of embarking/disembarking a pilot, right click on the waypoint name and select the proper item.

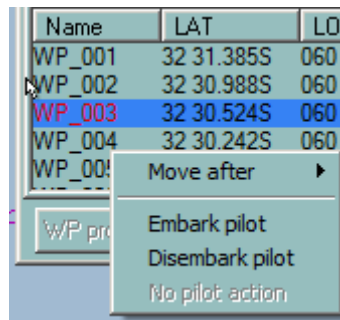

The waypoint name becomes red colored.

To cancel this waypoint property, select the **No pilot action** item.

Center the chart display on the waypoint location

Double click on a waypoint's name to center the chart on the waypoint location.

This function allows a graphical checking of the positions of the waypoints and legs.

11

Radar

Interface

There are two ways for the ECDIS900 to interface with radar:

- Connection to the ARPA radar via serial line
- Connection directly to the radar transceiver with the MK radar kit that delivers the radar target table and the radar video

All acquired targets are displayed on the electronic chart and the ECDIS900 manages the CPA/TCPA alarms.

Targets

The targets are displayed on the chart with special symbols. On request the name of the target and the past track can be displayed, the track can be saved on the hard disk and the target deleted in case of manual target. The target Properties display all information about the actual target and the target list contains the list of tracked targets.

The prediction tool allows calculating the future position of the targets.

To remove the target icons from the display, press the **F8** short key.

Radar antenna position

To set the exact position of the Radar antenna, refer to the **Shape** parameters from the **Ships properties** dialog. See "*Shape tab*" on page 44 for more details.

→ **Note:** The targets' positions are calculated from this reference point.

MK Radar Kit

With the MK PC radar kit the PC can be transformed to an advanced radar system. Combined this with ECDIS900, the radar picture can be shown on the chart and by means of the built-in radar tracker you will now have the most common ARPA functions available.

The system to be installed on one or two machines which may operate on a local network onboard the ship. MARIS radar tracking system has a unique capacity of tracking simultaneously up to 300 targets, making it capable of searching for and showing data much faster than any other system.

Target display

Target symbols are small circles with a speed vector, the vector length is being dependent on the speed of the target.

In case of CPA/TCPA alarms, the target's icon flashes.

Show and hide

Target icons may be hidden or shown.

- Press the short key **F5** to show or hide targets.
- Alternatively press the button **Hide target** in the target list.

→ **Note:** The target on CPA/TCPA alarm is always displayed on the chart.

Show and hide name

To display or hide a target's name, right click on the target icon and select **Show name** or **Hide name** on the pop-up menu

Show and hide past track

The target's track is continuously recorded in memory.

To display or hide a track, right click on the target icon and select **Show past track** or **Hide past track** on the pop-up menu.

Save the track

To store a target's track in the route database on hard disk click right on the target icon and select Save track from the pop-up menu.

To load/unload a recorded target track see "*Load, unload and delete tracks*" on page 39.

Delete a target

To delete a target, right click on the target icon and select **Delete** on the pop-up menu.

→ **Note:** Only manually created targets can be deleted.

Target properties

To view a target's properties, right click on the target and select **Properties** from the list.

Target properties	
Target ID:	31999
Vessel type:	Unknown
Target name:	Manual
Latitude:	32 30.992S
Longitude:	060 54.668E
Bearing:	250.7
Range:	0.43
CPA:	0.44
TCPA:	N/A
Course:	0.00
Speed:	0.00
Vector ground stabilised.	
<input checked="" type="checkbox"/> Name visible	<input type="checkbox"/> Past track visible
Delete	

- Target ID: Unique identity of the target
- Target name: Target name
- Latitude: Latitudinal position
- Longitude: Longitudinal position
- Bearing: Bearing of the target from the ship
- Range: Range of the target from the ship
- Vessel type: Type of target
- CPA: Closest point of approach of the target to the ship
- TCPA: Time of closest point of approach of the target to the ship
- Course: Course of the target
- Speed: Speed of the target

Manual target

You can create manual targets and keep their dead reckoning. These manual targets are managed the same way as normal targets acquired from the ARPA.

1. To plot a manual target, click on the **Set target** button on the toolbar
2. Place the cursor at the desired position and click. Targets will be drawn to the same color code as described above.
3. With the **Target properties** dialog box adjust the target latitude and longitude values, if necessary, and set its course and speed, if applicable.



Target prediction

To predict the position of the ship and any targets, press the **Target prediction** button on the toolbar.

The **Target prediction** dialog contains a time slide bar (in minutes).



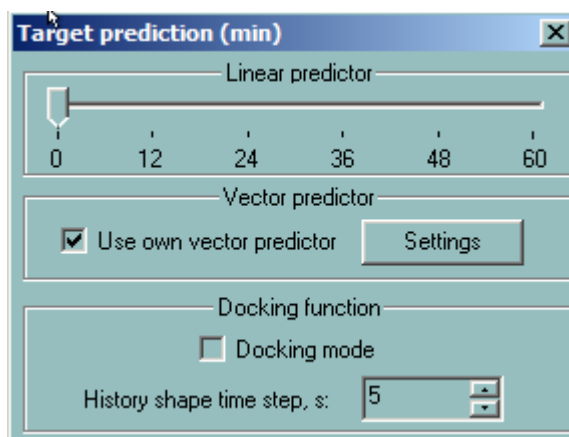

Move the slider to move the ship along its scheduled course by the corresponding time margin.

Use own vector predictor

Linear predictor calculates future positions according to current course and speed. The screen shows the predicted positions.

Press the **Settings** button to adjust the values if needed.

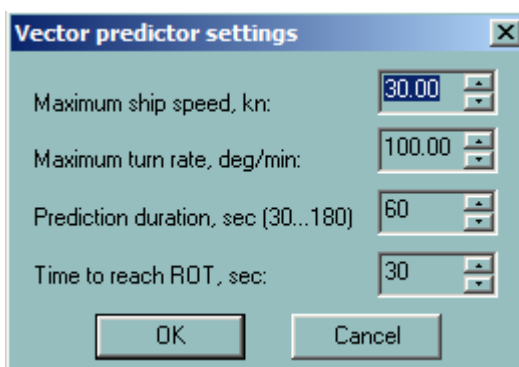

Target list

To display the list of the tracked targets click on the **Target list** button.

- Double click on the target name will center the chart on the target.
- Double click on the CPA title sorts out the targets by CPA values.
- Double click on the TCPA title sorts out the targets by TCPA values.

ECDIS900 acquires targets via serial line from ARPA radar connected to the system or using MK radar interface kit. In addition, ECDIS receives by serial line the targets from AIS when AIS is interfaced to ECDIS.

Center the chart and access properties

- Double click on the target name to center the chart on the target.
- Right click on the target's name to access to target's properties.

Show and hide targets

Press **Hide target** to hide the targets. All targets are hidden except the target on CPA/TCPA alarms which will always be displayed.

Relative vector

Press the **Draw relative vector** button to display the targets with relative vector. The relative vector is displayed with a dotted line to make a difference with the absolute vector.

AIS server

This function is dedicated Norwegian Pilots and allows connecting to AIS server providing the AIS traffic around Scandinavia.

Create a sensor called Client AIS Server using the Sensor Monitor application, start and stop the display of AIS data in ECDIS using the button **Start** or **Stop AIS server**.

Target window

Right click on the target (ARPA or AIS) and select **Display in a window** from the list.

A floating window centered on the target and following automatically the target is displayed.

It is possible to drag the window and different scale may be selected by right clicking inside the window. The window is closed by double clicking inside or selecting the menu **Close**.

→ **Note:** This feature is available on vector charts only.

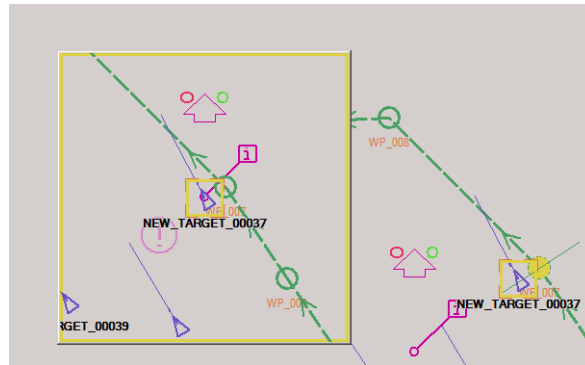

MK Radar kit

Components

MK PC Radar kit includes hardware and software components.

Hardware, software, and set up are described in the **Radar Kit MK6 Installation manual** delivered together with the PC Radar Kit.

Software components includes the following applications:

- Extractor/Tracker (VarpPCI.exe).
- Sensor Monitor (Sensor Monitor.exe).
- ETS Agent (ETSAgent.exe).
- PCI Board Adjustment (SetupETS.exe).
- Remote PCI Board Adjustment (RemoteSetupETS.exe).
- Oscilloscope (Oscilloscope.exe).
- MARIS ARPA-2000 (ARPA2000.exe).

→ **Note:** MARIS PC Radar Kit provides the ability of combining Radar operations with the ECDIS and is fully approved to IEC 61174 for overlay function. The Radar function ARPA2000 has not been tested.

The Sensor Monitor processes the navigational information from ship's sensors and sends it to Extractor/Tracker. In case if Extractor/Tracker does not react on change of heading check SMonitor.ini file.

Radar overlay

The PC Radar kit set the radar picture as a layer on top of the chart and automatically tracks the radar targets.

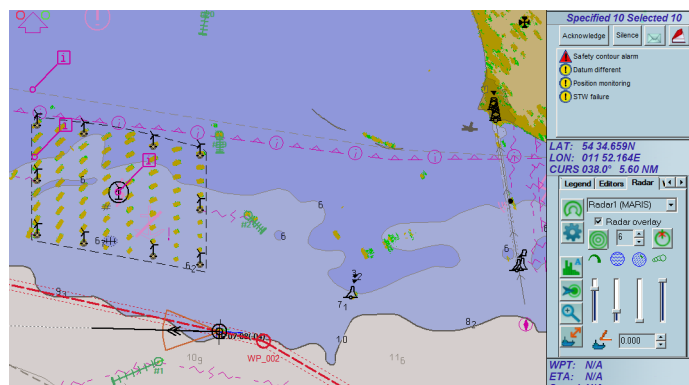

To suppress the overlay of the radar video on top of the chart, press the **F5** key and select the **No overlay** option from the list.

The Radar panel contains buttons and menus which provide the following functionality:

- Select radar source
- Activate radar overlay option
- Adjust the radar parameters
- Initiate and stop the tracking of targets
- Define an automatic acquisition zone in front of the ship
- Adjust the ship's position and compensate eventual gyro drifting

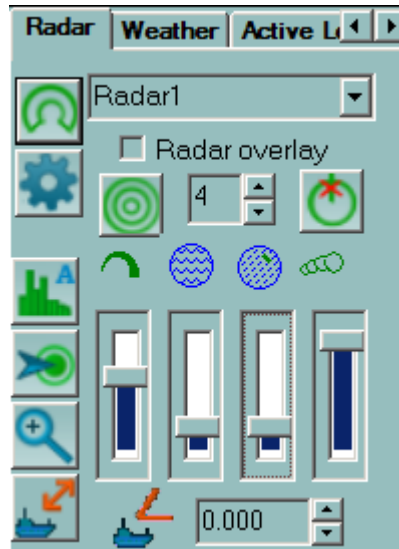

Display settings

To show the Radar picture on top of the chart, click the **Overlay** menu.

The Radar picture does not hide any chart information and is displayed in a transparency mode. According to the regulations, the Radar picture is displayed between two chart layers, and essential chart information (land contours, lights, and buoys, etc.) is displayed on the top of the Radar picture.

To adjust the radar parameter and display options, click the **Settings** button.

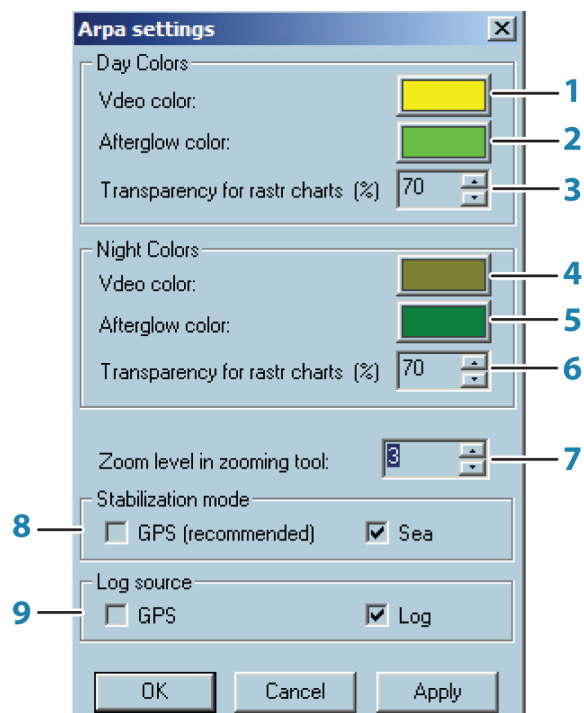

- 1 Color to show radar overlay in day mode

- 2 Color to show afterglow in day mode
- 3 The brilliance of the radar overlay, covering the black areas on the raster charts in day mode (in percent to specified color)
- 4 Color to show radar overlay in night mode
- 5 Color to show afterglow in night mode
- 6 The brilliance of the radar overlay, covering the black areas on the raster charts in night mode (in percent to specified color)
- 7 The rate of magnification in zooming tool
- 8 Stabilization mode for the Extractor/Tracker
- 9 The source of speed information for Extractor/Tracker

The specified colors are used in vector charts exactly as it is. In raster charts the specified color will be used for drawing the transparent radar video overlay over the white areas of the chart. The color used for drawing the video over the black areas of the chart will have the specified percentage of brilliance relating to the specified color (30% by default).

To modify the referenced color, press the colored button, and the dialog with 3 sliders for Red, Green and Blue components adjustment will appear. Use the Apply button to see the result of modifications without closing the dialog.

The stabilization mode and speed sources could be adjusted in case when not all ordinary sensors are available. The recommended combination is GPS stabilization and Log speed source.

Target tracking

MK PC Radar kit automatically tracks the radar targets but displays them only on request.

There are different ways to acquire targets:

- **Manually**
Click the **Acquisition** button and click on a radar echo. If a target is tracked, the system will display the target icon and the speed and heading vector.
 - **Automatically**
Click the **Radar guard zone** button and enter the parameters accordingly.
- **Note:** This is only possible when an automatic acquisition zone in front of the ship is defined.

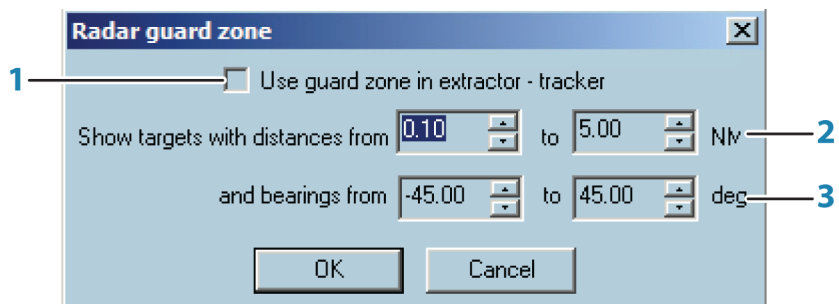

- 1 Tick on to apply the guard zone to the Extractor/Tracker
- 2 Start and end range of the guard zone in NM
- 3 Start and end bearings of the guard zone in degrees

→ **Note:** When an automatic acquisition zone is defined it's also possible to simultaneously track targets outside of the zone.

The targets automatically detected by the system inside the zone will be displayed as long as they are inside the acquisition area.

To delete a target, click right on the target and select **Delete**.

Tools

Several tools activate the functionality connected with the cursor:

Manual acquisition

After pressing the **Acquisition** button with left mouse button, the next left mouse button click over the chart area will be assumed as the manual acquisition command for the Extractor/Tracker. If the button was pressed with right mouse button, all next left mouse button clicks over the chart area will be assumed as manual acquisition commands until the button will be released.



Manual position offset

GPS adjustments: Overlapping the radar picture on the chart allows controlling the accuracy of the GPS position. Indeed when, for example, a buoy displayed on the chart and its radar echo do not match this is probably due to the ship's position calculation accuracy.

To adjust the position of the ship use the tool **Ship position offset**.

Click on the radar echo on the chart, then drag the mouse and click on the corresponding chart object.

Then GPS is shifted and the values of the shifting are displayed in the position panel.

To release the shifting values click right button in the position panel and activate the **Clean position offset** menu.

Gyro drift

When the radar picture is slightly rotated compared to the chart, the drifting of the gyro is probably the cause of the problem. To adjust the gyro in ECDIS900 enter the corrective value of the heading with the small arrows. Then the radar picture will be rotated accordingly and the gyro shifting value displayed in the Heading panel.

Zooming tool

- Press the referenced button the cursor is changed to prompt for the zoomed area selection.
- The square zooming window appears after the left mouse button click over the chart area.
- The window represents the zoomed area below the central point.
- The zooming rate could be specified in **ARPA Settings** dialog in range 2 – 6.

The zooming window could be dragged using the mouse, and zoomed content will be updated after fixing the window on certain position for a while.

The radar video in zooming window is updated synchronously with the radar antenna rotation. The zooming window disappears automatically if not moved in 15 seconds. Also it could be closed manually with pressing the referenced button on the Radar property page second time.



Known/common errors

The most common errors with the radar overlay are normally related to the network connection. Contact your IT department to verify the network connection.

The colors of video overlay are not satisfactory

Use the **ARPA Settings** dialog to modify the colors. If the video overlay is too dark in the raster charts, try to increase the **Low color value (%)**. This will decrease the transparency of the radar overlay, but the brilliance of radar video layer over the dark parts of the chart will be increased.

The radar overlay does not correspond to the chart

It is necessary to check if the system gets proper information from all necessary sensors. The Gyro data is the most important. Compare the information displayed on the ECDIS with information available on the sensor displays:

- If ECDIS does not have this information, check the data in Sensor Monitor.
- If ECDIS gets proper navigational information, but the radar overlay is not properly arranged, follow the steps below:

1. Run the **ARPA 2000** application
2. Check if the own ship parameters are displayed correctly, mainly heading and speed.
3. If there are zero values for all navigational parameters and referenced alerts are displayed in ARPA 2000 Alarm Box, it means that the Extractor/Tracker does not receive the navigational information:

- Check if one Sensor Monitors in the system is in the Master mode.
 - Check if the IP port is specified for sending the data to Extractor/Tracker. This port must be the same as specified in LAN, **NavigationInPort** parameter of the **VarpPCI.ini file** located in C:\Program Files\Maris\PC Radar Kit\ on the computer where the PC Radar Kit hardware is installed.
4. If ARPA 2000 shows proper navigational parameters, but the radar overlay is not correctly arranged:
- Activate the System dialog in the ARPA 2000. Refer to the ARPA 2000 user manual.
 - Click the ► or ◀ buttons until the Extractor parameters page is displayed
 - Modify the **Headup** parameter to adjust the orientation of the radar overlay. Ensure to check it in ECDIS after each modification.
 - Modify **Sync Delay** parameter to adjust the distances to objects. The distance to certain radar echo is back-proportional to the Sync Delay value.

12



Alert management

The ECDIS900 system must provide alerts and indications to inform about critical or non-critical failures and other events. Alerts are indicated on each ECDIS workstation and are synchronized with BAMS.

Display notifications

When an alert is triggered, an alert message is displayed in the alert area located in the console and the danger is highlighted on the chart or in the console area.

Alerts are categorized in 3 priority levels:

Level	Basic symbol	Priority and classification	Description
1		Alarm	Requires immediate attention and action of a bridge team to prevent the alarmed situation and hold safe ship operation. Escalation is an alarm from non acknowledged warning.
2		Warning	Requires of immediate attention of a bridge team and make the team aware of conditions which may become hazardous. For example, approaching to a critical point.
3		Caution	Indication of a condition which requires attention, but does not require action. For example, AIS target display capacity is about to be exceeded. The caution is marked with a yellow square. This alert goes on and off while the indicated condition exists. Acknowledgment is not required.

By default a sound signal accompanies an alert message that is not acknowledged and the pulse frequency of the flashing of the alert button is 1 Hz.

The following sound patterns are used:

- Alarm: 3 beeps each 10 seconds; the alarm can be silenced once without acknowledge for the 30 seconds.
- Warning: 1 beep each minute.

Alarms and warnings are accompanied by an appropriate audible signal pattern emitted by a buzzer located in the front frame of the monitor or in a panel.



Silence mode is available for the alarms once and no longer than for 60 seconds. After that alarm must be acknowledged.







To avoid alert in harbor and berthing condition, activate the Harbor mode.

Acknowledging alarms

To acknowledge an alert double click on the alarm message or click the **Acknowledge** button after selection of the message.

The following icons indicate the current state of alerts.

Alarm symbol	Warning symbol	Alert state	Indication
		Active, Unacknowledged, Not silenced	<ul style="list-style-type: none"> • Flashing symbol + description text • Relevant audible signal generated

Alarm symbol	Warning symbol	Alert state	Indication
		Active, Unacknowledged, Silenced	<ul style="list-style-type: none"> Flashing symbol + description text Silenced horn
		Active, Acknowledged	<ul style="list-style-type: none"> Steady symbol + description text Silenced horn
		Rectified, Unacknowledged	<ul style="list-style-type: none"> Flashing symbol + description text

Alternatively click the **Return** button to acknowledge all alerts.

→ **Note:** Alerts should not disappear automatically in case alert condition is not applicable.

Caution alerts no need to be acknowledged.

If alert symbol is flashing, then alert is not acknowledged.

There are two warnings that are escalated to alarms in case of being unacknowledged:

- Course change alert. CC acknowledge interval can be changed by user.
- Anchor watching. The interval for acknowledge is 1 minute and cannot be changed.

ECDIS in network

When several ECDIS workstations are connected in a network, acknowledgement of alarm is synchronized, i.e. when an alert is acknowledged on one PC this alert is acknowledged on all PCs with the exception of user defined alerts which are local on the PC.

List of alerts

Alerts have two categories:

- **A:** The information is required for the decision support. The A category alerts are generated by workstation. All alerts of the A category require to be acknowledged. Can be acknowledged on the ECDIS PC only.
- **B:** no additional information is required for the decision support. The B category alerts are generated by navigational system. Can be acknowledged on the BAMS.

Alerts of the category A

Information	Type
Crossing safety contour	Alarm
Area with special conditions	Alarm or indication
Deviation from route	Alarm
Crossing a navigational hazard	Alarm or indication
Approach to critical point	Warning or alarm
AIS target processing/display capacity is about to be exceeded	Caution
AIS target processing/display capacity have been exceeded	Warning
Outside anchor watch area	Warning
CPA/TCPA	Alarm

Alerts of the category B

Information	Type
Positioning system failure	Warning
Different geodetic datum	Warning

Uncategorized alerts

Information	Type
Discrepancies between positions	Indication
Manual position adjustment	Permanent indication
Default safety contour	Indication
Information overscale	Permanent indication
Larger scale ENC available	Permanent indication
Different reference system	Permanent indication
Target processing/display capacity is about to be exceeded	Indication
Target processing/display capacity have been exceeded	Indication
Lost target warning enabled or disabled.	Indication
AIS target filter status	Permanent indication
Vector mode, time and stabilization	Permanent indication
No ENC available	Indication
Standard display is customized	Permanent indication
Route planning across the safety contour	Indication
Route planning across specified area	Indication
Route planning across navigational hazard	Indication
System failure	Indication
Chart display includes non-ENC data	Permanent indication
SENC data from non-HO source is in use and presentation is different from IHO S-52	Permanent indication
Off state of route planning across safety contour, prohibited areas and hazards indication	Permanent indication
Off state of safety contour, prohibited area and hazard indication in route monitoring	Permanent indication
Chart scale is not uniform over the displayed area	Permanent indication
Viewing date or date range does not include current date	Permanent indication
Chart orientation is not uniform over the displayed	Permanent indication
Out of sequence update	Permanent indication
Special area	Caution or warning
Navigational hazards	Caution

When the TCS function is ON, the Course change alerts are generated. See "*Waypoint arrival warnings and alarms*" on page 124 for more details.

User defined alarm

Each user defined object plotted using Object Editor may be defined as a danger and therefore may trigger an alarm:

- An isolated object when the point is inside the ship's guard zone or inside the safety corridor of a route.
- A line when the line intercepts the guard zone or the safety corridor of a route.
- An area when the area intercepts the guard zone or the safety corridor of a route cross the line.
- User defined alarmed areas will be considered as **No go** area in VDS module

Assign alarm

Alarm object

The object editor (OE) is used to plot user data on the charts: simple point, lines or areas. An alert object is a geographical area, which triggers an alert when the ship sails into it or when a planned route crosses it.

Define alarm object

Right click on the object outline, plotted on the chart, and click **Set alarm** in the pop-up menu.

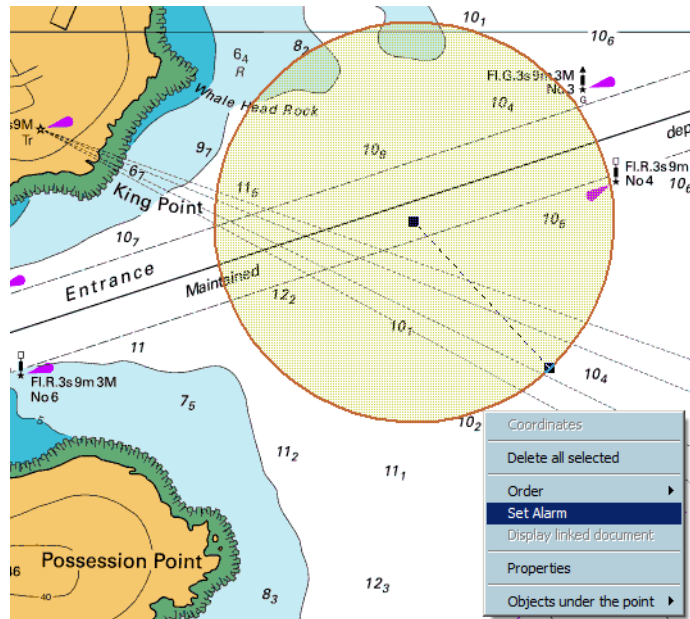

The object outline changes to red to underline that it has become an **alarm object**. It has width of one pixel and no filling for area.

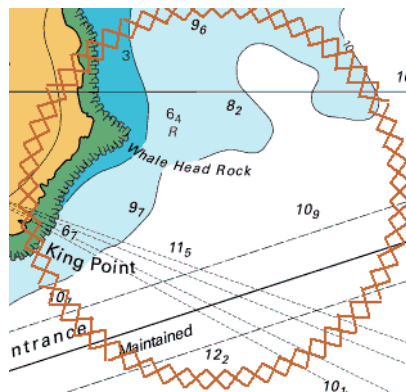

Where the alarmed object is a point, this is surrounded by a red rectangle.

When the object triggers an alarm the display changes, the lines are drawn in red, 2 pixels width.



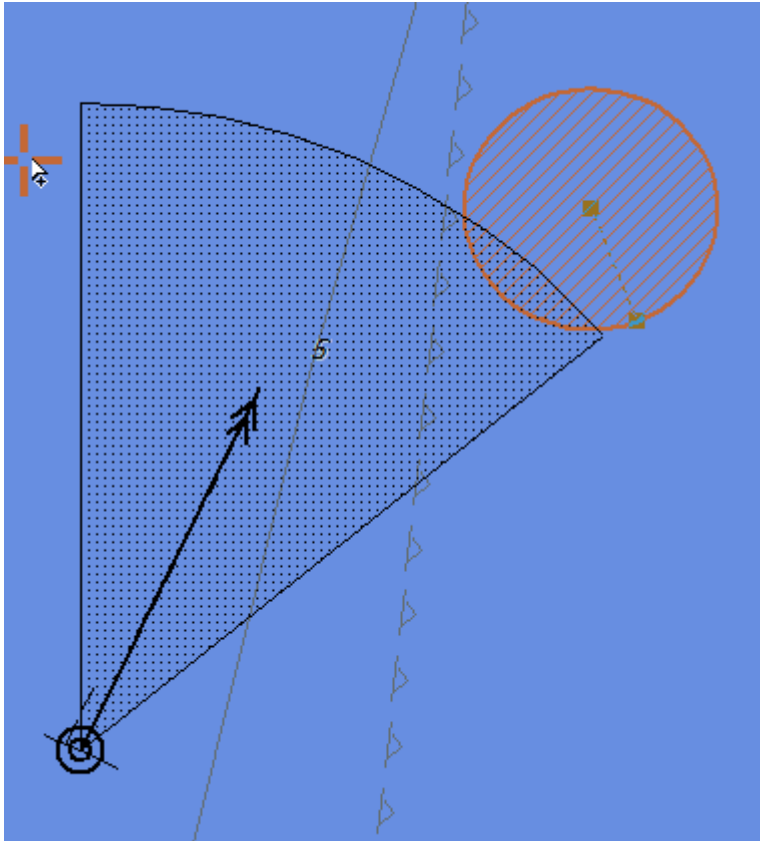

Monitoring user alarm

When the ship's guard zone intercepts an alarmed object an alarm is triggered. The alarm is displayed as long as the alarmed object remains inside the ships guard zone.

→ **Note:** The guard zone depends on the time and speed of the navigation.

Release alarm

To release an alert on one object right click and activate the item **Delete alarm** or select all alert objects using the item menu **Select all alarm objects** in the menu **Edit** in the editor panel and press the **Delete selected objects** button.

Anchor watching

The function controls the ship position relative to an anchor point. To set the offset value, open the F-Distance dialog from the Shape tab of the Ship properties dialog. See "*Shape tab*" on page 44 for details.

1. Right click on the ship icon and select Anchor watch from the menu.

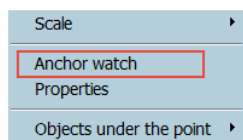

2. An red circle defines the anchor safety area when the alert is active. The radius is set in the F-Distance settings dialog.

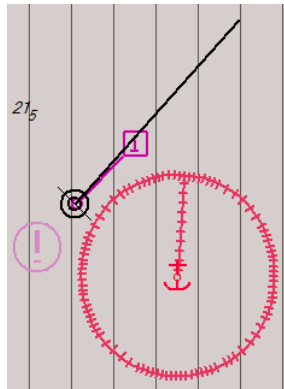

The warning is activated when the ship is outside the circle. If after 1 minute the warning is not acknowledged it is escalated to alarm. If the alert is not triggered, but the function is on, the circle has green color.

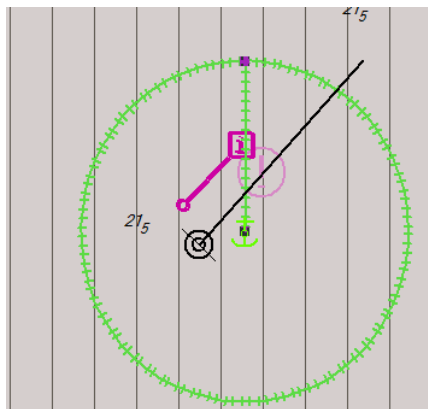

Harbor mode

To suppress alerts (buzzer and external BAS) when vessel is in the harbor (berthing or whatever), switch on **Harbor** mode. Alerts are disabled and chart area is hidden by big panel indicating that ECDIS is OUT of navigation mode.

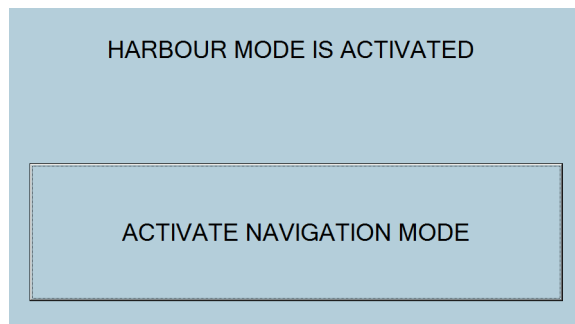

CTRL+H short key is used to activate the function. Press the button on the harbor panel, and the system is back to the navigation mode.

13

Automatic Identification System (AIS)

Interface

The AIS transponder communicates with the ECDIS via a serial cable (NMEA 0183 protocol). The duplex link between the AIS and ECDIS provides two-way communication:

- The ECDIS receives dynamic data (targets' positions and information) and messages from AIS (see "*Receiving messages*" on page 148).
- The ECDIS transfers own ship's static and voyage data to the AIS.
- The ECDIS may also be used to send messages to selected recipients (see "*Sending messages*" on page 148).

ECDIS provides different update intervals for low speed and high speed targets. For example, anchored target has 180 seconds for update while the high speed target has 2 seconds for update. This approach increases the display capability of the system.

→ **Note:** Ship's static data including Ship's name, length, etc. are used in both AIS transponder and ECDIS900 and can be entered either in AIS device either in ECDIS900.

The AIS transponder sends regularly ship's static data to ECDIS900 and vice versa ECDIS900 may send ship's static data to the AIS device.

→ **Note:** Class A AIS is provided for SOLAS ships and provides full data. Class B AIS is for non-SOLAS craft providing a subset of that data.

If the user decides to use in ECDIS900 the static data entered in the AIS transponder, ECDIS900 should not send the static data to the AIS. Therefore, when setting up the communication in Sensor Monitor tick off the flag **Send data to the transponder**.

Two kinds of filters can be applied to the sensor data.

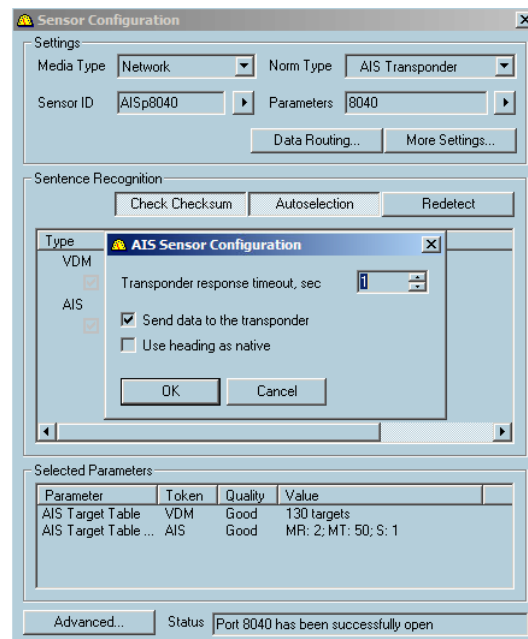

AIS Sensor can be switched to the Native heading mode but the AIS heading could be unreliable or not precise enough. So the proper warning appears if the **Use heading as native** item is ticked on. Press **Yes** to switch on the mode or **No** to back to the previous state.

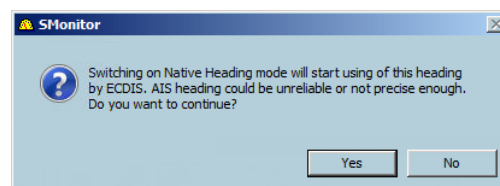

To optimize the number of displayed targets, press the **AIS filtering** button and set the filter criteria in the dialog.

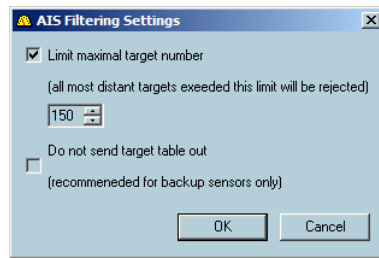

→ **Note:** In case the AIS number exceeds 95% of the limit maximal target number, the alert indication **AIS capacity** is displayed. The default target number limit can be changed. When the target number is over 95%, all close data is displayed, but data of some distant targets can be lost.

Minimum part of the total capacity which may be activated AIS ship targets, Class A and Class B is 40.

Minimum total capacity for all Class A (active and sleeping), Class B AIS (active and sleeping), AIS AtoN, AIS Base Station, AIS-SART and SAR Aircraft is 240.

Broadcasted data

The AIS transponder broadcasts three different types of data to other AIS installations or base stations:

- Static ship data including Ship's name, IMO number, call sign etc.
- Voyage related data including Destination and ETA.
- Dynamic data including position, heading and speed, ROT (Rate of Turn if available) etc.

Static ship and voyage related data is sent every 6 minutes.

The dynamic data sending rate depends on the ships speed. The dynamic data is sent every 5-10 seconds when the ship is making more than 3 knots but the delay is increased up to 3 minutes when the ship is making less than 3 knots.

Targets

AIS targets are displayed on the chart with a special symbol. On request the name of the target (see "*Show and hide AIS target's name*" on page 147) and the past track (see "*Show and hide past track*" on page 147) can be displayed and the track can be saved (see "*Save the track*" on page 147) on the hard disk. All information about the selected target is displayed in the dialog Properties of AIS target. Target list contains the list of targets currently being tracked (see "*Target list*" on page 129).

The prediction tool allows the user to display the future position of the targets (see "*Target prediction*" on page 128).

AIS Sleeping parameters (see "*Sleeping target*" on page 144) and target associations lets to adjust the target display (see "*Target association*" on page 145).

Lost targets

ECDIS manages both ARPA and AIS lost targets. If no position is received within 3 minutes, a target is considered as lost and ECDIS displays the lost target on the chart with a special icon (triangle with a cross line and no vector). Then if no data is received within the next 30 seconds, the target is deleted from the target table.

Own ship data

Voyage data

When ship's static data received from AIS device is used in ECDIS900, it is displayed in the Ship's properties, AIS tab (see "*AIS tab*" on page 46).

A green icon displayed in front of the parameter means that ECDIS900 settings are the same as the AIS settings for the selected parameter. If the icon is red, the parameter of AIS is different from the parameter of ECDIS900.

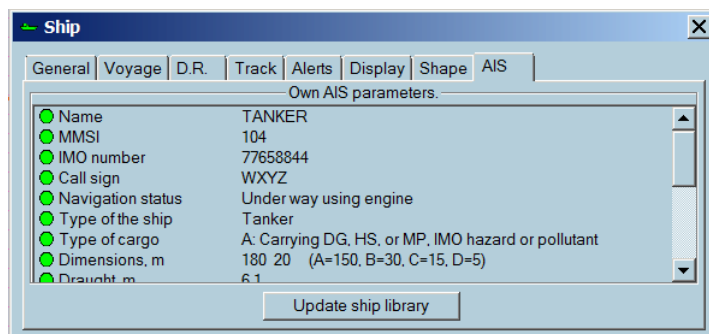

If any discrepancy exists, ECDIS900 proposes to synchronize the data with the data received from AIS transponder.

Voyage data has to be entered in the AIS transponder for each voyage.

When a route is activated in ECDIS900, the voyage data is calculated by the ECDIS.

These data can be sent automatically to the AIS transponder, but you can manually enter data and send it to an AIS transponder.

The voyage information is displayed and entered in the Voyage tab in the Ship properties dialog. The option Manual entry must be checked to be able to enter manually the voyage data (see *"Modifying the voyage information"* on page 37).

Ship and voyage data are automatically sent via the serial link to the AIS transponder.

AIS target display

The AIS target symbol is a blue triangle with a speed vector (dotted line) and the COG vector (continuous line). The speed vector length depends on the speed of the target (true vector) or on both own ship and target speed (relative vector).

By default AIS target outline is not displayed. To display the scaled ship icon (outline), tick on the proper option in the AIS Sleeping and association. See *"Sleeping target"* on page 144 for details.

True vector

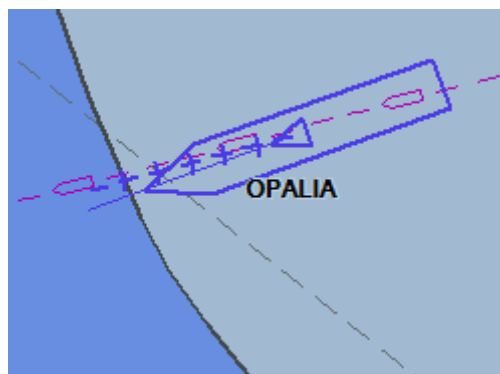

Relative vector

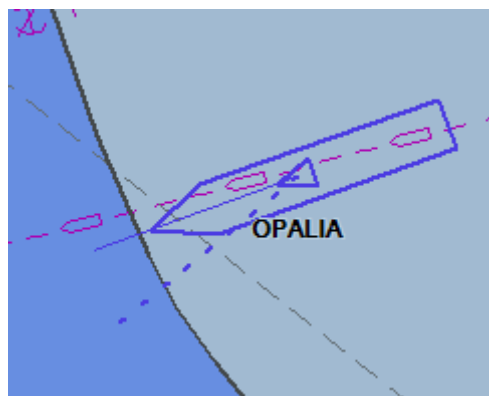

When a target is lost, the vector is no longer displayed and a small line crossing the green triangle shows the status of the target in the table. On the chart the blinking red cross appears over the AIS symbol indicating the lost target.

Vessel name	MMSI	CPA	TCPA	Range/Bearing	Ship type	Call sign	Na
▲ AIS IOPALIA	1	0.40nm	42.6min	0.53nm 304.5°	Tanker	MZFC4	Un

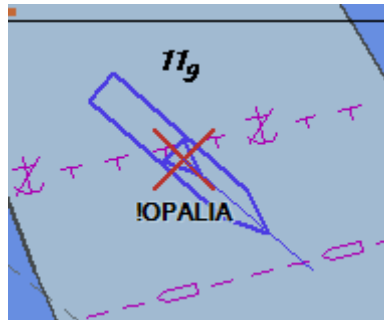

When the set CPA/TCPA alarms are activated the icon blinks.

→ **Note:** If the Rate of Turn (ROT) is received for a specific target, a small bar is displayed at the end of the target vector indicating the direction of the turn.

CPA TCPA alarm

When the CPA TCPA alarm is generated, the target symbol becomes red and it blinks.

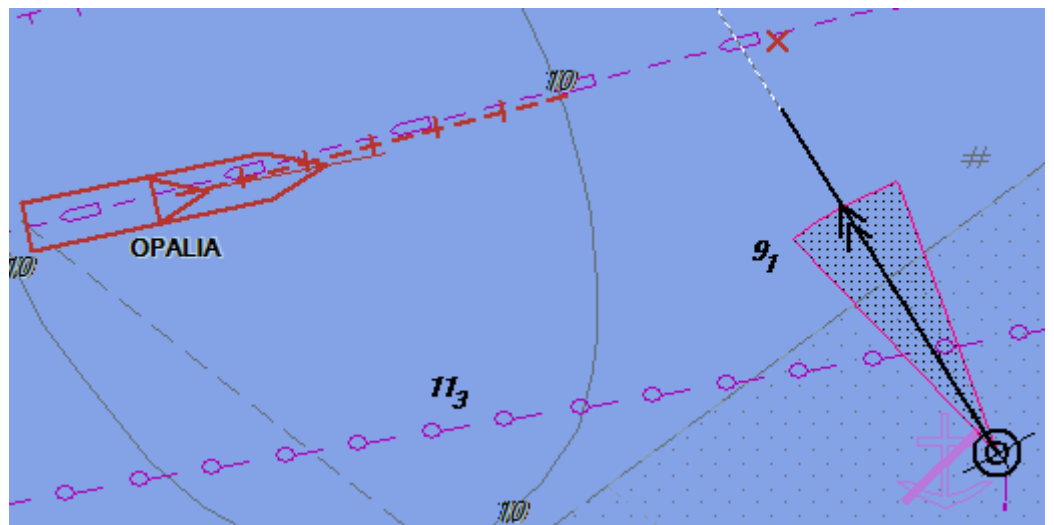

Sleeping target

It is possible to display name of targets only in a specified range around ship.

Select options in **AIS sleeping criteria settings**.

In Target console, right click and open dialog window to adjust range or CPA alarmed targets.

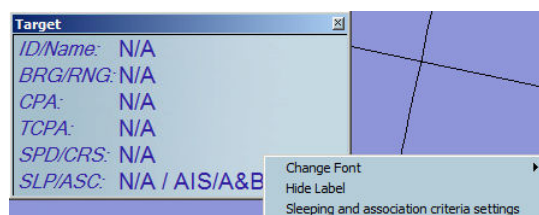

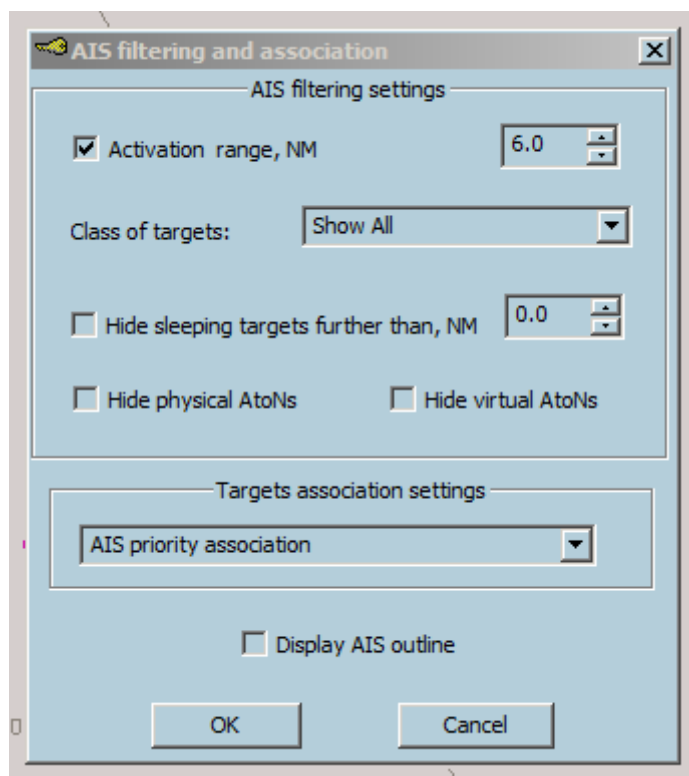

If the sleeping filtering function is activated, the following range values are displayed in the target console:

- Filtering range value
- Maximum distance of AIS target at the moment, that is sent from the Sensor monitor.

Target association

According to the ARPA regulation, an automatic target association function is provided based on harmonized criteria. When the function is enabled, it avoids the presentation of two full target symbols for the same physical target.

If the target data from AIS and radar tracking are both available, and if the association criteria (for example, position, motion) are fulfilled such that the AIS and radar information are considered as one physical target, the activated AIS target symbol and the alphanumeric AIS target data shall be automatically selected and displayed, with the provision of an alternative priority in below.

The user has the option to change the default condition to the display of tracked radar targets and shall be permitted to select either radar tracking or AIS alphanumeric data. Once a TT target and AIS target have become associated, hysteresis shall be applied to the criteria to set the new criteria or disassociation. For practical applications, it shall be permitted to vary the association and disassociation criteria by up to 300% of the default values. Association for Class A and Class B AIS targets are permitted, but the lower update rate on Class B AIS targets may limit or prevent association.

Select an option in the **Target association settings** list.

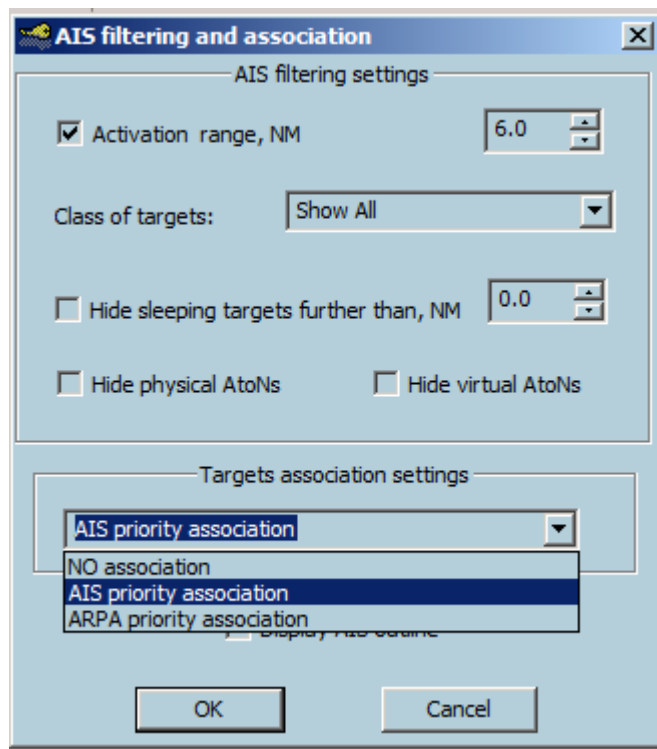

3 options are available:

- No association
- AIS priority association
- ARPA priority association.

It is possible to change the selected option at any time, but only operating in the Monitoring station mode.

- Selected option is displayed in target console (SLP/ASC).
- Display of associated targets is done according to current standard.

Name of associated target displayed on the chart in brackets after the name of main target. This makes possible to get access to appropriate target properties in the target table. In the target table no association is used and data is displayed as it is.

Lost target alert

This alert is warning.

→ **Note:** The alert is available when the CPA/TCPA alarm function is enabled.

Press button to configure alert when a target is lost within a given Range around ship position. This alert is available for both AIS and ARPA targets.

1. Press the Lost target button to open the dialog
2. Check box to activate alert
3. Set the value of the range

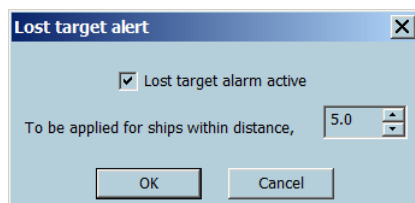

→ **Note:** When the alert is active, lost targets are not removed automatically from the list after normal timeout (1 min). Alert acknowledgment will remove lost targets from the list.

Show and hide AIS target's name

To display or hide a target's name, click right on the target icon and select **Show name** or **Hide name** on the pop-up menu.

→ **Note:** The user may also select to hide or show the name from the target's properties dialog.

Show and hide past track

All AIS tracks are automatically recorded in memory (up to 3 hours).

To display or hide a track click right on the target icon and select **Show past track** or **Hide past track** in the pop-up menu.

→ **Note:** A track is hidden by default. To show the track, toggle on **Past track visible** in the Target properties dialog.

Save the track

To store a target's track in the database of routes and tracks, which is stored on the hard disk, right click on the target icon and select **Save track** from the pop-up menu. The track is recorded for 3 hours with 30 seconds time stamp.

The saved AIS tracks are stored in the same database as the own ship and saved ARPA tracks. To load or unload procedure of recorded target tracks see "*Managing track recordings*" on page 38.

AIS target properties

To view the properties of a target, click right on the target and select Properties from the pop-up menu.

It is also possible to view to the properties from the target list dialog. Right click on the name of the target.

The General panel displays static information about the target and the Navigation panel displays information about the voyage and the dynamic data.

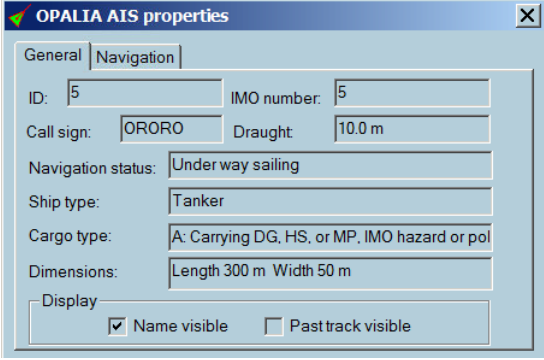

OPALIA AIS properties			
General	Navigation		
ID:	5	IMO number:	5
Call sign:	ORORO	Draught:	10.0 m
Navigation status:	Under way sailing		
Ship type:	Tanker		
Cargo type:	A: Carrying DG, HS, or MP, IMO hazard or pol		
Dimensions:	Length 300 m Width 50 m		
Display	<input checked="" type="checkbox"/> Name visible <input type="checkbox"/> Past track visible		

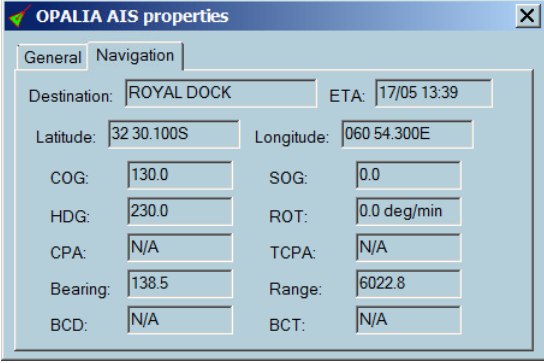

OPALIA AIS properties			
General	Navigation		
Destination:	ROYAL DOCK	ETA:	17/05 13:39
Latitude:	32 30.100S	Longitude:	060 54.300E
COG:	130.0	SOG:	0.0
HDG:	230.0	ROT:	0.0 deg/min
CPA:	N/A	TCPA:	N/A
Bearing:	138.5	Range:	6022.8
BCD:	N/A	BCT:	N/A

Messages

The AIS messaging system lets to send short messages to and receive messages from an AIS transponder.

The following VDL messages are also processed and displayed:

- 1, 2, 3, and 5 (Class A AIS and AIS-SART)
- 18, 19, and 24 (Class B AIS)
- 9 (AIS on Airborne SAR craft)
- 21 (AIS AtoN)
- 12 and 14 (Safety related messages)
- 6 and 8 (AIS application specific messages)

ECDIS provides an elegant and efficient interface to this messaging facility

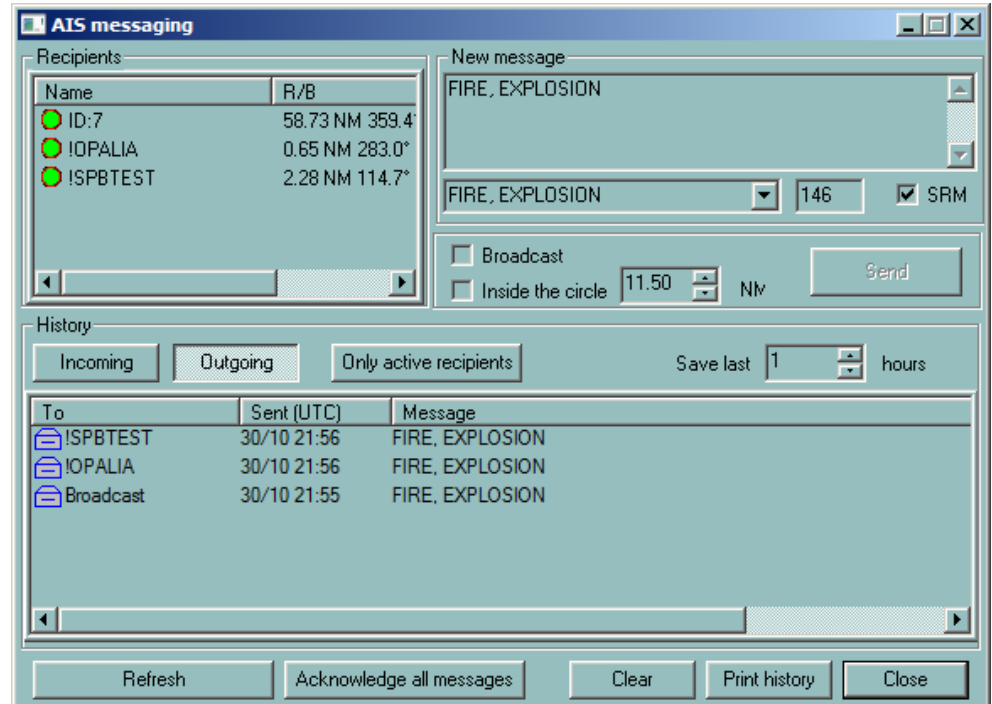

Receiving messages

When a new message is received by the AIS, it is automatically transferred to ECDIS and the notification is blinking small blue envelope icon (displayed next to the acknowledgement button in the alarm panel).



1. Click on the envelope icon to display the messaging dialog and click the **Incoming** button to see incoming messages.
2. New messages are listed in the lower part of the window with the senders name and the time of reception.
3. Click on the line to display the full message in the upper part of the dialog.
4. Double click on the message to acknowledge it or push the **Acknowledge** button to acknowledge all messages. The messages that have not been acknowledged are displayed as bold.
5. Right click on the message to delete it from the list or click **Clear** to delete all messages.
6. Select how long you want to keep the messages in the log with the **Save last** parameter.
7. Print all messages with the button **Print history**.
8. Display the incoming messages from only the active recipients, i.e. the current received AIS signals.

→ **Note:** When a received message is not acknowledged, the message is displayed on the chart next to the target name of the AIS sender.

Tip: Right double click on the message centers the chart on the AIS target.

Sending messages

Click on the blue envelope icon located in the Alarm panel or use the keys **Ctrl + A** or click the **AIS messaging** button in the target list or right click on the target and select the menu **Send text message** to bring the AIS messaging window in front.

1. Select **Outgoing message**. The list of sent messages is displayed in the lower part of the window.
2. Type a new message in the new message text box or select a pre-formatted message with SRM pop-up.
3. Select a recipient or check on the Broadcast box and click the **Send** button. It is also possible to send broadcast message within a circle defined by the radius **Inside the circle**.
4. When the MOB button is pushed, an AIS SRM message is automatically broadcasted.

AIS data server

Scandinavian AIS traffic is accessible via Internet. To connect to the dedicated WEB site login name and password are required.

Set up

In Sensor Monitor create a sensor, norm Internet AIS Client.

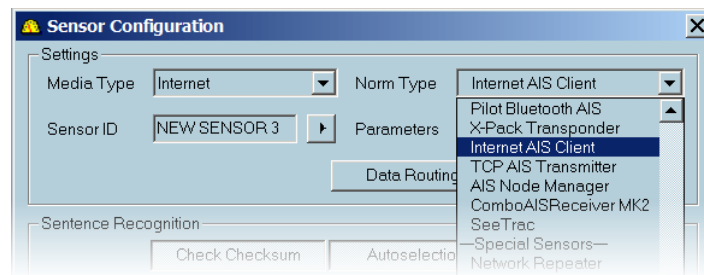

Start/Stop AIS data receiving

In ECDIS900 access to the target list window and activate or de activate the reception. Enter the login name and password when required.

After few seconds AIS targets are displayed on the chart.

SeaTrac

SeaTrac Tender Tracking

The SeaTrac Tender Tracking System is a stand-alone Radio Frequency Transmission System designed specifically for tracking watercraft as they operate around a Superyacht. The SeaTrac System operates without the requirement for land-based infrastructure. SeaTrac transmissions are without cost, and operate on either US or European license-free frequency bands. Dedicated NMEA sentence allows close Target or Tenders to be tracked around the own ship. Different alarm can be setup target per target.

- SeaTrac configuration in ECDIS (see "*SeaTrac configuration*" on page 149)
- SeaTrac display in ECDIS (see "*SeaTrac target display*" on page 150)

Alarms

There is 2 types of SeaTrac targets alarms:

- SeaTrac external alarms (see "*SeaTrac external alarm*" on page 150).
- SeaTrac internal alarms (see "*SeaTrac internal alarm*" on page 150).

SeaTrac configuration

Create dedicated special sensor **SeaTrac** is created in Sensor Monitor.



Total 5 targets:
 [59°01.0N;010°00.0E] 1
 [59°02.0N;010°00.0E] 2



SeaTrac target display

1. Right click on the **Target Table** button to open SeaTrac tender tracking dialog.
2. Toggle ON **Display tenders on the chart** to display targets (the default state is OFF).

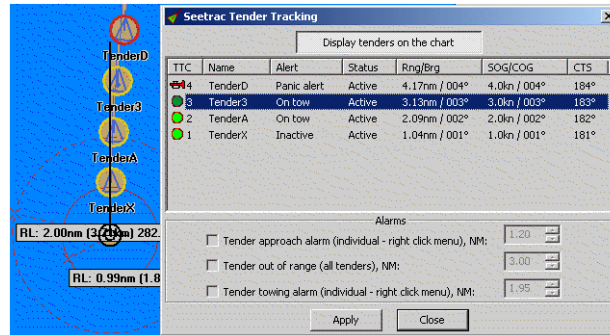

Target are displayed as AIS target except size of shape is fixed, and with .

- yellow circle around target shape (no alarm)
- red blinking circle together with Horn icon in TTC column (if alarm)
- Track available by right click menu for each target.

SeaTrac external alarm

This alarm is raised up by the Tender itself through NMEA when Alert field is setup to Panic alert (see example above for TenderD when no internal alarm is activated, refer to "SeaTrac target display" on page 150).

SeaTrac internal alarm

Three types of alarms can be activated regarding distance from own ship to Target.

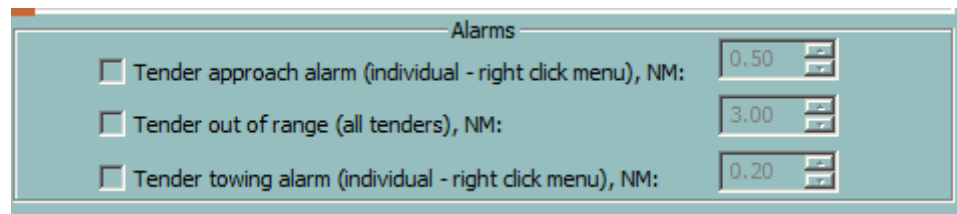

The box should be checked to get given alarm, and Distance threshold adjusted.

But in addition, for Tender approach and Tender towing, alarm should be activated target by target. Right click menu option **Activate** or **Deactivate**.

For each target, track can be display, same menu, option **Show track display**.

Tender approach alarm for TenderX

(alarm if Range < Distance)

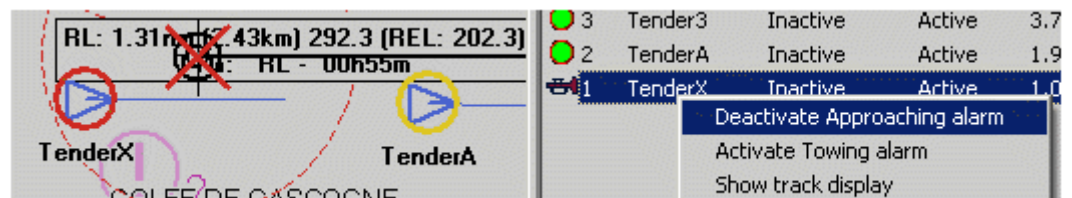

Tender out of range alarm for Tender3 and D

(Alarm if Range > Distance)

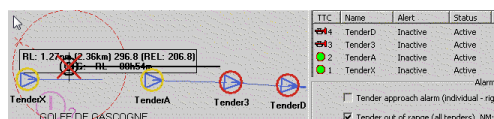

Tender towing alarm for Tender3

(Alarm if Range > Distance)

The screenshot shows a radar display on the left with a target at 24nm (2.30km) 302.2 (REL: 212.2) and a bearing of 00h52m. Three tugs are visible: TenderA, Tender3, and another Tender. A table on the right lists their status and alert settings.

TTC	Name	Alert	Status
4	TenderD	Inactive	Activ
3	Tender3	Inactive	Activ
2	Tende	Activate Approaching alar	
1	Tende	Deactivate Towing alarm	
		Show track display	

14

The Log book

During the process of its operation, ECDIS automatically maintains two different electronic logbooks:

- Voyage record.
- Twenty four hours logbook.

The voyage record stores every two hours the position, speed and course of the ship for half a year.

→ **Note:** This logbook is copy protected and cannot be deleted.

The twenty-four hours logbook records both navigational events and system events. It is also possible for the navigator to make manual entries in the logbook.

The logbook entries are divided into 24 hours. Automatically at 24.00 hours each day the current logbook is closed and stored in the logbook database and a new one created.

Recorded events include:

- Ship position, course and speed
- Chart in use together with the scale and central point of the screen
- The GPS position offset
- Route events (Active route and waypoint)
- Target events: creation, position, and deletion
- Target positions
- AIS target position, name and status
- Triggered alarms
- Acknowledged alarms
- Manual event
- Manual plotting (Navigation Editor)
- Position fixes are displayed in the tabular form. Other navigational objects created by user are visible while replayng data only.

The logbook window lists all entries of the current logbook (see "*Displaying the logbook*" on page 152) and allows printing (see "*Print*" on page 155) and to replay historical logbooks which have been first loaded (see "*Loading a logbook*" on page 154).

Logbook settings

It is not allowed to stop the logbook recording, but you can set the following parameters:

- Automatic deletion – no less than 90 days.
- VDR parameters
 - Socket to send
 - IP address for VDR

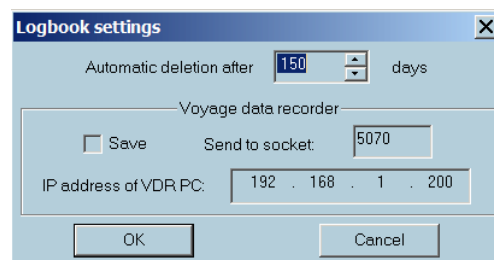

Displaying the logbook

Select the Logbook tool on the toolbar to display the logbook window and list the entries of the current twenty-four hours logbook. It is now possible to print the logbook, load an historical book and replay it.

Press the **VDR replay** button to replay recorded data from VDR recording.



Time (UTC)	LAT	LON	Event type	Comment	COG	SOG	HDG	STW	Range	BRG
00:00:13	42 04.095N	070 47.688W	Ship watch	Cell: US4MA13M.0...	180.00	3.5	300.50	3.5	-	-
00:00:13	42 04.095N	070 47.688W	-	Activate route Sce...	-	-	-	-	-	-
00:00:43	42 04.066N	070 47.688W	Ship watch	Cell: US4MA13M.0...	180.00	3.5	300.50	3.5	-	-
00:01:13	42 04.036N	070 47.688W	Ship watch	Cell: US4MA13M.0...	180.00	3.5	300.50	3.5	-	-
00:01:43	42 04.007N	070 47.688W	Ship watch	Cell: US4MA13M.0...	180.00	3.5	300.50	3.5	-	-
00:02:13	42 03.979N	070 47.688W	Ship watch	Cell: US4MA13M.0...	180.00	3.5	300.50	3.5	-	-
00:02:43	42 03.949N	070 47.688W	Ship watch	Cell: US4MA13M.0...	180.00	3.5	300.50	3.5	-	-
00:03:13	42 03.920N	070 47.688W	Ship watch	Cell: US4MA13M.0...	180.00	3.5	300.50	3.5	-	-
00:03:43	42 03.890N	070 47.688W	Ship watch	Cell: US4MA13M.0...	180.00	3.5	300.50	3.5	-	-
00:04:13	42 03.862N	070 47.688W	Ship watch	Cell: US4MA13M.0...	180.00	3.5	300.50	3.5	-	-

Each entry in the logbook is defined by the following attributes:

- Time
- Position (Latitude and Longitude)
- Event type
- Comment
- Other parameters depending on the event type.
- COG (Course over ground)
- SOG (Speed over ground)
- HDG (Heading)
- STW (Speed through water)
- Range
- Bearing

The entries are not editable, however you can sort the list by Time or Event type clicking on the relative column headings.

→ **Note:** The comment field contains information about the event. Together with the position of the ship the chart in use and the position offset is available. To display the full text, move the cursor onto the comment field and a small window will display the information.

Voyage record

To display the voyage record, press the button **Load** and select the file called using the following data format: **MM_DD_YYYYV4.lgf**.

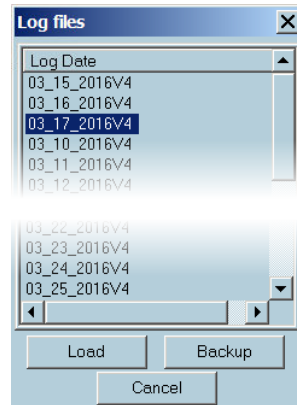

New log entry

In case of a special event, the operator can record the event in the logbook manually.

1. To enter a new record in the logbook press the New Logbook record button
2. Enter details via the keyboard and click OK.

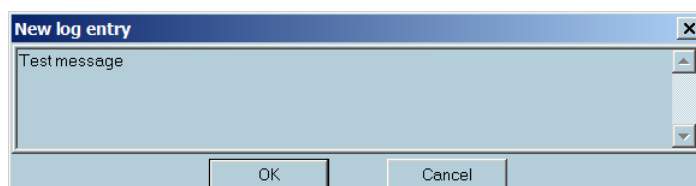

3. The new entry is added to the Logbook with time and location stamps.

Loading a logbook

Click the Load button to open the Log files dialog. The current logbook is closed every day at 24:00 hours and stored in the logbook database. A logbook is defined by a name, which is by default the date, and can be loaded from the database to be displayed and replayed.

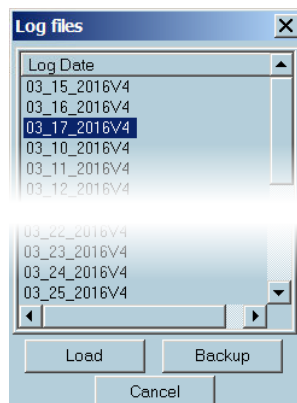

The loaded logbook will be shown in the logbook window, replacing the current logbook. When unloaded, the current logbook is re-displayed in the window.

Backup a logbook

Select the logbook name, push the button **Backup** and select the folder in which the logbook will be stored.

Replay

This function allows replaying exactly the main events which occurred during the navigation, in particular ECDIS loads and scales automatically the charts as they were and triggers and acknowledges alarms as it has been done during the voyage.

To initiate replay click on the **Replay** button in the **Log** window.

Warning: The replay function must be used carefully, preferably only when the ship is in harbor. During replay all navigation functions are deactivated, the ship is no longer monitored and the logbook recording is suspended.

The Log replay window allows the user to control the replay.

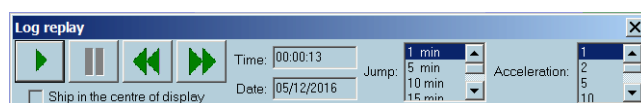

Start replay

- To start the replay click on the Start Replay button.
 - By default, the start time for replay is the time of the first logbook entry.
 - To suspend replay click the Suspend button
- **Note:** During replay most of the navigation functions are available, however the route planning and monitoring functions are not enabled. During the replay the chart is automatically loaded, scaled, and scrolled, and the logbook window scrolls automatically to display the replayed data.

Adjusting the replay starting time

Three different methods are available:

- Use of the Backward and Forward buttons for scrolling the logbook adjusting the start time.
- One click of a button will adjust the time by one Jump step.
- Click in the text box time, select the appropriate field, and enter the desired value .

- In the Logbook window, before starting the display, double click on the line you want the logbook to start.

Jump step

The size of the Jump step, the amount of time to move for each click of the Backward and Forward buttons, can be adjusted by use of the up and down arrows.

- **Note:** If the recording track function is active when rewinding or jumping, the track recording will be stopped. To restart recording the track during the replay, it is necessary to activate the track recording function again

Acceleration

You can choose the acceleration rate for the display. Adjust the rate with the Up and Down arrows.

The acceleration value of 5 provides replay of real time multiplied to 5.

Print

Click the **Print log** button on the Log dialog box and the Notepad will be displayed showing the content of the logbook.

```

05_12_2016V4.txt - Notepad
File Edit Search Help
Chart system log (v 4.0).
Date: 05/12/20
Start time: 00:00:13
Time      LAT      LON      Event type      COG
00:00:13  42 04.095N  070 47.688W  Ship watch      180.0
Comment: 00:00:13  Lat = 42 04.095N  Lon = 070 47.688W
Activate route Scenario-I-Test1-LOOP
00:00:43  42 04.066N  070 47.688W  Ship watch      180.0
00:01:13  42 04.036N  070 47.688W  Ship watch      180.0
00:01:43  42 04.007N  070 47.688W  Ship watch      180.0
00:02:13  42 03.979N  070 47.688W  Ship watch      180.0
  
```

- **Note:** The Notepad application gives the user all possibilities to save the file, change the document presentation and to search through the data.

New logbook record

To enter a new record in the logbook, click on the **New logbook record** icon.

For a detailed overview of this procedure, see "*Event*" on page 153.



15

Capture screen client

Capture Screen Client is a software for grabbing PC screen image and sending the image data to the network using TCP/IP protocol. It can be used as a part of ECDIS or RADAR software.

The usual receiver of the captured image is VDR (Voyage Data Recorder). Capture Screen Client supports UDP as TCP transmission.

For UDP transmission, sending the image data using multicast protocol is also supported.

The requirements for UDP protocol (protocol, IP addresses, ports) are described in IEC 61162-450 edition 1.

The demands to TCP protocol (protocol, IP addresses, ports) are described in IEC 62388.

For more details, refer to the Capture Screen Client User Manual.

16

Master bridge assistant (MBA)

MBA is an ultimate all-in-one solution for ship owners and mariners, offering a cost-effective and easy-to-use solution. MBA is designed to cover the needs of the navigator to maintain electronic charts and paper chart portfolio, publications and the need of the ship owner to monitor and control the costs. It is a module-based software which can be tailor-made through the activation of different modules available to fit the mariner and ship owner needs and requirements.

ECDIS900 users with MBA can enjoy the benefit of automatic data synchronisation. This integration gives even the most experienced navigator great advantages in management of chart handling and updates.

→ **Note:** Customers can obtain support by contacting Navico at chartservice@maris.no.

For more information, refer to the **MBA Operator manual**.

17

NAVTEX

ECDIS900 can manage data received from different Navtex receivers. Only Navtex receivers are able to send data on serial line can be interfaced to MARIS ECDIS900.

When MARIS Navtex module is installed two applications are launched:

- MARIS Navtex Server
- MARIS Navtex Inbox

Messages received from the Navtex are automatically and continuously processed by the MARIS Navtex Server application.

The messages are sorted by type and displayed in the application MARIS Navtex Inbox.

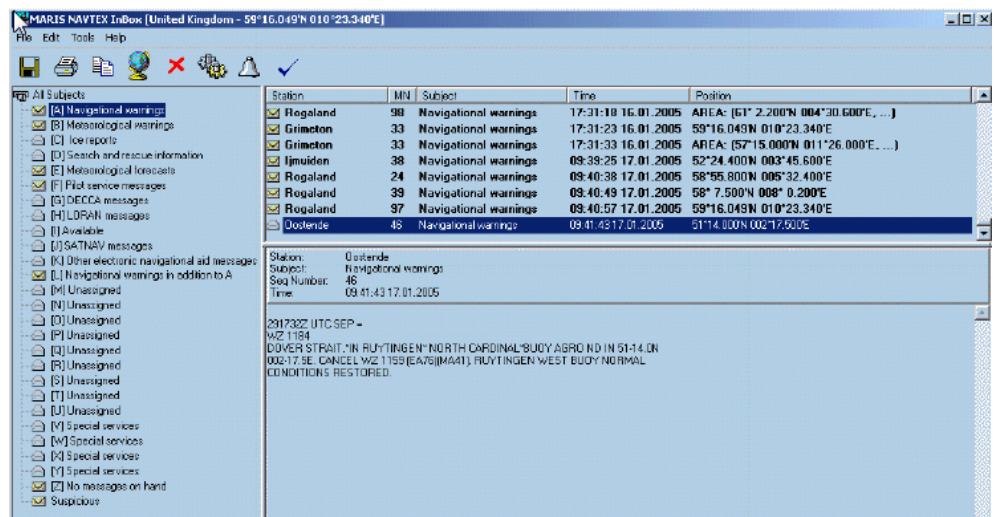

Graphical display

For each geo referenced message an icon or several linked icons are displayed on the ECDIS charts.

Click in the icon Navtex located in ECDIS900 Alarm panel to access to the Navtex window.

This window lists the messages which are currently displayed on the chart. When the chart is scrolled or zoomed the content of the window may change.

The display of the messages on the chart is activated by the check box Display and controlled by the parameter With scales above.

Set the values for time of life and distance for messages.

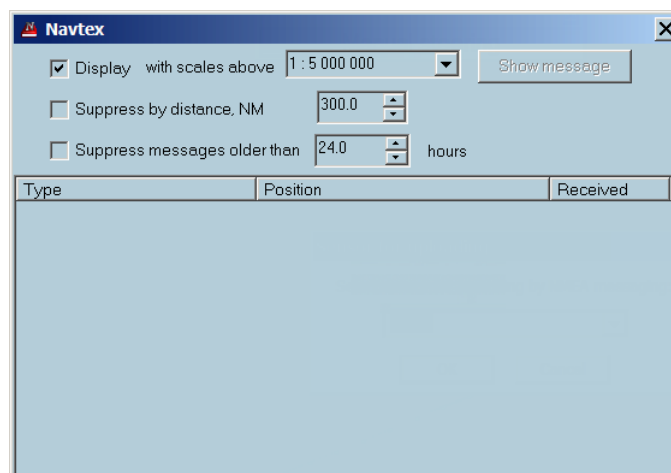

When the NAVTEX is activated, the MSI graphical symbols indicate the messages on the chart. The symbols are displayed when the scale in use is bigger than the selected scale.

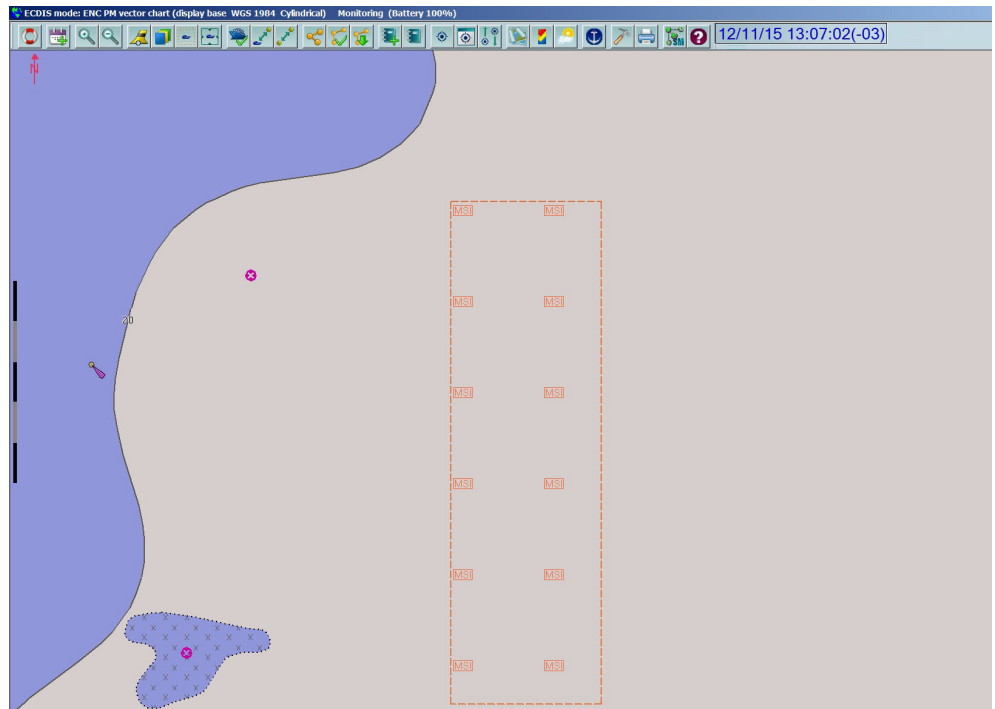

To activate NAVTEX Inbox, right click on the icon or on the node of the area. The Inbox appears, the message is highlighted.

Access to Navtex message

In ECDIS double click on the message listed in the window to display the full text message in the application MARIS Navtex inbox. Alternatively select the message and push "Show message" button.

From the chart right click on the icon and activate the menu.

Message status

A message is either read either unread. Closed envelop icon displayed in front of the message and bold characters shows unread messages.

The icon Navtex in ECDIS900 is either opened either closed .

Closed icon means that unread Navtex messages exist on the screen. Opened icon means that all messages from the area have been read.

18

Editors overview

THE ECDIS has been designed by navigators and for navigators to help the user in his everyday tasks in order to increase safety of navigation. The ECDIS therefore provides, in addition to the standard ECDIS functions described in this document, powerful tools allowing the user to work on electronic charts in the same way as on paper charts.

The user may:

- Draw bearing lines, parallel or perpendicular lines and range circles just as he did with pencil, compass and a ruler on the paper chart.
- Add temporary text information to the chart.
- Maintain the dead reckoning in case of GPS failure by manually plotting D.R. or Radar positions.
- Add user data information to the chart such as wrecks, survey areas, marks etc.
- Manually update the S57 chart database by deleting, moving or adding chart objects.

→ **Note:** The 'Tools Panel' contains different panels depending on the the ECDIS configuration: the Editors panel is always present, the Radar panel is available only when the optional Radar Kit is installed.

General tools

General tools refers to both NE and OE objects while specific tools refers to either NE (those accessible in user's data panel area and dedicated NE) or OE.



- The tool **Select OE objects** allows selecting OE objects.
- The tool **Select NE objects** allows selecting NE objects.
- Then the selection can be moved or deleted.

The tool **Delete selected object** delete the selection of NE or OE objects.

The tool **Show/Hide objects list** displays the list of objects currently loaded. Double click on the object to center the chart on the object.

Select the object and push the key **Del** to delete the object.

Selection

A selection is a collection of selected objects of the same type, NE or OE.

To make a selection of NE objects press the button "Select NE object", click on the chart and drag the mouse to define a rectangle.

Use the tool "Select OE objects" to select OE objects.

Other methods to select objects

- Select a single object: click on the object.
- Select two or more objects (Selection containing several objects): click on each object whilst keeping the <Shift> key pressed.
- Activate the menu Select All Object Editor from the menu Edit.
- Activate the menu Select All Navigation Editor from the menu Edit.
- Activate the menu Select All Alarms objects from the menu Edit.

IMPORTANT selection and locked layer

When an OE object resides in a locked OE layer, that particular object is not selectable. For more information about layers see chapter OE - Layers.

Move the selection

- Move the cursor over one of the selected points and when the cursor changes to the hand shape, drag the whole selection to the desired position.
- When the cursor changes to the large arrow only the selected point will be moved.

Delete the selection

Select the object(s) and push the 'Delete' button





Other methods of deleting the selection:

- Press the **Delete** key.
- Select 'Cut' from the Edit menu.
- Select 'Delete all selected' from the Edit menu.

Edit menu

Undo Delete Object	Ctrl+Z
Cut	Ctrl+X
Copy	Ctrl+C
Paste	Ctrl+V
Paste to Position	Shift+V
Delete all selected	Del
Select all Object Editor	
Select all Alarm Objects	
Select all Navigation Editor	
Connect two polylines	
Order	▶
Change to Rhumbline mode	

Undo

Allows the most of the actions performed on NE or User's data objects to be undone.

When Undo is not possible, the menu is disabled.

There are up to ten levels of undo, meaning that the ten last functions applied on objects can be cancelled.

→ **Note:** The Undo function is applicable only on NE and OE functions

Cut/Copy

Delete or Copy the selection and copy it to the clipboard.

Paste

Copy the selection added to the clipboard to the active layer.

With NE objects, the selection is simply copied in the NE layer.

For OE objects the functions Cut/Copy/Paste are used to copy objects from one layer or one file to other one. See Chapter OE - Layers.

Paste to position

Select 'Paste to Position': the cursor changes and the selection will be pasted at the mouse click location. This function is equivalent to the move selection action performed with the mouse.

Delete all selected

Delete the Selection.

Select all object editor

Empty the selection and select all OE loaded objects that do not belong to a locked layer.

Select all alarm objects

Empty the selection and select all alarm objects defined by the user.

Select all navigation editor

Empty the selection and select all NE loaded objects.

Connect polylines

Select two polylines, activate the item Connect Polyline: the two lines are then connected.

Order

User's data objects loaded in the ECDIS are displayed with a priority controlled in two different and complementary ways:

Layers order: the files and the layers are displayed in an order defined by the user. See chapter OE paragraph Layers.

Inside each OE layer the user can control the order the objects are displayed.

The item menu 'Order' allows changing the priority of the display of the selected object by sending it 'to back', 'to front' or moving it one step forward or backward in the layer's list of objects.

→ **Note:** The function Order is applicable only on the active layer. To change the display priority of objects belonging to other layer the user must first activate the layer. See Chapter OE, paragraph Layer.

Switching to the rhumbline mode or Switching to the Great circle mode

Display all lines either in Rhumbline mode either in Great Circle.

Navigation Editor

Navigation editor overview

The Navigation editor gives the user the possibility of working with the electronic chart in the same way as with the paper chart:

- Preparation of a harbor arrival or a passage through a dangerous area by adding temporary information on the chart.
- Planning the route more safely by drawing restricted or dangerous zones.
- Manually plotting the position of the ship.



Information and objects plotted with the NE (Navigation Editor) are stored and presented in a special layer called NE layer that is displayed on the top of the electronic chart.

NE layer contains objects (lines, arcs, chart annotations, current information) that are temporary objects, displayed on the chart until such time as they are deleted.

The ECDIS does not allow the possibility of storing these objects to file and reloading them in the system on request.

The different objects available are:

- "*LOP Function*" on page 162
- "*Arcs*" on page 164
- "*Points*" on page 166
- "*Current Information*" on page 166
- "*Compass*" on page 166
- "*Polylines*" on page 166
- "*Parallel and perpendicular lines*" on page 167
- "*Chart annotation and caution*" on page 168

The Multi-plotting mode allows plotting several objects without having to select the plotting tool for each object (see "*Multi plotting mode*" on page 162).

Multi plotting mode

To plot an object requires:

1. Select the appropriate tool, Bearing line, Arc, Point...
2. Enter eventually additional information.
3. Click on the chart.

In the current plotting mode, the plotting tool is deactivated when the object is defined.

To plot other objects of the same type requires selecting the same tool for each object.

When the tool is selected with the right button of the mouse it remains active after the object is plotted and other object of the same type can be plotted on the chart without tool selection.

This facility is available for the Arc, Point, Polyline and Chart annotation.

To de-select the tool click again on the tool button or select another tool.

LOP function

This function is implemented according to **IEC 61174 edition 3**, and it allows using Line and Arcs in order to calculate a Fix Position (Using 3 or more Line or Arcs, or a Estimated Position, using 2 Lines or Arcs

1. Press the button "LOP/Clearing line" in the Console, Tools, Editor tab.



2. Select "Line of position bearing,degr " for a Line:
 - Enter bearing in degrees
 - Enter LOP label displayed on the map.

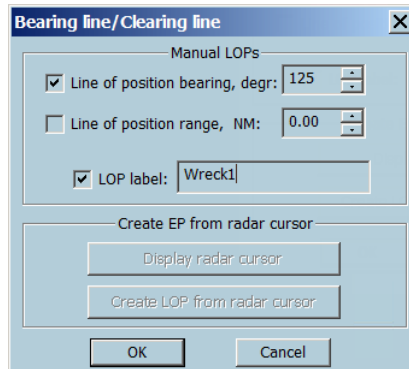

3. The cursor will change to a cross "+". Click on the bearing point and drag the mouse as far as is necessary. The time Stamp is saved and displayed.

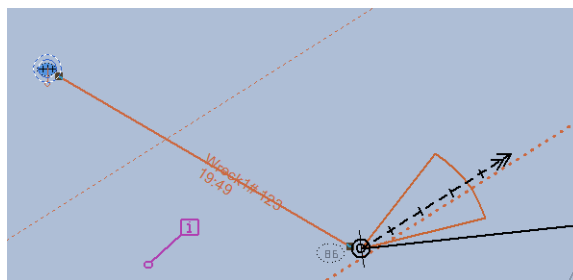

4. Select "Line of position, range,NM " for an arc:
 - Enter range in NM
 - Enter LOP label displayed on the map.

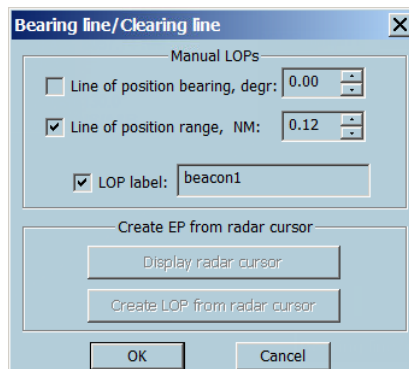

5. The cursor will change to a cross "+". Move the cross on the point center of arc and Click on the position.

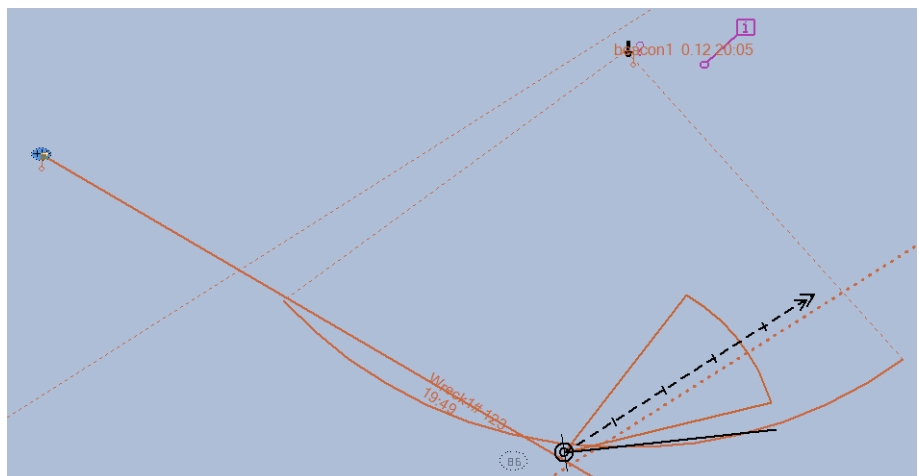

Object Modification

It is possible to adjust Lines or Arcs after creation:

- Use mouse cursor by drag or extend.
- Right click and open Properties dialog box, and adjust parameters.

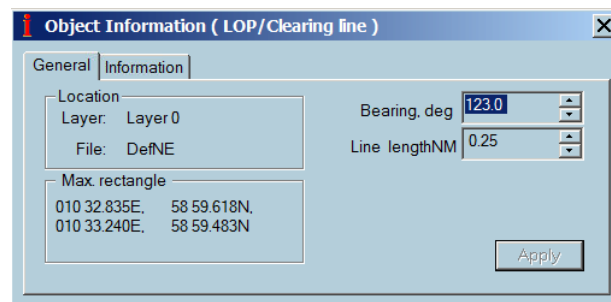

Calculate Position

Select 3 objects (or more) to get a FIX position from LOP.

(Use CTRL for multiple selection)

Here 3 lines are used.

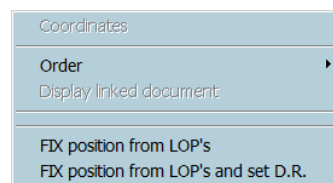

The FIX point is added.

Use Right click and Properties to get details.



Select 2 objects (or more) to get a "FIX position from LOP.

Here 1 line and 1 arc are used.

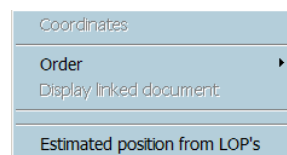

Option **Set D.R.**

Create the Fix point and select **D.R.** mode at the same time.

Selecting a bearing line

- Either click left button on the line.
- Either select the tool Selection with the left button of the mouse, click on the chart and drag the mouse: all NE objects included inside the rectangle are selected.

Deleting a bearing line

- Click right button on the line and activate the menu **Delete All Selected**.
- Select the line and press the key **Del**.
- Select the line and press the **Delete** button.

Arc

Plotting an arc

1. Press the Arc button, the cursor on the chart changes.
2. Click to plot the center of the arc, drag the mouse and click one time: the origin point of the arc is plotted. Move the mouse in the appropriate direction and click a second time to define the arc extremity.

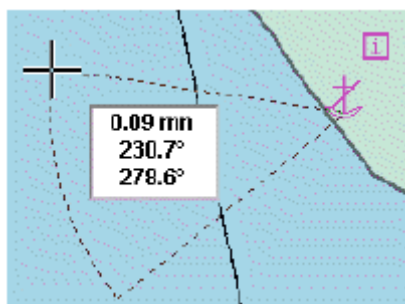

Modifying an arc

1. Select the arc, click on the center and drag the mouse: the center and the arc are translated.
2. Select the arc, click on one of the arc points and drag the mouse: the arc is modified in range and angle.
3. Click right button on the arc, access the menu Properties and modify position, radius, start or end angle.

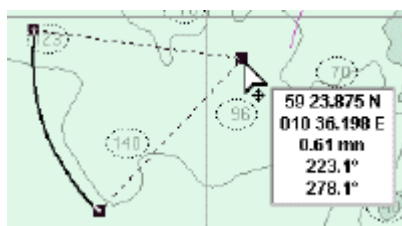

4. Click right button on the center, access the menu Absolute Coord and change the position of the point.

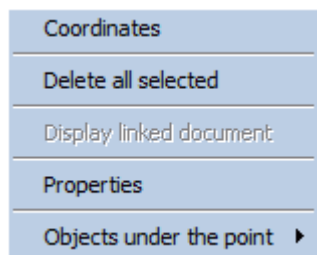

5. Click right button on one of the arc point, access the menu Absolute Coord and change the radius, start or end angle.

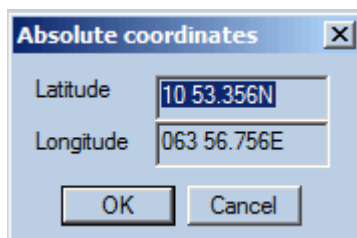

Deleting an arc

1. Click right button on the arc and activate the menu **Delete All Selected**.
2. Select the arc and press the key Del.
3. Select the arc and press the Delete button.

Tip: Double click on the tool **Arc** deletes all displayed arcs.

Point

The Point tool allows plotting isolated points on the chart in particular the positions of the ship calculated manually from bearing lines, Radar, Dead reckoning or Astronomical calculations.

→ **Note:** The plotted points are stored in the logbook and therefore displayed / hidden in real time on the chart during the replay of the logbook.

Plotting a point

1. Select the tool Point and click on the chart.
2. The ECDIS first tries to find an intersection point under the click between, two lines or a line and an arc. Then the co-ordinates of the plotted point are made equal to the co-ordinates of the intersection point.
3. If no intersection is found under the click, the co-ordinates are not adjusted.
4. In the Properties dialog, select the type of point and enter time and log information.

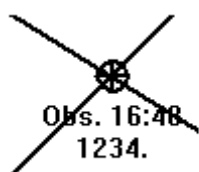

Modifying a point

1. Select the point, click on the point and drag the mouse to the new location.
2. Click right button on that point, open the dialog Properties and modify position, type of point, time or log values.



Deleting a point

1. Click right button on the point and activate the menu 'Delete All Selected'.
2. Select the point and press the key 'Del'.
3. Select the point and press the 'Delete' button.

Tip: Double click on the tool Point deletes all displayed points.

Current information

1. Select the Current tool.
2. Click on the chart and insert manually on the chart information about force and direction of the current at the time the ship will pass that point.



Delete Current Information

- Click right button on the current arrow and activate the menu Delete All Selected.
- Select the current and press the key Del.
- Select the current and press the Delete button.

Range and bearing calculation

1. Select the Compass tool to measure distance and bearing between two points.
2. To erase the information on the chart double click on the button.

Polyline

Plot a line

- Select the Polyline tool .
- A double click ends the line.

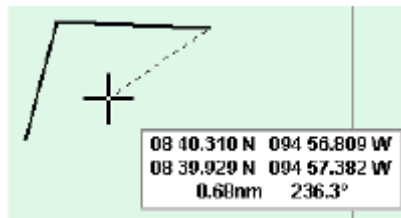

Modifying a line

Select the line and either move the entire line or a point of that line

- when the cursor has a hand shape the line is selected and moved according to the mouse movements.

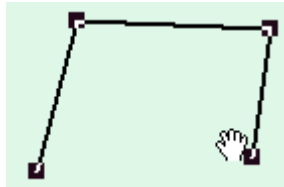

- otherwise the point is dragged

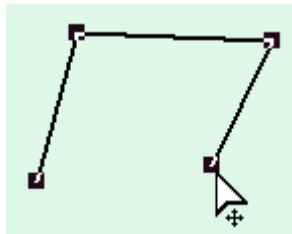

Change by keyboard the co-ordinates of one point of the line by clicking right button on the point and selecting Absolute Coord.

Add a point by clicking right button at the desired location on the line and activating the item 'Insert a point'. Other method: select the line, move the mouse at the desired location on the line and press the keyboard key I.

Delete a point by selecting the line, clicking right button on the point of the line and activating the item 'Delete point'. Other method: select the line, move the cursor on the desired point of the line and press the keyboard key D.

Split the line in two lines by selecting the line, clicking right button on the point of the line and activating the item 'Cut point'. Other method: select the line, move the cursor on the desired point of the line and press the keyboard key C.

Deleting a polyline

See paragraph Delete an ARC.

Parallel line

1. Press the Parallel line button.
2. Select a bearing line: the button Parallel line is then activated.
3. Select the tool, click and drag the mouse to define the length of the parallel line (control the distance from the selected line with the distance information drawn on the chart).

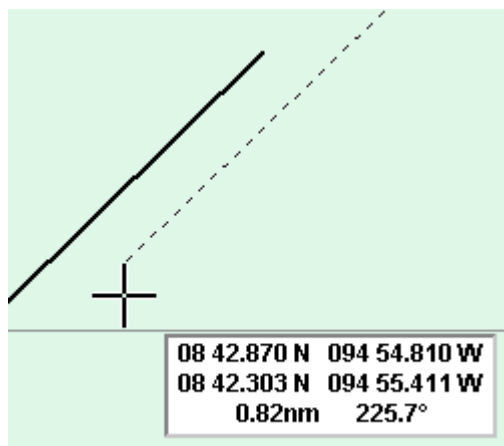

To modify or delete the line see paragraph Bearing line.
 Press the Perpendicular line button
 Same procedure as for the parallel line.

Chart annotation

Allow inserting text annotations on the chart.



VHF Channel 15

→ **Note:** to show the text on the chart toggle on the button Display in the Properties dialog of the Information point.

Deleting Chart Annotation

- Click right button on the Chart Annotation and activate the menu Delete All Selected.
- Select the Chart Annotation and press the key Del.
- Select the Chart Annotation and press the Delete button .

Tip: Double click on the tool Chart Annotation deletes all displayed Chart Annotations.

Object Editor

Object editor overview

User data consists of geographical objects such points, lines, areas, that are displayed on the chart to enrich it. The Object Editor (OE) allows plotting, importing, manipulating and saving user data.

Data are saved in files that can be loaded or unloaded on request. Each files contains 8 different layers called by default Layer 0,1,2,3,4,5,6,7 and the user can select in which layer he wants data to be stored.

Each layer may be shown or hidden, locked or unlocked and defined as visible between editable minimum and maximum scales.

This feature is extremely powerful because it gives the user the tools to build up its own user data charts in the same way than vector chart databases are built. For instance, a general layer, visible in small scales, could include synthetic description of objects while a harbor layer could contain the full description of the objects.

Plotting objects

The different available object types are:

- Polyline
- Surface
- Circle
- Arc
- Isolated point

- Text

Select the appropriate Plotting tool.



Place the cursor on the chart at the required position and click.

To end a line or close an area, double click when plotting the last point or select another tool.

To plot a circle or an arc, click, and drag the cursor with the mouse button down.

New object by keyboard

To create an object by keyboard:

1. Select the object type (Polyline, area...).
2. Move the mouse on the chart area.
3. Press the key "O".
4. Enter the co-ordinates of the point (s) and object parameters (Radius...)

Multi plotting mode

In a normal plotting mode, the plotting tool is deselected after the object is plotted on the chart.

To be able to plot several objects of the same type without having to activate the same tool each time, select the tool with the right mouse button. Then deselect the tool by selecting another tool or pressing again on the tool button.

Object properties

A newly created object is drawn on the chart with the selected display attributes shown in the bar.



Choose different default display settings by clicking on the appropriate button, Line type or width for the lines or icon type for the isolated point.

In the same way change the display characteristics of a selected object by choosing different display attributes after the object has been selected.

Control the display priority amidst the objects of a same layer with the Order menu.

Files

Data that are plotted on the chart are stored in the active layer of the active file: the active layer and file names are displayed on the top of the OE area.

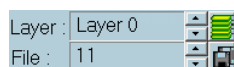

By default the user data are saved in a layer called Layer 0 in a file called Untitled but the user can select at any time other active file and layer with the files and layers management dialogs activated by the buttons 'Copy' and 'Layers'.



The file management system allows selecting the active file, to load or unload a file or a set of files, to save or save as the files, to create a new file and to back up loaded files on floppy disk. Import allows converting files with specific format.

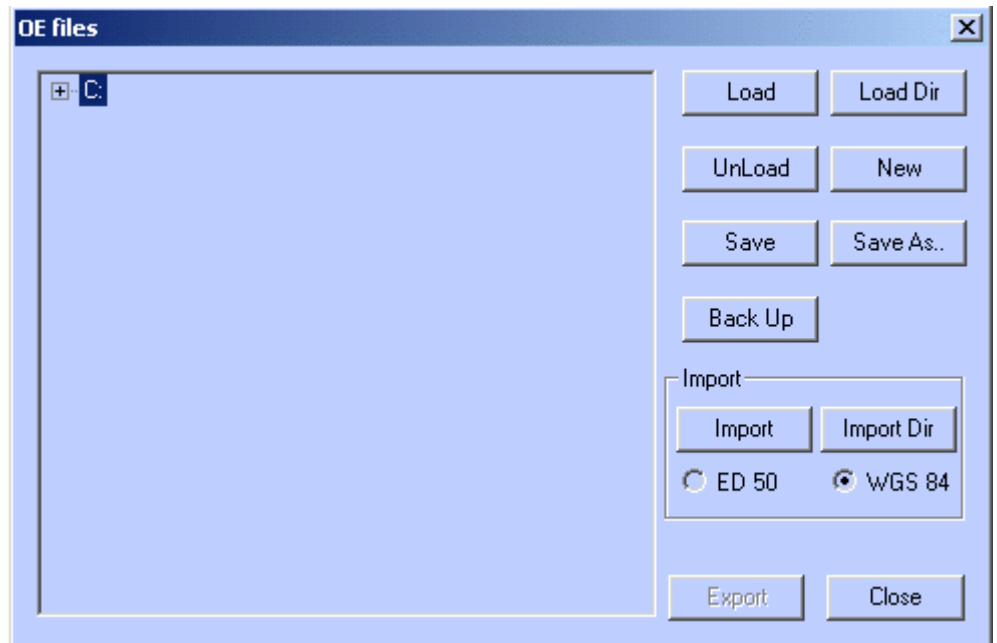

Active file

There are three ways of selecting a new active file:

- To make active a file that is already loaded in the system, use the small arrows next to the file name until the right file's name is displayed.
- To make active a file that is not loaded, press the button 'Copy', access to the file selection dialog, press the load button and select the file to be loaded: the selected file read from the hard disk will become the active file.
- To make active a file that is already loaded in the system, press the button 'Copy', access to the file selection dialog and double click on the file's name.

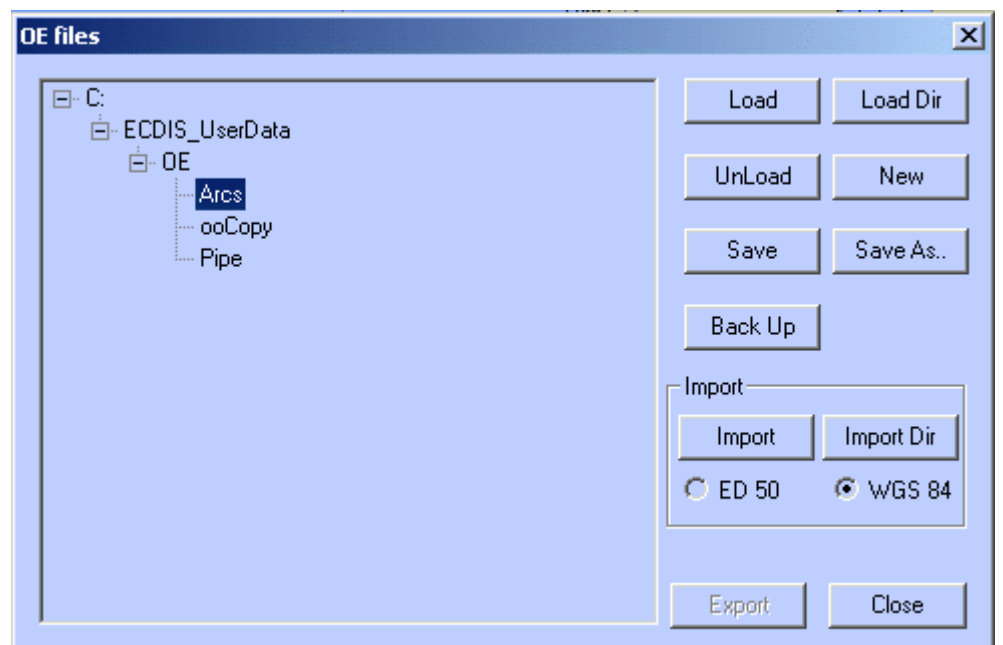

Load/Unload files

- To load a file, push the button Load and select the file name in the appropriate folder.

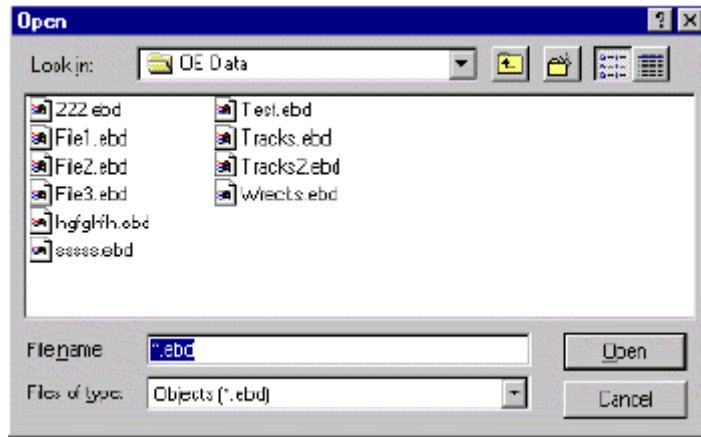

- To load simultaneously several files stored in the same folder, push the button Load Dir and select the folder containing all files.

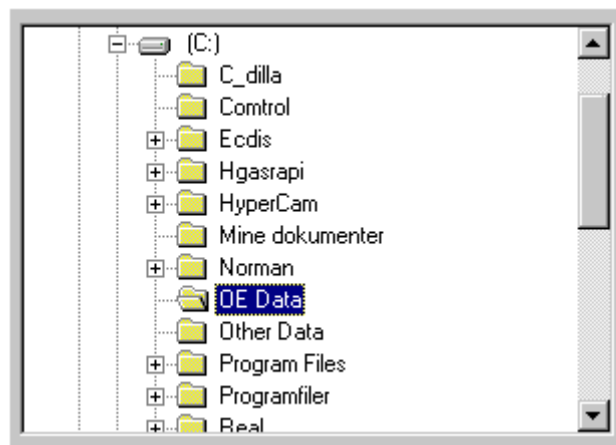

- To unload a file or a set of files belonging to the same directory, select a file or a directory name and press Unload. The file or all files contained in the selected directory will be unloaded.

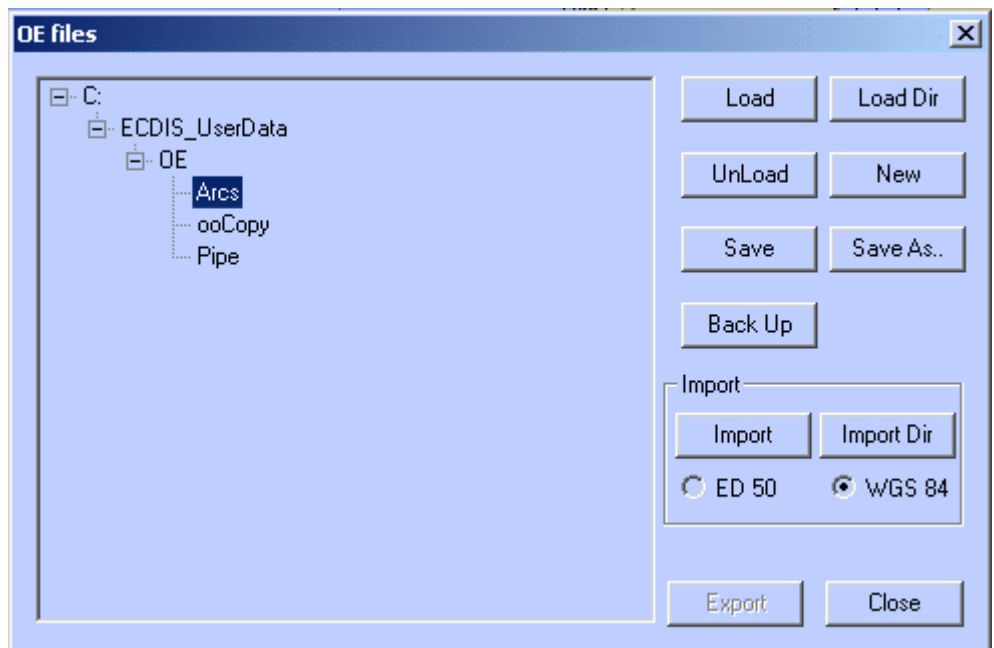

Save files

When a file is modified it is not automatically saved on hard disk. To save the modifications, activate the file management dialog, select the file and press the button Save or Save As to save the file with a different name.

→ **Note:** When a directory is selected, all files of that directory are saved.
The function Save As is not applicable on directories.

Create a new file

Press the button New to create a new empty file. By default this file is called Untitled and contains five layers called Layer 0, ..., Layer 7.

Untitled is a reserved name and the file Untitled cannot be saved with that name. A new name has to be entered to store the newly created Untitled file on hard disk.

Back up files

To back up files on a memory stick, select a file's or a directory's name and press Back Up. The file or all files contained in the selected directory will be copied on the memory stick.

Import file

The ECDIS can convert different types of files with proprietary format and display the data as object editor data.

The ECDIS is compatible with Statoil data stored in files with extension .xy (pipelines), .dat (Platforms) and .txt (Fixtar).

Layers

Each file contains 8 layers and the user selects the layer to store its data in.

Each layer has a display priority and the layer list control in which order the layers are displayed: the first layer of the list is displayed the first.

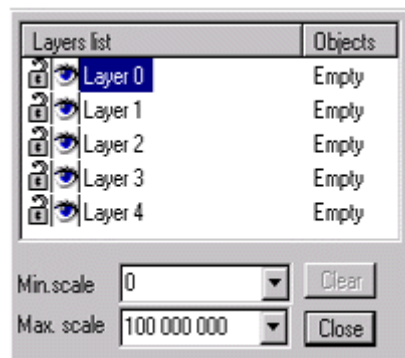

Each layer's name can be changed and the order the layers are displayed can be adjusted. Moreover, each layer can be made locked or unlocked, shown or hidden and minimum / maximum scales can be edited, meaning that the layer is displayed only when the chart scale is comprised between these two scales.

User's data can be copied and pasted from one layer to another.

Layer's name

Changing name of the layer is done by clicking on the name once and entering the new name.

Layer Display Priority

In the list, the layer "General" is displayed first, Approaches in second etc.

To modify the display priority select a layer name and drag it up or down the list.

Lock/Unlock

Click on the locker on the left side of the list to make the layer locked. After the object is locked it is not allowed to edit.

Show/Hide

Click on the eye button on the left side of the list to hide the layer locked. Then the layer is made invisible and locked.

Minimum/Maximum scales

In the picture the layer General is visible when the chart scale is comprised between 1 / 100 000 000 and 1 / 8 000 000 and the layer Harbor when the scale is bigger than 1 / 500 000.

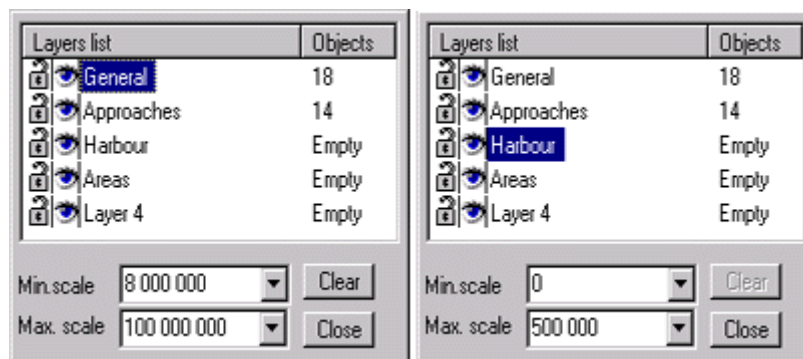

→ **Note:** When the chart scale is not within the scale limits of the active layer it is impossible to plot any object on the chart. For instance, if the current chart scale is 1/1 000 plotting a point in the layer Harbor is impossible. Therefore to be able to plot a point change the chart scale or the active layer.

Copy/Paste

To copy objects from one layer to other one, make a selection of objects (hide eventually other layers to make the selection easier as done in the picture below), activate the item Copy from the menu Edit, activate the destination layer and Paste item.

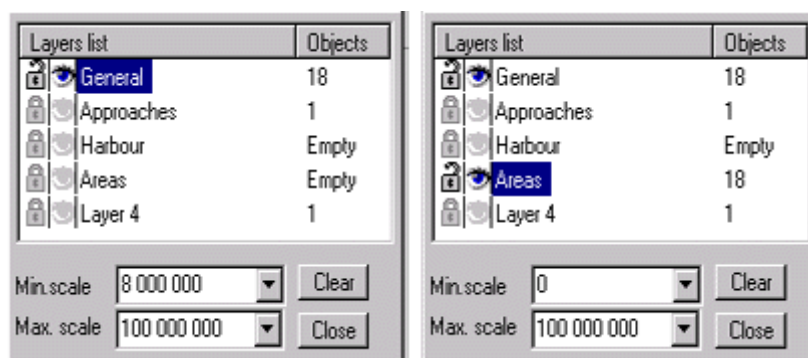

Clear

Select a layer and push the button Clear: all objects of that layer will be deleted.

Display attributes

A newly created object is drawn on the chart with the selected display attributes shown in the bar.



Choose different default display settings by clicking on the appropriate button, Line type or width for the lines or icon type for the isolated point.

In the same way change the display characteristics of a selected object by choosing different display attributes after the object has been selected.

Control the display priority amidst the objects of a same layer with the Order menu.

Colors

In the color dialog, click left button on the desired color to set the color for the lines and right button for the color of the filling patterns (area, circle or arc).

Line Width

Select in the line width menu the line width for both lines and areas.

Line Type

Select in the line type menu the line type (plain, dotted etc.) for both lines and areas.

Pattern

Select in the pattern menu the pattern to be used to fill up areas, circles or arcs.

Icon

Left click and select in the list the standard icons to be used for isolated point.

→ **Note:** Right click in the button displays the list of official S57 icons making possible to manually update the chart.

Character style

Select the character type, style and size to be used for the free text displayed on the chart.

Modifying display attributes

A newly created object is displayed with the current display settings, color, line width or icon type.

To change the way an object is drawn and change its display attributes:

- Select the object.
- Select other display attributes with the setting tools.

For example:

- To change an isolated point icon, select the point and choose another icon from the icon list.
- To change the filling color of a circle, select the circle, click in the color setting button and choose the new color with the right button.

Display priority

The objects of the same layer are drawn in the order which they have been created. But the display priority between two objects can be modified: for example when a plain colored area, plotted after an isolated point, hides this point. To make it visible, select the area, click right button on that area, activate the menu Order and select the item To back.

To Back sends the object at the end of the object list of the layer while Back One moves back one step the object in the list.



Properties

Each OE object has different attributes depending on its type and there are represented in the properties dialog.

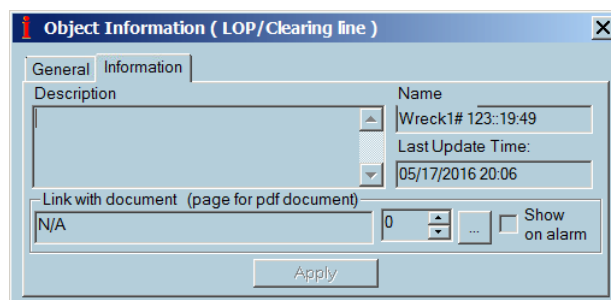

Access the **Properties** dialog by clicking right button on the object.

Enter or consult free text information concerning the object in the information panel.

→ **Note:** When description field is filled in, the information is displayed on the chart in a prompt window when the cursor is located on top of the object.

Edit object attributes in the General tab. The attributes depend on the object type.

An example of circle properties: the position of the center and the radius are editable.

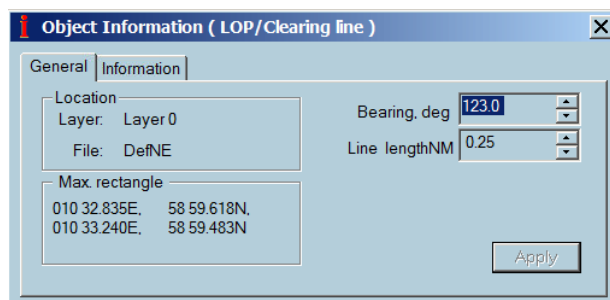

Link with additional information

An object can be linked with a file containing text, picture, video but also PDF file.

In object properties dialog select the file linked with the object.

The information contained in the file is be presented in the application used to create the file. For example a PDF file will require Acrobat Reader to be installed on the hard disk to be able to display the information.

The file can be displayed in two different ways:

- Manual: right clicking on the object and select the item menu **Display linked document** (name of the document).
- Automatic: set the **Show on alarm** attribute on, and the object triggers a user alarm.

Modifying objects

Each OE object loaded in the memory can be selected , deleted and moved to other position.

- A new point can be added to a line or to an area.
- A point of a line or surface can be deleted or moved.
- A line can be closed and transformed in an area or cut in two pieces.
- Two lines can be connected.

→ **Note:** All modifications applied on objects as described below can be cancelled with the item Undo from the menu Edit. See paragraph Edit Menu.

Selecting objects A selection is a group of selected OE objects.

Select one object: click on time on the object or on one of its edge.

Select two or more objects (Selection containing several objects): click on each object maintaining the keyboard key Ctrl down.

Activate the menu Select All OE objects from the menu Edit: all loaded objects are added to the selection.

Use the tool "Select OE objects" to select OE objects.

→ **Note:** selection and locked layer. When an object belongs to a locked layer that object is not selectable. For more information about layer see paragraph Layers.

Delete objects

Select an object and push the button. If several objects are selected, the entire selection is deleted.

Other methods to delete a selection of objects:

- Press the Del key.
- Activate the item 'Cut 'from the menu Edit.
- Activate the item 'Delete all selected' from the menu Edit.

Modify position

Object location

To change the object's position on the chart, select it, move the cursor on that object near a selected point and when the cursor has a hand shape click and drag the object.

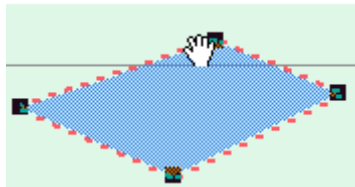

Point's coordinates

When the cursor has the following shape the point under the click will be moved and then the object shape modified.

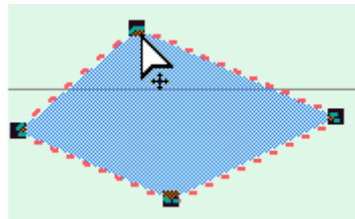

To modify the coordinates of a point by keyboard, select the object, click on that point and activate the item Absolute Coord.

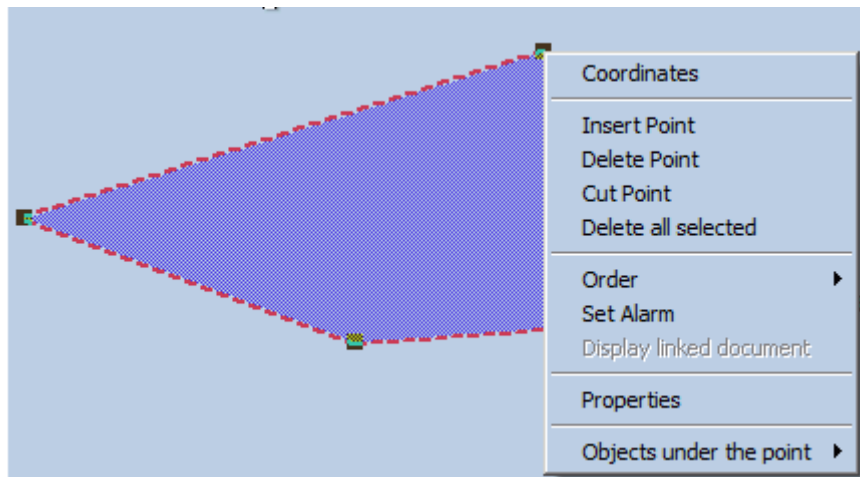

→ **Note:** The dialog **Absolute Coord** does not allow modifying the position of the center of a circle. To modify it by keyboard access the **Properties** dialog of the circle and enter the new position.

Other operations

Insert a point in a line or an area

Click right button on the line / area at the desired location and activate the item 'Insert Point'.

Another method:

Select the line / area, move the mouse at the desired location on the line / area and press the keyboard key I.

Delete a point in a line or an area

Click right button on the line / area on the point and activate the item 'Delete Point'.

Another method:

Select the line or the area, move the cursor on the point and press the keyboard key D.

Cut a line in two

Click right button on the line / area on the point and activate the item 'Cut Point'.

Another method:

Select the line or the area, move the cursor on the point and press the keyboard key C.

Close a line

Activating the item Close Polyline from the menu Edit on a selected line transforms the polyline in a surface.

Connect two polylines

Select two polylines and activate the item Connect two polylines from the menu Edit to join the two lines.

S57 manual update editor

The ECDIS supports the automatic updating of S 57 data as described above but also allows the data to be manually corrected. The change can be visualized and do not restrict the ability of automatic updating.

There are three different ways of changing objects by manual updating:

- Deleting and annotating objects
- Modifying objects
- Inserting objects

All manual updates applied in the cell are stored in a log file and can be review on request.

In ECDIS the modification of objects is limited to adding text information or moving objects. The latter is implemented as deleting the object and afterward inserting a copy.

The ECDIS provides functions to cancel or withdraw manual updates and to query objects, which have been inserted by manual updates.

A manual update always has effect on only one particular cell. This cell has to be assigned to the view.

Select objects

1. Click on the object with the right button and activate the menu **Manual update**. The selected object is highlighted in the chart.
2. Select the type of object to be selected under the click: point or line area.

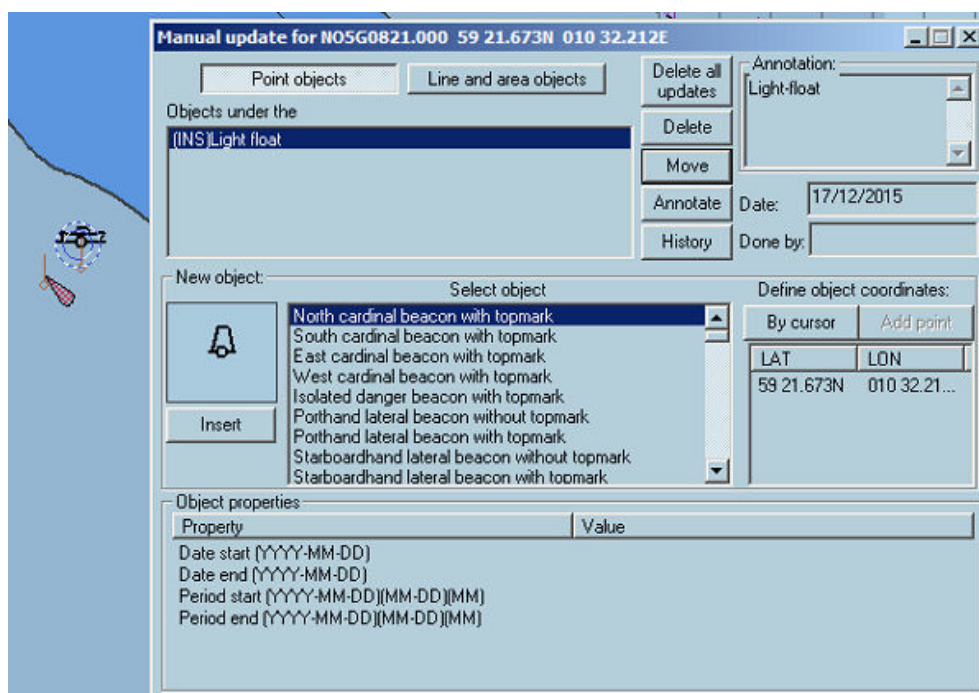

Delete and annotate objects

To delete an object in the sense of manual update:

1. Select the object.
2. To delete only one component, select the element of the object and press **Delete**. A deleted object is highlighted on the chart as shown in the picture.

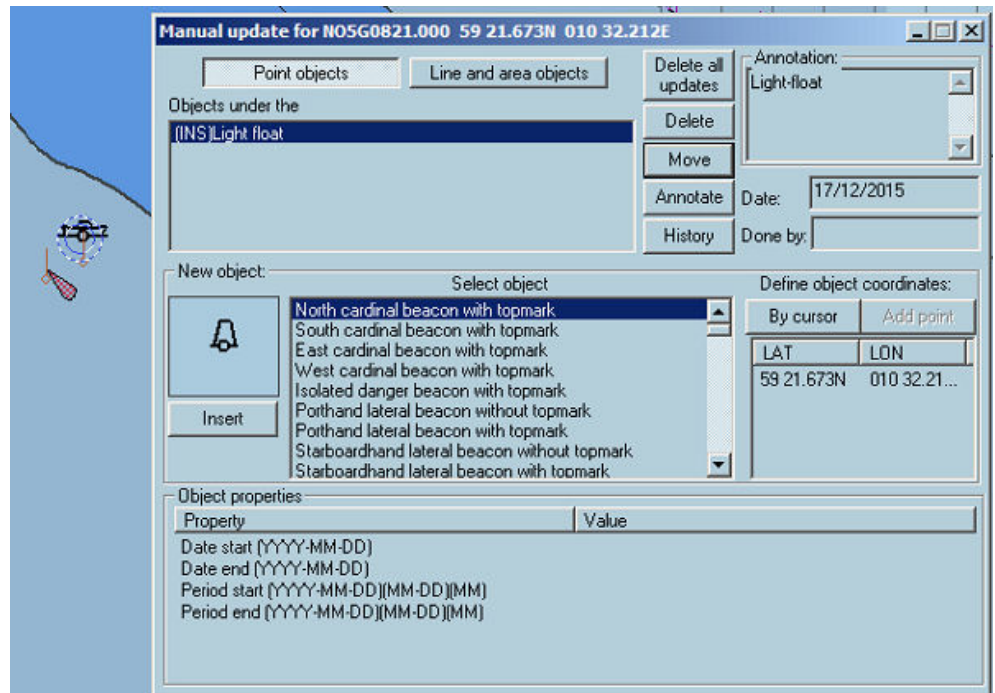

To annotate an object, i.e. to add text information to the object:

- Select the object and one component.
- Enter the text and press the button **Annotate**.

Insert object

Insert point objects

1. Click right button on the chart at the appropriate position and activate the menu **Manual update**.
2. Select the object type: point object.
3. Select the type of point object you want to insert.
4. Set the date values if it is necessary.
5. Adjust by keyboard the coordinates of the point and press **Insert**.

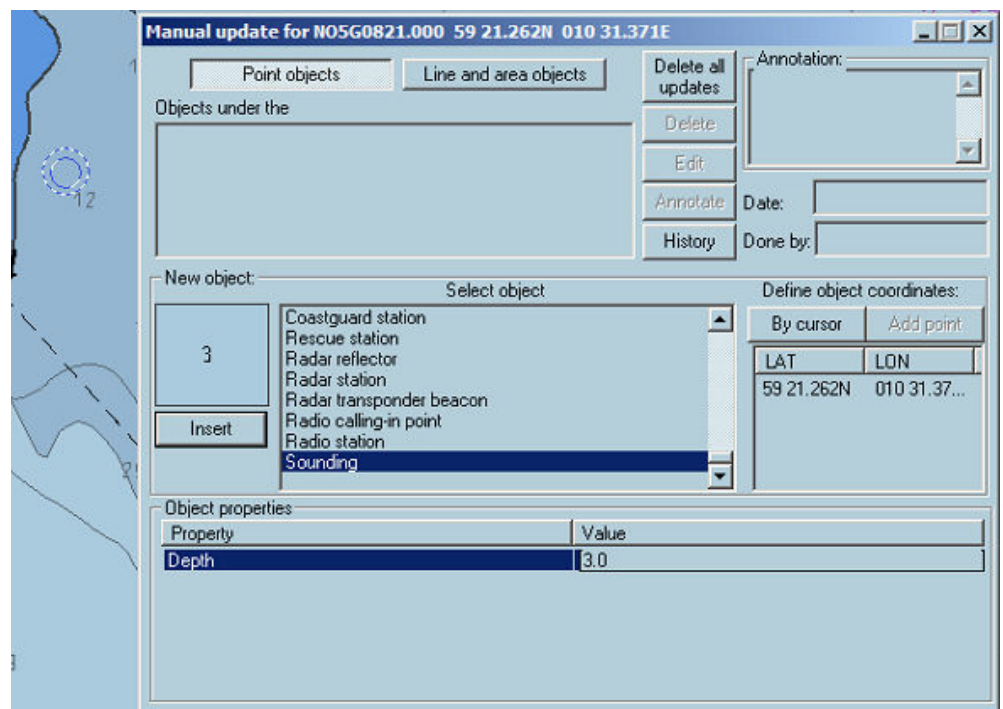



→ **Note:** The sounding object is visible only with proper chart settings.

Insert/Line area objects

1. Click right button on the chart at the appropriate position and activate the menu **Manual update**.
2. Select the object type: Line/area objects.
3. Select the type of line or area object you want to insert.
4. Insert the list of coordinates of the line or area points or make the area by cursor.

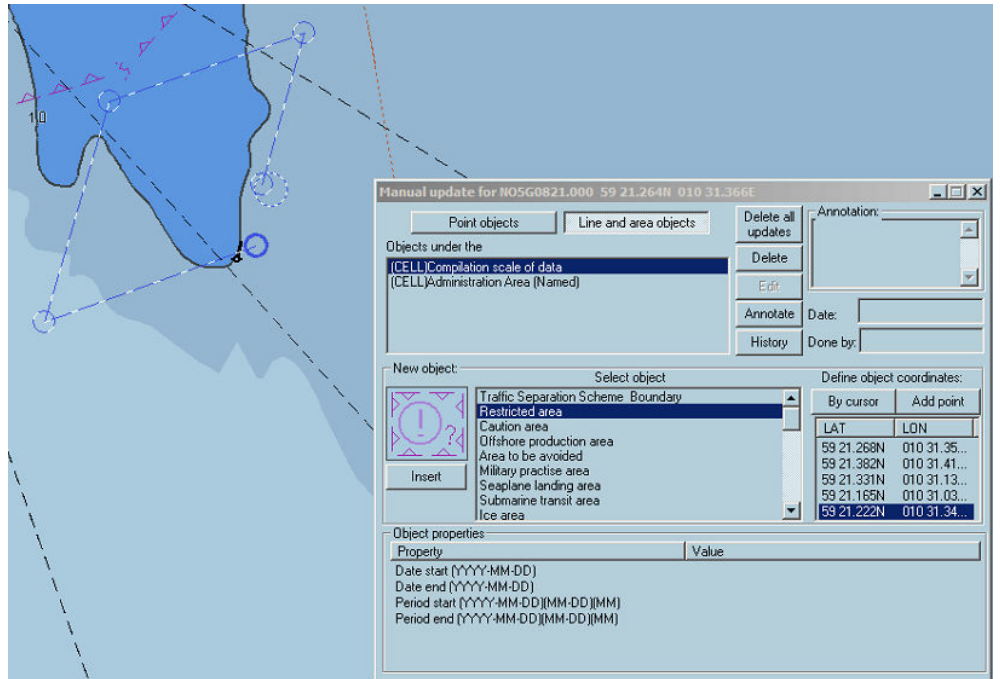

5. Set the date values if necessary.

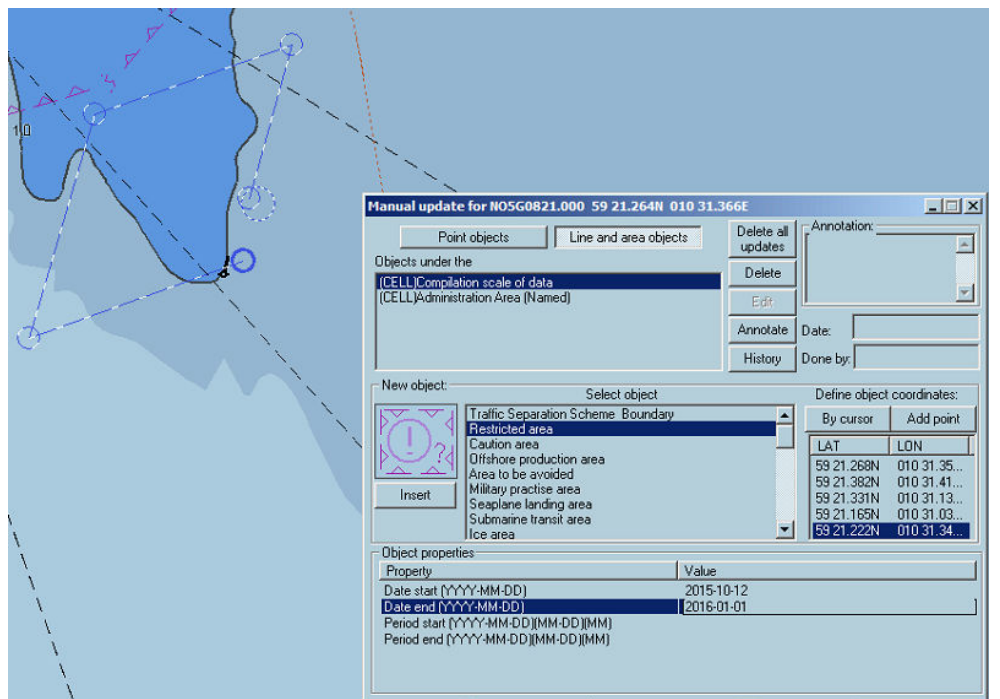

6. Press **Insert**.

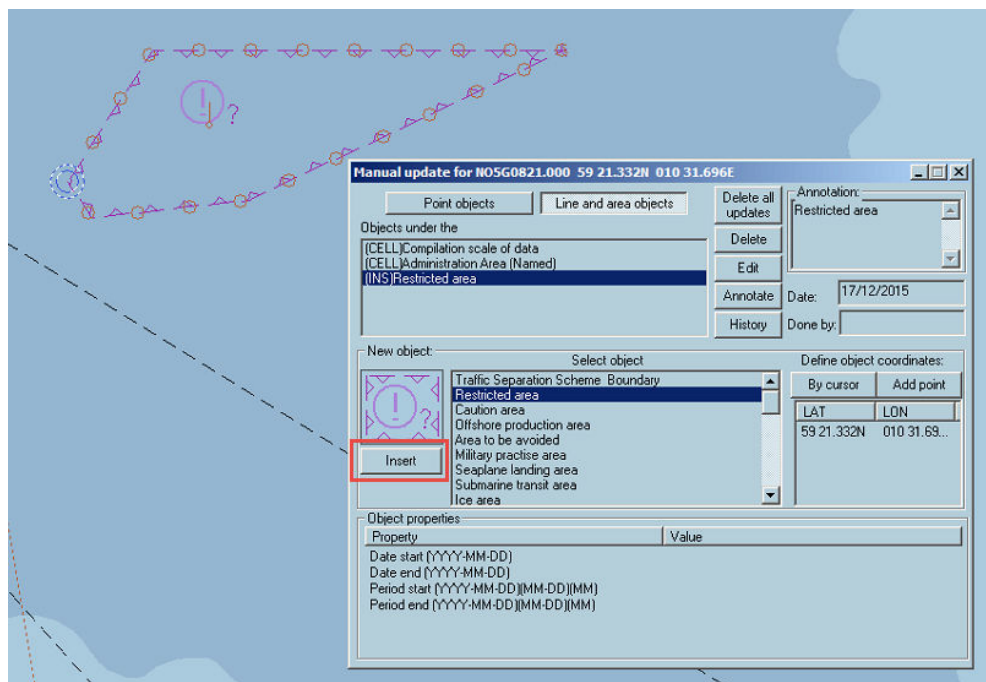

Set the future start date

It is possible to insert areas that will be activated in future. It means that the start date is later than the date when the object is created.

1. Create the area following the standard procedure.
2. The alert is displayed.

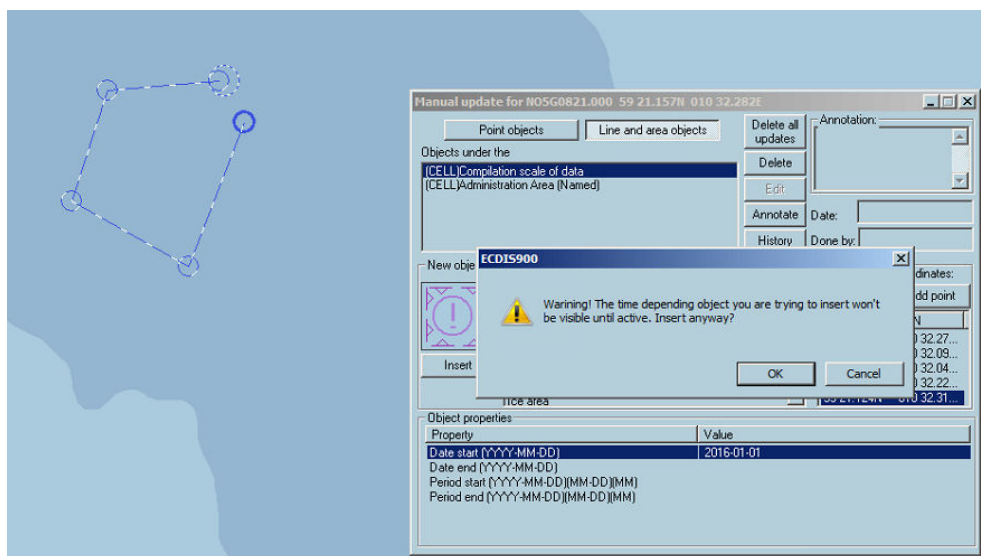

3. Click OK.

→ **Note:** The object will appear in time. Before the starting date it stays invisible, but it is in the cell properties.

Move object - Remove updates

Move point objects

1. Click right button on the object.
2. Activate the menu **Manual update**.
3. Select the object type: point object.
4. Select one component of the object.
5. - Double click on the point coordinates and the new ones in the Select point position dialog.

- Click the By cursor button and set the new position with the mouse.
- The blue circle indicates the new position.
 - Press **Move**.
 - Repeat the operation for all components

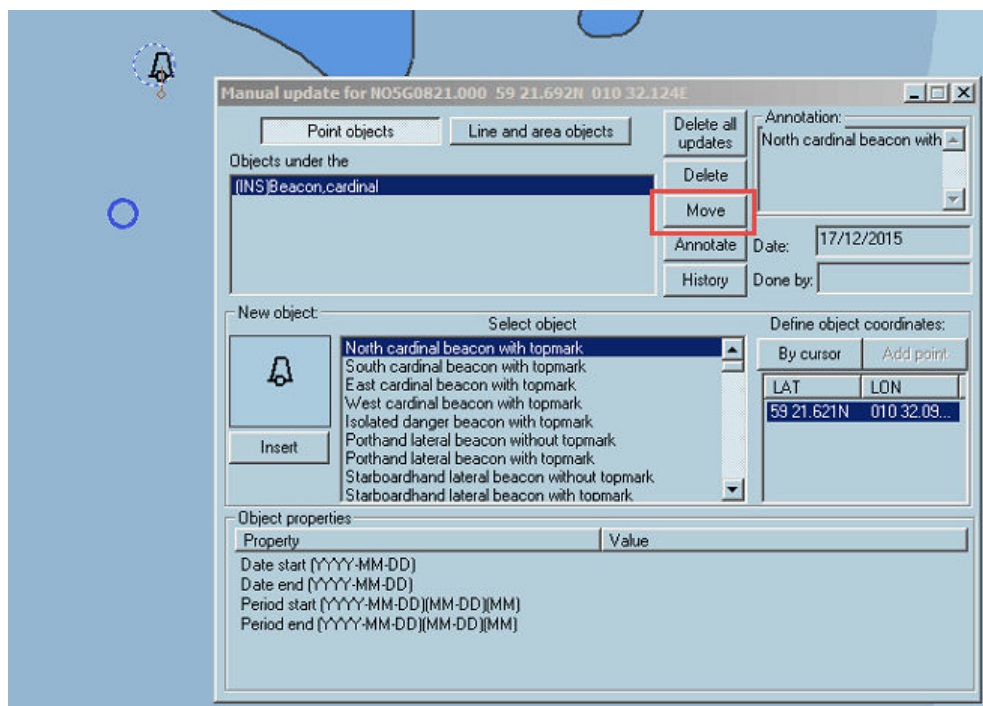

Edit area object

The Manual updates dialog allows area objects modification.

- Right click on the area and activate the Manual updates dialog.
- Select the inserted object from the list and press **Edit**.

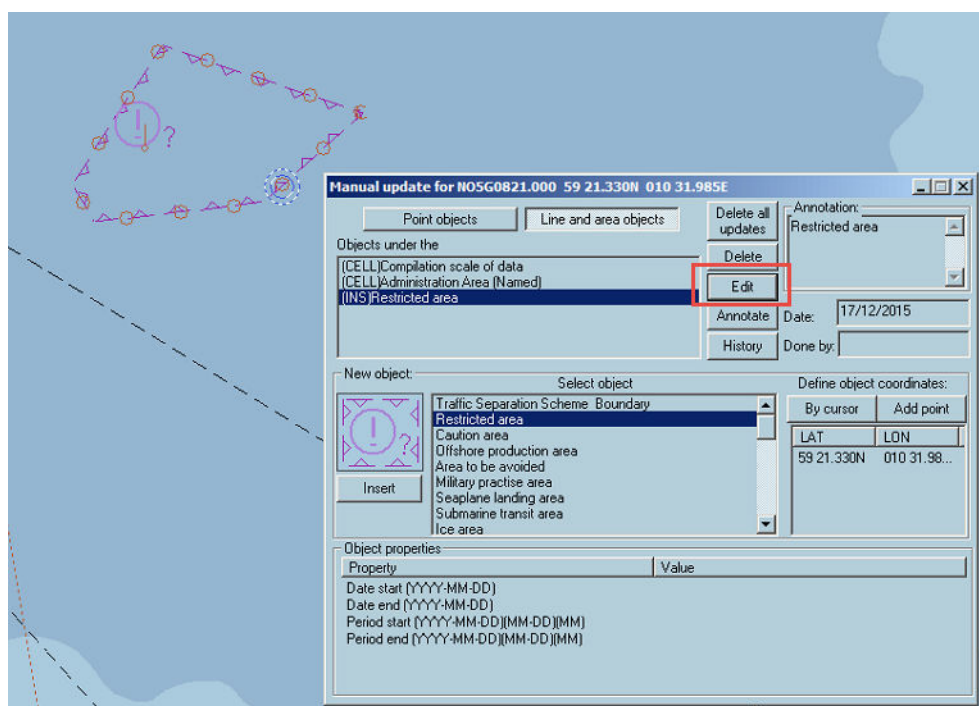

- Select a point to be moved.
- Move the selected point using mouse.
- Move the selected point using keyboard.

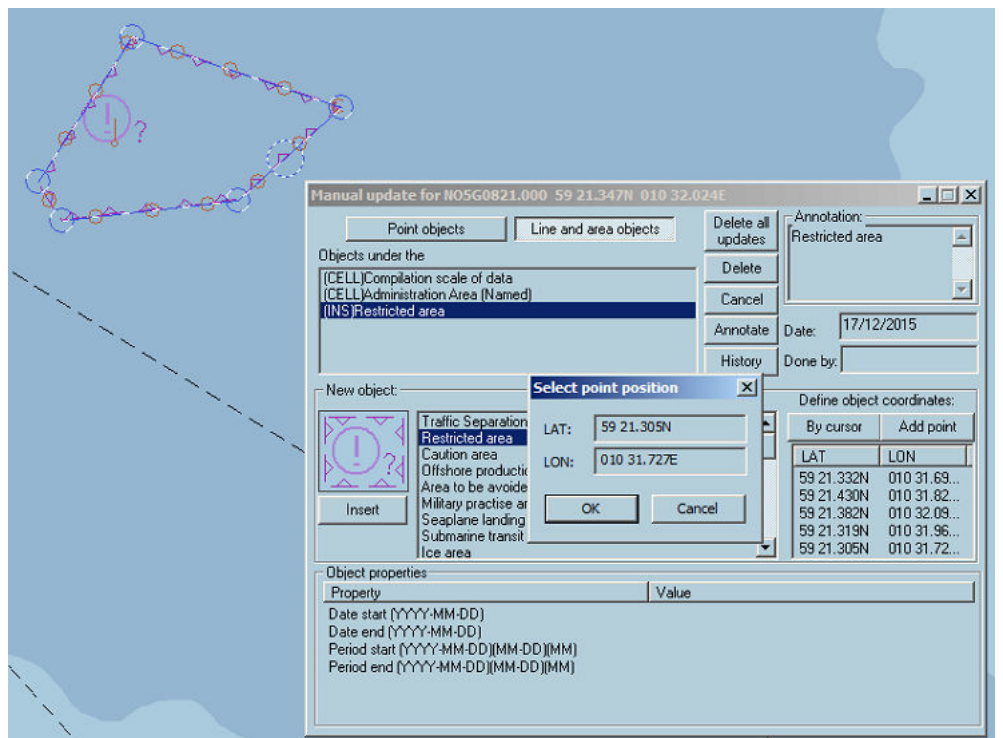
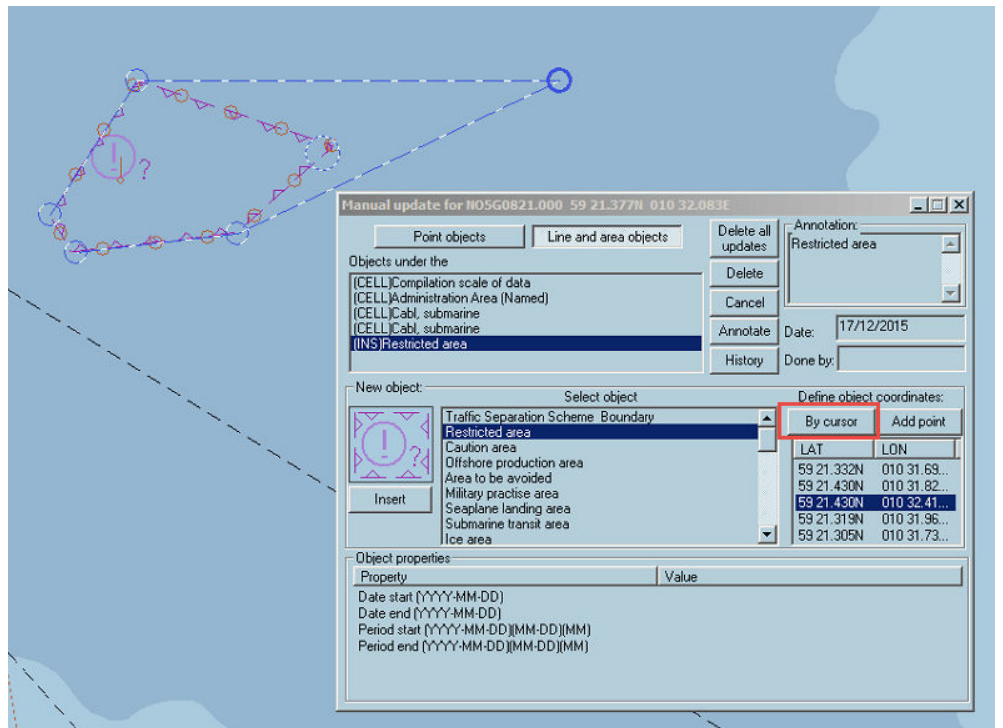

5. Press **Enter**.

Removing Manual Updates

Manual updates of all kind can be removed with the functions “Delete all update” available in the manual update window.

→ **Note:** The function is applicable only on the loaded cells.

Update history

Press the button History to get the list of all manual updates applied on the cells.

19

Predictor

Predictor and Docking function are activated with in ECDIS toolbar.

The Predictor functionality in ECDIS900 displays a future position and a historical position of the ship. These positions are calculated based on former ship data and applying some user defined settings. The Predictor is a navigation aid to be used for continuous dynamic ship's position prediction within 15 – 60 secs.

The predictor calculations are base on a vector prediction algorithm that uses the latest historical data: ship's position, speed over ground, course over ground and heading. Rate of turn and ROT acceleration are calculated from historical values and are used to predict ROT and heading.

The user has to enter proper ship's parameters and settings for a accurate calculation.

To run the function, an interface to GPS and Gyro must be available.

→ **Note:** The heading input value should at least contain one decimal.

To activate the function press the button Target prediction and toggle the check box **Use vector predictor** ON.

The active leg window available in the console area allows the user to control the position of the ship against the active route.



Principle

To be able to calculate the future position, ECDIS must be connected to GPS, gyro and log.

Depending from the chart scale the Predictor displays either prediction corridor (ship shape is displayed), either prediction line (ship icon is displayed).

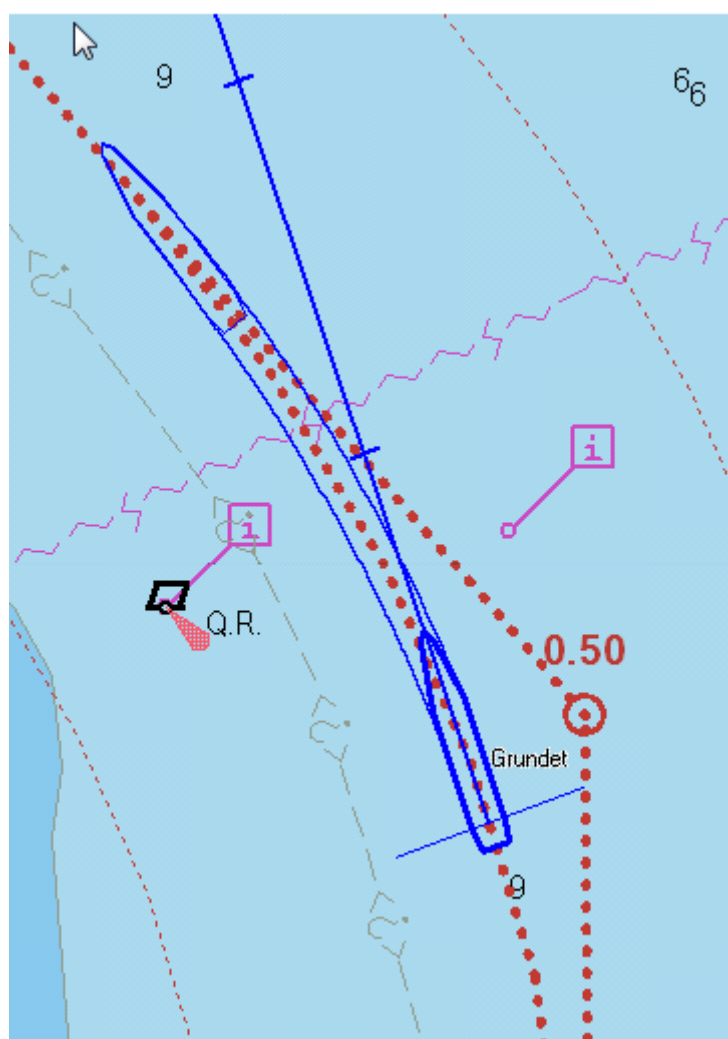

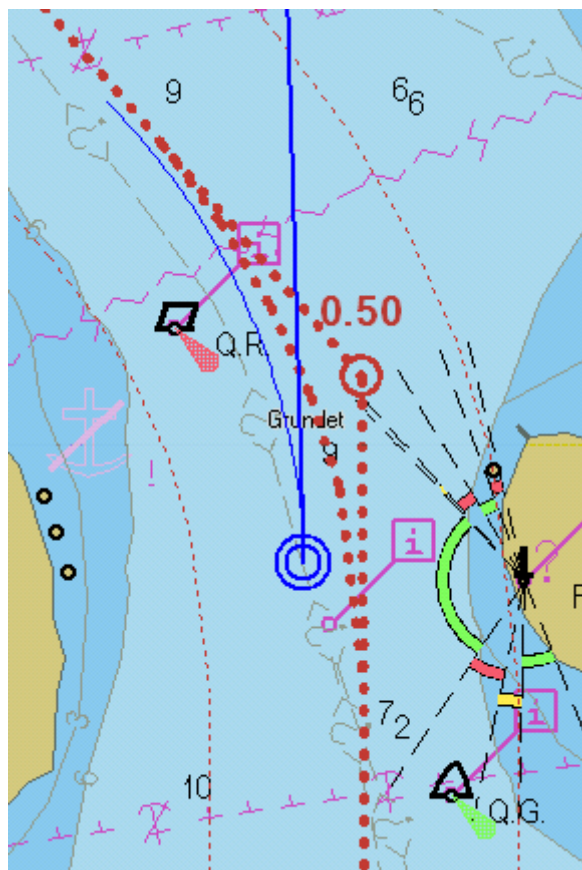

AIS target tracks calculation includes the rate of turn.

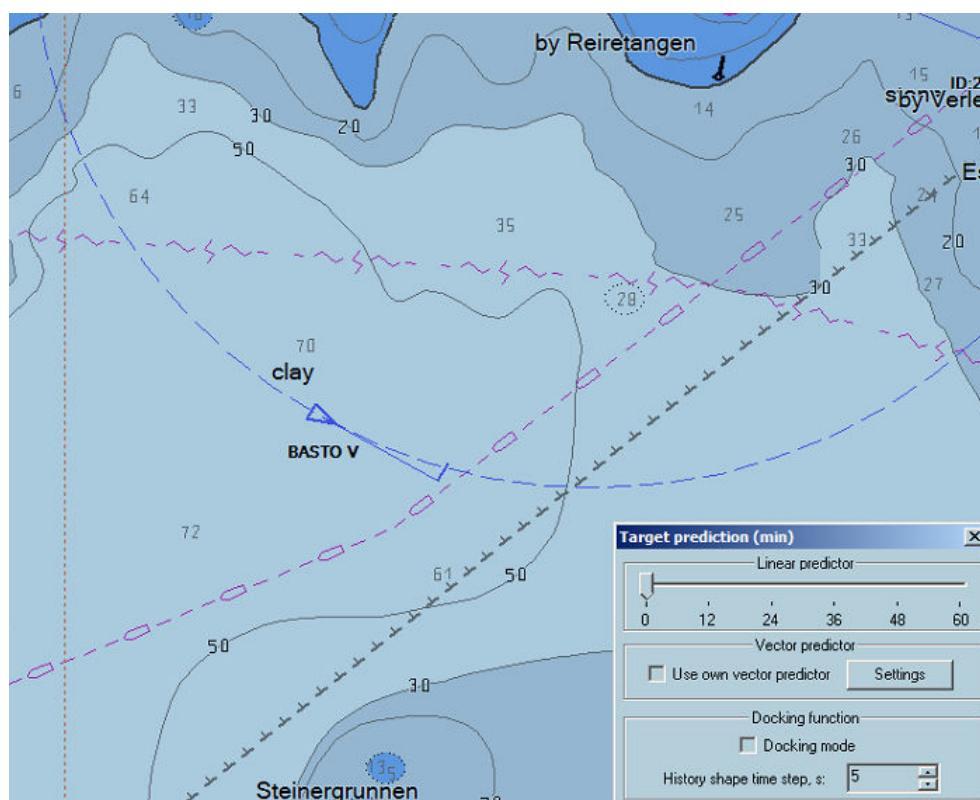

Docking

→ **Note:** The Docking mode available for speed lower than 6 kn.

To use the docking mode do the following:

1. Click the Target prediction button.



2. Tick on the docking mode.

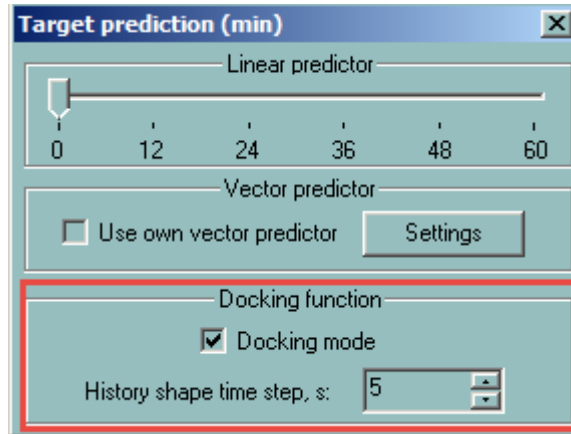

3. Right click on the Ship to bearing button.

4. Create the first anchoring point attached to the bow.

5. Create the second anchoring point attached to the stern taking in account that the circle radius is equal to the vessel length.

When operating the Docking mode the following data is displayed:

- Distance to anchoring point and speed for both bow and stern.
- 4 historical positions (step adjustable from 3 to 15 seconds).
- Predicted position
- For each anchoring point, course, distance and speed (cm/s) are displayed.
- 2 speed vectors are displayed from bow and stern.

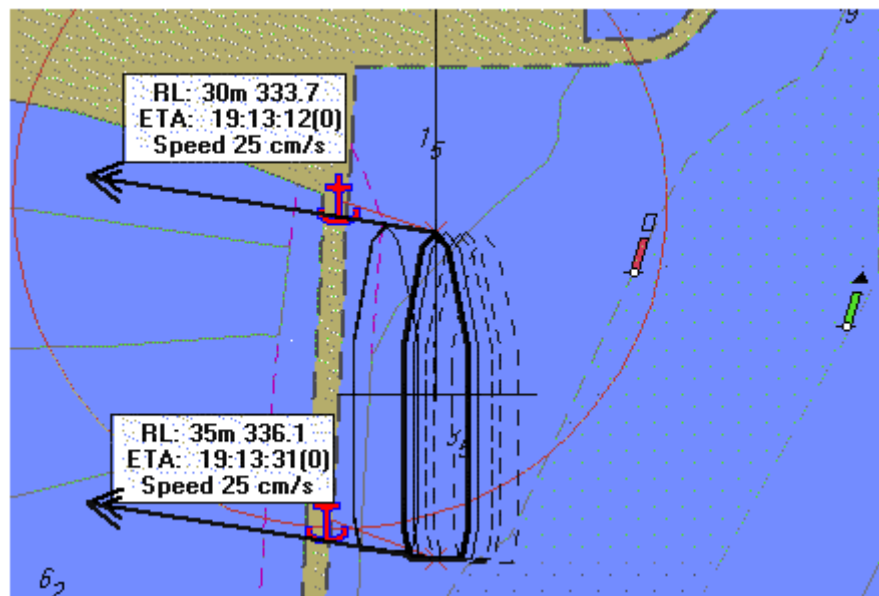

Settings

The following user defined settings are used during the calculation:

- Maximum ship speed: limit used in the calculation
- Maximum turn rate: limit used in turn rate calculation
- Prediction duration: ship symbol plot interval
- Time to reach ROT: sets limit to turn rate acceleration in the calculations. After rudder change, the ship starts turning, and ROT accelerates till constant ROT is reached. (Time to reach ROT = 0 means that using turn rate acceleration in the calculations is disabled)

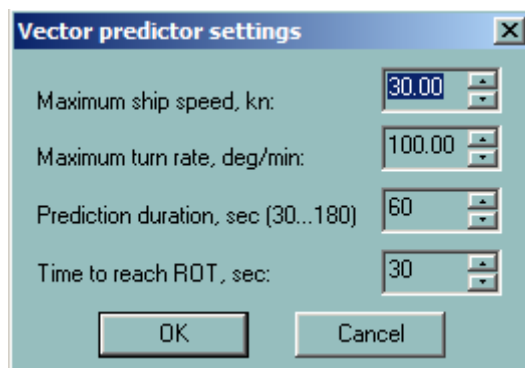

Historical values (heading, position and speed) are continuously recorded and processed:

- ROT value is calculated from historical values of the heading
- Acceleration of the ROT is calculated from the same set of values
- Acceleration of the speed is calculated from STW values.
- The PP (Pivot point) of the ship is calculated from GPS positions, speed and heading values
- The future positions are calculated by iteration (every second) as follow:
 - Last position
 - Last heading, ROT and speed
 - Time interval
- The new position of the PP is calculated from the above values, and the ship's orientation is displayed according to the new heading (Last heading received + ROT applied for the time interval within the limit of ROT and time to reach the ROT).

Active leg window

This option is designed to help mariners during navigation in narrow waters where precise following along the planned route is essential.

The ship's shape is displayed in the middle of the window together with the active leg and turning curves using a scale from 3500 – 10000 depending on the ship's dimensions.

The picture is leg bearing oriented. In the top left and right corners of the window, current leg bearing and next leg bearing are displayed.

In the bottom part of the window, XTD value is displayed. An indicator is displaying the direction where to go following the exact route.

In case of ship turning, this value is calculated for the end of turn showing how far away from the leg the ship will end its turn for the next leg.

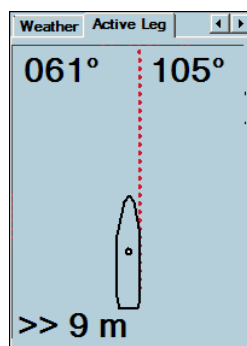

Moving along the leg

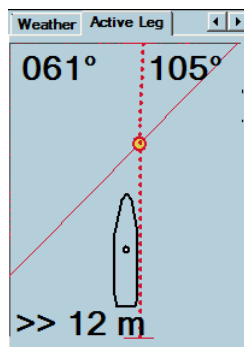

Approaching turning point.

The tool is designed to help the user to decide when to start turning to be able to follow exactly the active route.

It takes into account the distance the ship makes from the time navigator activates a turn till the ship actually starts to turn. Those values can be adjusted in the dialog **Distance to start turn**.

To access the settings push the button **Turning** in ship properties – page shape. If ship is for some reason away from the active route the decision to start turn should be done using the criteria of crossing the line passing through WOP and parallel to next route leg.

Please fill in the table of distances the ship makes from the time you activate a turn til time the ship actually starts to turn. This distance is used in Active Leg tool for precise navigation in narrow waters and depend from the ship speed.

Select loading profile:

	Ballast	Medium	Loaded	
Speed 5 kn	<input type="text" value="70.0"/>	<input type="text" value="70.0"/>	<input type="text" value="70.0"/>	m
Speed 10 kn	<input type="text" value="70.0"/>	<input type="text" value="70.0"/>	<input type="text" value="70.0"/>	m
Speed 15 kn	<input type="text" value="70.0"/>	<input type="text" value="70.0"/>	<input type="text" value="70.0"/>	m
Speed 20 kn	<input type="text" value="70.0"/>	<input type="text" value="70.0"/>	<input type="text" value="70.0"/>	m
Speed 30 kn	<input type="text" value="70.0"/>	<input type="text" value="70.0"/>	<input type="text" value="70.0"/>	m
Speed 40 kn	<input type="text" value="70.0"/>	<input type="text" value="70.0"/>	<input type="text" value="70.0"/>	m

Pivot point distance from the bow
It's used as origin for XTD calculation
 metr from the bow

20

SAR module overview

This module is designed to help navigator in creating SAR routes using selected options for SAR planning and operation.

Below are the different types of SAR routes:

- Expanding square
- Sector
- Parallel line

Access to the SAR module

Right click the **New Route** button from the toolbar panel.

A dialog similar below will be displayed.

Click **Create the route** button and modify the parameters.

SAR route

Type of search pattern

Expanding square

Sector

Parallel track. (DE area should be selected)

Start point

Latitude: 32 30.848S

Longitude: 060 55.153E

By cursor

Drift

Direction, deg: 0.0

Speed, kn: 0.0

Use calculated ship drift

Route

Route name: SAR_31/10/14_01_05_55

Radius of search: 5.0

Route spacing: 0.50

Clear the route Create the route Close

SAR symbols



According to IEC62288ed.2, SAR module displays AIS aids to navigation (AToN) symbols for physical and virtual objects.

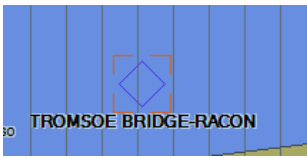
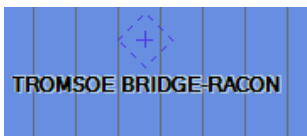

Basic shapes

	Basic shape, physical
	Basic shape, virtual

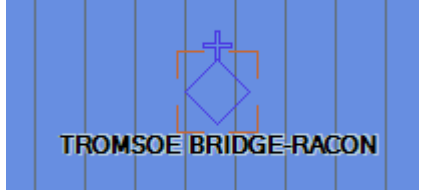

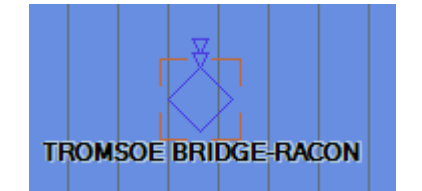
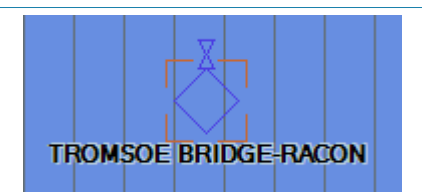
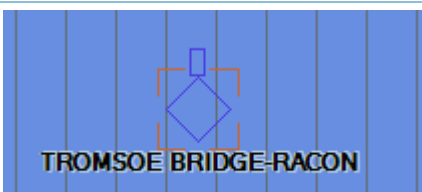
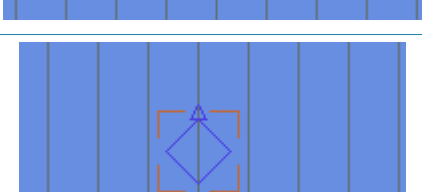

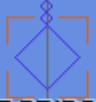
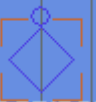
Purpose symbols

The symbols represented below are used for the physical AToNs only. The symbols used for the virtual AToNs are represented in the same way with the virtual basic shape shown above.

	<p>Racon</p>
	<p>Emergency wreck mark</p>
	<p>North cardinal mark</p>
	<p>East cardinal mark</p>
	<p>South cardinal mark</p>
	<p>West cardinal mark</p>
	<p>Port hand mark</p>
	<p>Starboard hand mark</p>

 <p>TROMSOE BRIDGE-RACON</p>	Isolated danger
 <p>TROMSOE BRIDGE-RACON</p>	Safe water
 <p>TROMSOE BRIDGE-RACON</p>	Special mark

Failure symbols

<p>Off Posn</p>  <p>TROMSOE BRIDGE-RACON</p>	Off position
<p>Unlit</p>  <p>TROMSOE BRIDGE-RACON</p>	Lights failure
<p>Racon err</p>  <p>TROMSOE BRIDGE-RACON</p>	Racon failure
<p>Missing</p>  <p>TROMSOE BRIDGE-RACON</p>	Missing

SAR aircraft

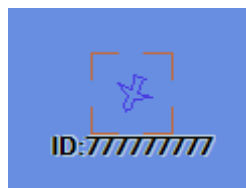

SAR vessel

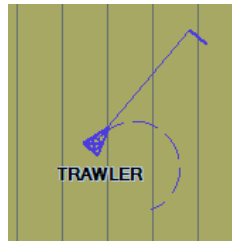

Expanding square option

To expand the square, follow the steps below.

1. Click the **By Cursor** button to manually select the start point of the route. The position of the ship can also be plotted as a route directly on the chart.
2. Select the **Direction of Search** field and in the **Drift** tab, choose **Direction**.
3. In **Drift** tab, select the **speed to proceed the route**.
4. Select the **search area** field and choose **Radius of search**.
5. Select the **space between leg** and choose **Route spacing**.

Parallel line option

Plot an area with Object Editor tools.

1. Select the area.
2. Right click on the button Create route.
3. The start point of the route is either the closest point located on the edge of the area from the ship either selected manually by pressing the button By cursor and plotting the starting point directly on one edge of the area.
4. Select the speed to proceed the route in the Drift panel.
5. Select the space between leg with the parameter Route spacing.

21

Seismic module

This module acquires streamers and buoys and process data from the system called TRINAV. The positions of streamers and the different buoys are displayed in the electronic charts. The seismic module calculates and triggers alarms when targets entered the security zone defined around the streamers or when the seismic vessel is sailing in dangerous areas. The Radar kit is necessary to overlay the Radar video on top of the chart that is installed on a remote NetPC.

Seismic data

Data acquisition

For Western Geco vessels, most of the data is acquired from a central unit called TRINAV. The data includes:

- Buoys positions
- Streamers positions
- Own vessel position, course and speed
- Survey area
- Survey lines

Buoys

The buoys are equipped with GPS where the course position and speed is broadcast every two seconds.

There are three types of buoys:

- Buoys located at the end of the streamers.
- Buoys located at the start of the streamers. These buoys are very rare as of the moment.
- Buoys located at the shorting place close to the ship.

The most recommended buoys are the two buoys located at the end of the two outer streamers. The buoys are named from starboard to port 1,2 ..X

→ **Note:** F001 is a starboard buoy
F0xx is the port buoy

Display

ECDIS900 are handling buoys as targets. This is displayed with special icon and a vector. The normal target in ECDIS calculates the course and speed for each buoy. This does not trigger any CPA alarms.

The **Icon:** for each buoy is indicated with a name and with a multi color big triangle.

The **Track** trail for each buoy is displayed upon request. Track line is shown in the chart.

The **Streamers** is sent and displayed in the chart area every 20 seconds. There are no limitations for the number of streamers. The maximum captors for one streamer is 9.

The shape of the cable can be defined up to 11 positions.

→ **Note:** To avoid the positions to jump between two receptions, ECDIS900 calculates every second intermediate positions of the buoy. This is derived from the previous position of the buoy, speed, course and the time from the last reception.

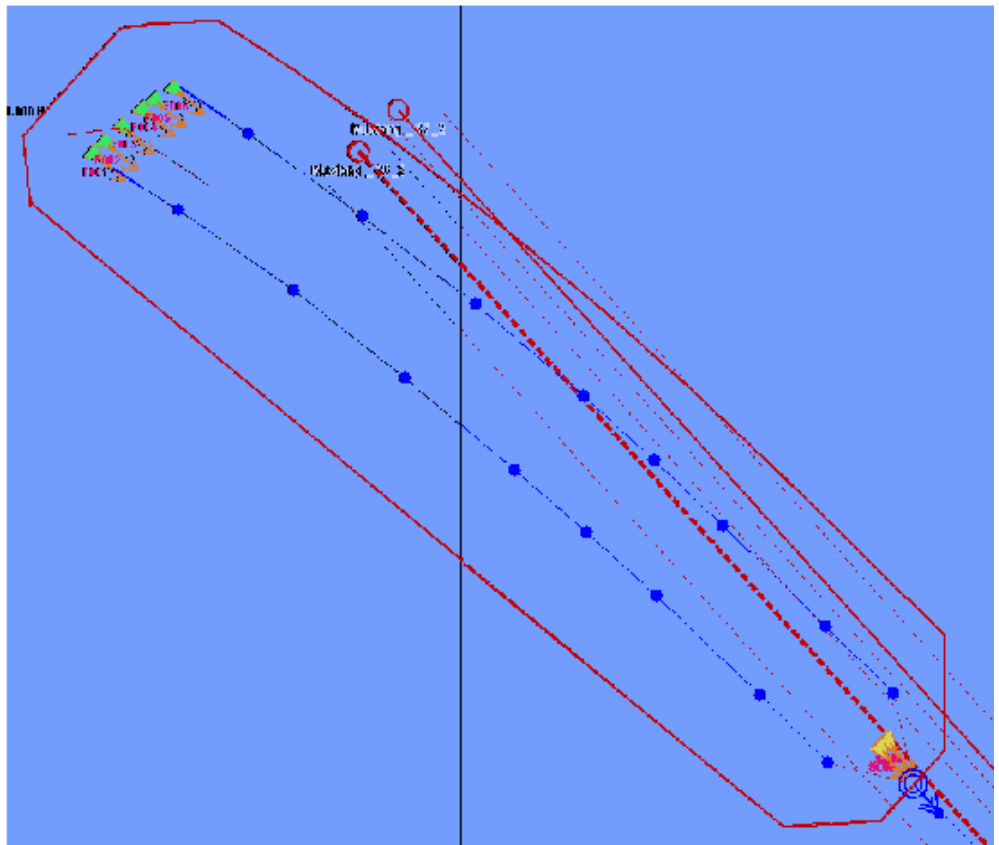

The image shows the ship's icon and buoys located at the shooting place. It also shows two streamers and 6 tail buoys.

The red area displayed around the streamers is the safety zone. This area is defined and configured by the user.

The vectors displayed in front of the ship and the buoys with ending points shows the future positions (according to the user selection: from 1 minutes to 60 minutes) of the objects.

Display customization

You can configure the display in the **Ship's properties** dialog. Select **Streamers** tab and customize the display of the streamers by selecting an option from the list.

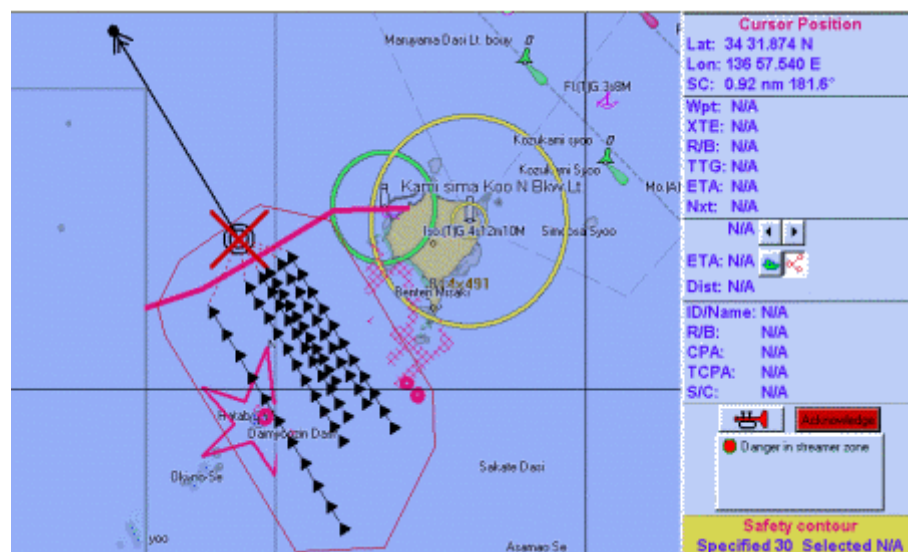

→ **Note:** You can hide one or several streamers that are not important.

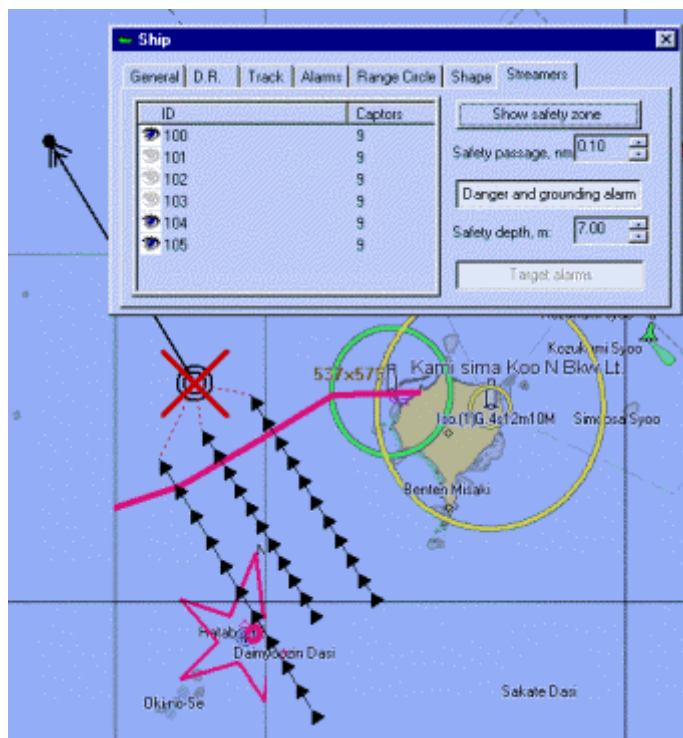

Survey area and survey lines

ECDIS900 can receive and display information about the survey area and the survey lines.

The survey area is stored as an OE object in ECDIS900 and can be displayed upon request.

The survey lines are stored as routes in ECDIS900 route database. This should have the same name as in the internal system in the TRINAV.

One survey line is a route defined by two waypoints.

Planning mode

The survey area is displayed with a black colored lines and icons.

Several survey lines that are downloaded from the TRINAV system are displayed as planned route.

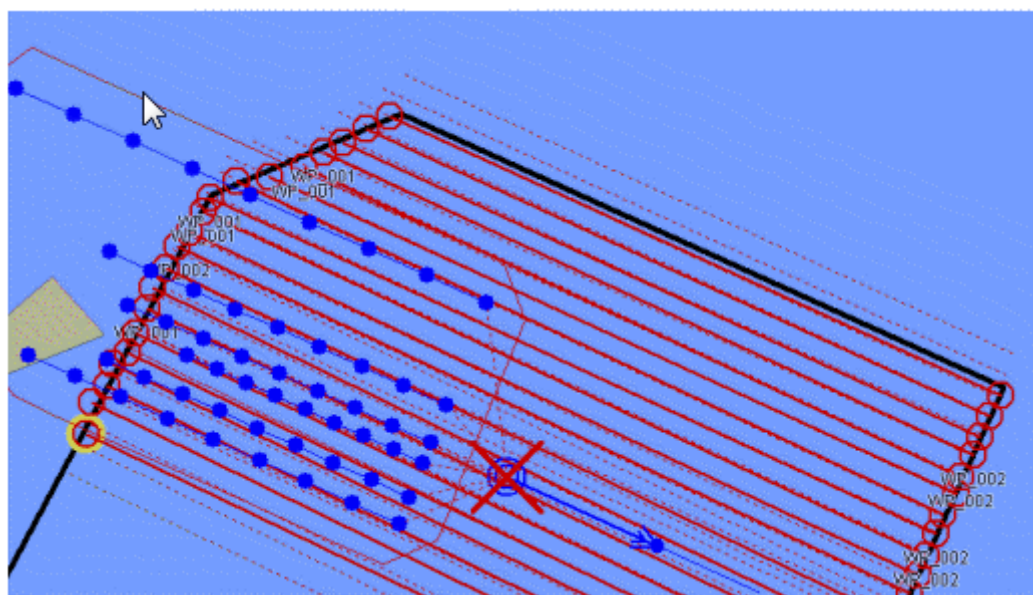

→ **Note:** A survey area can include up to 1000 different survey lines.

Monitoring mode

During the survey operation, one survey line is selected as active in the TRINAV system for the seismic calculation department.

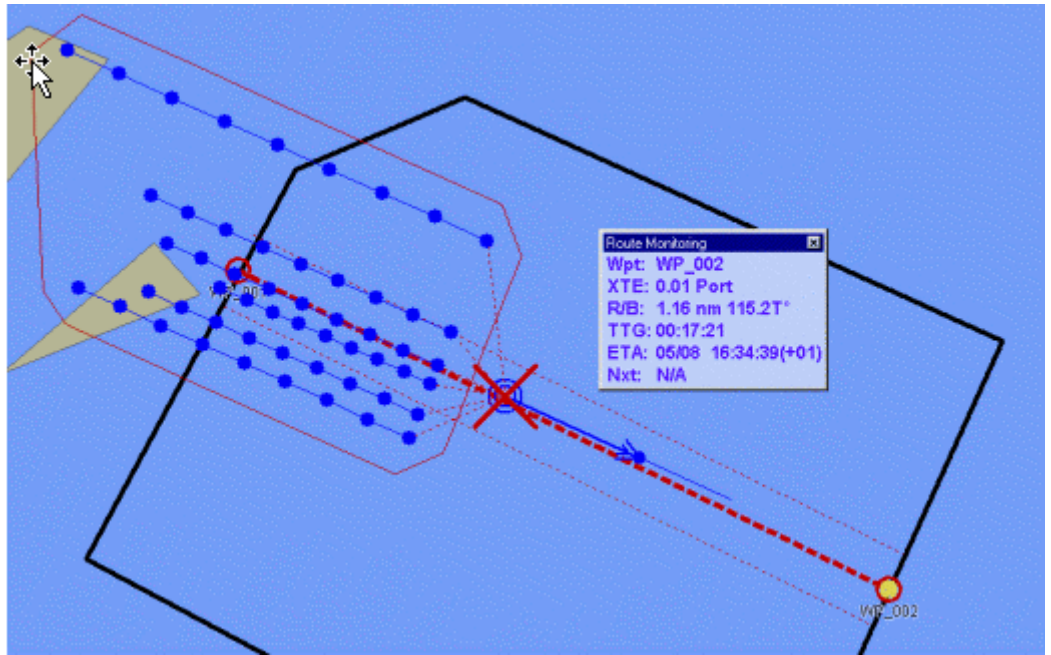

It is important to display the same active route in ECDIS900. The active survey line has to be manually selected by the navigator in ECDIS900.

To configure, click the **Load\Unload objects** dialog and select the active route for ECDIS. The system calculates and displays the XTE (Cross Track Error) and the ETA to the end of the survey line.

Safety zone

The safety zone is an area defined around the streamers in which special alarm functions are applicable.

ECDIS900 calculates dynamic safety area from the position of the external cables and the safety distance entered by the user.

To configure, enter the safety distance numbers in the **Safety passage** field.

Display

ECDIS900 displays a request of safety zone in the following dialog:

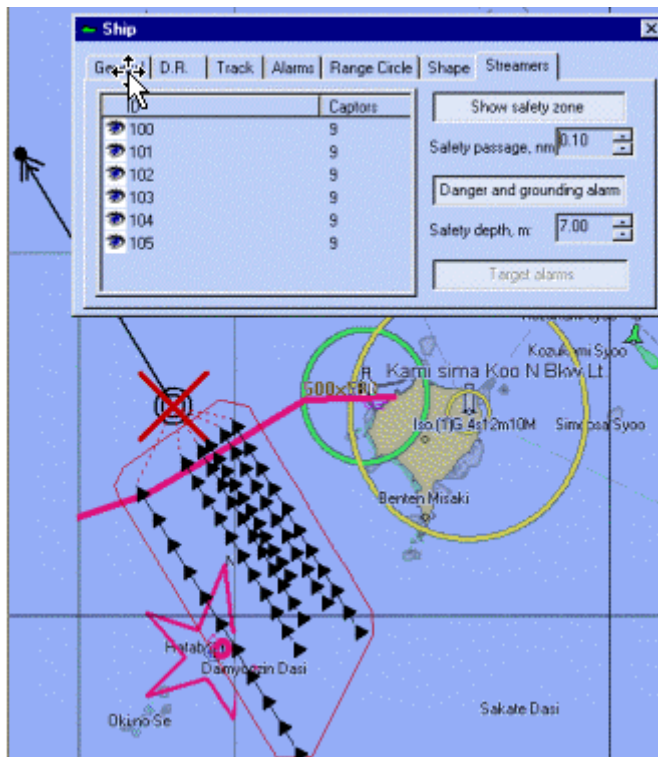

Grounding and danger alerts

Standard ECDIS system includes alerts on the safety distance and the safety depth of the ship.

It also checks grounding and danger alerts inside the safety area and triggers alarms when necessary.

→ **Note:** Alerts are displayed on the chart with a wide line and a red star around the isolated dangers.

Seismic module configuration

Architecture

The ECDIS system installed on the seismic ship is based on two workstations installed in the bridge. These are ECDIS900 Monitoring station and NetPC.

The ECDIS900 monitoring station is used to display the electronic chart or the Radar video and the NetPC is used as Radar Video server.

The two workstations acquire navigation data from different sensors connected by serial lines. NetPC also acquires the raw Radar video from the two Radar transceivers with MK PC Radar Kit.

These two workstations also share and exchange data using TCP IP messages on LAN.

Other workstations connected to the ship's LAN can run ECDIS900 or ARPA2000 applications. These workstations share and display the same data than the workstations installed in the bridge.

Navigation data

Navigation data are acquired by serial lines connected either to the Monitoring station or to the NetPC.

Each work station should have a Sensor monitor installed in it. The Sensor Monitor is in charge of analyzing and transmitting the analyzed data.

All analyzed data like position, time, course and speed, depth, targets and other relevant data are sent on the LAN. It should be sent using a broadcasting mode so that all computers of the network running ECDIS900 can use them.

Set up

The set up of the serial input to the Monitoring station is done during the installation process of the ECDIS900. It can be modified any time using the Sensor Monitor application.

The set up of serial input to the NetPC is done when the ECDIS900 is already set up. To modify the NetPC, use WINVNC on the monitoring station.

Radar video data

Radar video is acquired on the NetPC using the PC Radar Kit. It can also acquire information from the Extractor\Tracker (EXT) application. The video is digitized on the NetPC and sent on the LAN.

In normal mode, the video is sent on the ship's LAN in broadcasting mode. All computer connected into the LAN can use and display the Radar video picture using ARPA2000 application.

In ECDIS900 computer, an overlay is use to broadcast the Radar video on top of the electronic chart.

→ **Note:** The network traffic increases significantly as the radar video is broadcasted throughout the LAN connection.

The following may reduce the network traffic:

- Configure Extractor\Tracker to send the Radar video to a particular IP address (The IP address of the Monitoring station). This will enable users to use and access the Radar video on a specific station only.
- Use a sub network as ECDIS sub network. This requires the network administrator of the ship to set up the network with appropriate configuration and routers.

- Install a separate network for you ECDIS900 computer and ARPA2000. This requires to install Network cables (and eventually additional Network cards) to link the Monitoring station and the NetPC.

22

Annexes

Terms and abbreviations

AIS	Automatic Identification System
BAMS	Bridge alarm management system
BNWAS	Bridge navigational watch alarm system
ECDIS	Electronic Chart Display and Information System
IHO	International Hydrographic Organization
INS	Integrated Navigation System
NAVTEX	Navigational Telex
NMEA 0183	Text communication protocol
NMEA 2000	Communication standard

ARPA	Automatic Radar Plotting Aid
BRG/RNG	Bearing/Range
COG	Course over ground
DGPS	Differential Global Positioning System
DIST	Distance
D.R.	Dead reckoning
ETA	Estimated time of arrival
FWD	Forward
GC	Great circle
GND	Ground
GPS	Global Positioning System
Gyro	Gyrocompass
HCS	Heading control system
HDG	Heading
HDT	Heading -True
HSC	High speed craft
kn	Knot
LAT	Latitude
LON	Longitude
LOP	Line of position
MAN	Manual
MOB	Man overboard
NM	Nautical mile
OOW	Officer on watch
PI	Parallel index line
POSN	Past positions
PWR	Power
RAD	Radius
RNG	Range
ROT	Rate of turn
SAR	Search and Rescue

SCAMIN	The minimum scale at which the object may be used
SOG	Speed over ground
SPD	Speed
SPD/CRS	Speed/Course
STBD	Starboard side
STW	Speed through the water
TCS	Track control system
TTG	Time to go
UTM	Universal transverse Mercator
UTC	Universal time, coordinated
VDR	Voyage data recorder
VRM	Variable range Mercator
WGS	World geodesic system
Wind T/R	Wind True or Relative
WOP	Wheel over point
WPT	Waypoint

Chart management and charts

AIO	Admiralty Information Overlay
ARCS	Admiralty Raster Chart Service
AVCS	Admiralty Vector Chart Service
ENC	Electronic Navigational Charts
GB	AVCS chart collection
PM	Primar chart collection
RCDS	Raster chart display system
S-57 (IHO S-57)	Electronic navigational chart standard format
SENC	ECDIS chart format
SA certificate	Scheme Administrator certificate

Profile configuration parameters

The following parameters are saved for a user profile:

Chart related sector

- Accuracy
- Date dependent objects
- Highlight date dependent
- Full light lines
- Highlight info
- Highlight document
- Unknown
- Scale min
- Shallow pattern
- Shallow water dangers
- Contour labels, if provided
- Four shades, if provided
- National language, if provided
- Paper chart/Simplified symbols
- Plain/symbolized boundaries
- Text group layer

Graphical indication, if selection provided

- of crossing safety contour during route planning
- of prohibited areas, areas with special conditions and navigational hazards during route planning
- of crossing safety contour during route monitoring
- of prohibited areas and areas with special conditions during route monitoring
- of navigational hazards during route monitoring

- Selected sea area
- Range
- Orientation
- True motion reset
- Geodetic datum, if selectable
- Manual updates
- Mariner's notes
- Selected route
- Past track
- Past track length, if selectable
- Past track time-labels
- Look-ahead time
- Any edit window
- Position data source
- Safety contour
- Safety depth
- Cross track limit
- Distance to prohibited areas, areas with special conditions and navigational hazards
- Object highlight, selected object, track display from log
- Cursor pick
- Any additional window (dual view, 3D, tides)
- Any additional information layer, proprietary layer (weather, tides, AML)
- Chart update, chart information exchange
- Color differentiation test diagrams
- Update review
- Chart 1
- Units
- Crossing a navigational hazard in route monitoring mode
- Vector time (length)
- Vector mode
- Vector stabilization
- Symbol for target association, if provided

- Collision warnings, if provided
- Radar and AIS target association, if provided
- AIS target filtering, if provided
- AIS true target outline
- Display of Radar image overlay, if provided
- Display of Radar tracked targets, if provided
- Display of AIS reported targets, if provided
- Target past positions, if provided
- Target trails, if provided
- Lost target warning, if provided
- Lost target warning range, if provided
- AIS interrogation, if provided
- Own ship true outline
- LOP source indication
- User selected time for warning escalation
- Suppression of indication of user selected MSI messages based on first character of NAVTEX code field, if provided
- Suppression of indication of user selected messages based on time and distance from own ship, monitored route or planned route
- Brightness and contrast controls, if software controlled

23

Troubleshooting

Encryption scheme errors in ENC

The following is a list of errors that can occur during ENC chart management.

Error codes	ID	Error messages	User actions
SSE01, SSE02	-1, -2		Not used
SSE03	-3	Certificate is invalid	Corrupted file with digital signature
SSE04	-4	Format of Certificate is incorrect	Contact your ENC chart agent or distributor
SSE05	-5	SA Digital Certificate file is not available	Get (SA) certificate by Internet
SSE06	-6	SA Digital Certificate is invalid	Get (SA) certificate by Internet
SSE07	-7	Certificate file is not available	User try to install the chart from not licensed media
SSE08	-8	Format of private key is invalid	Contact your ENC chart agent or distributor
SSE09	-9	Signature is invalid	Contact your ENC chart agent or distributor
SSE10	-10	Files are different (check after decryption).	Contact your ENC chart agent or distributor
SSE11	-11	Cell Permit file not found	Get permits from your ENC chart agent or distributor
SSE12	-12	Cell Permit format is incorrect	Get new permits from your ENC chart agent or distributor
SSE13	-13	Cell Permit is invalid (checksum is incorrect).	Corrupted file with permits (enc.pmt or permits.txt)
SSE14	-14	Incorrect system date	Not used
SSE15	-15	Subscription license has expired	Renew license
SSE16	-16	ENC CRC value is incorrect	Corrupted ENC file. Contact your ENC chart agent or distributor
MERR_CHART_TOO_OLD_FOR_PERMIT	-29	Chart is too old for used permit	Update the chart
MERR_CELL_FILE_NOT_AVAILABLE	-17	Cell file is not available	Contact your ENC chart agent or distributor
MERR_CANNOT_CREATE_ZIPFILE	-18	Decryption process error	Contact NAVICO
MERR_PKZIP_NOT_FOUND	-19	At least one service of encryption system is not found.	Run setup program
MERR_CANNOT_RUN_PKZIP	-20	Decryption process error	Contact NAVICO
MERR_CANNOT_UNZIP_CELL	-21	Decryption process error	Contact NAVICO

Error codes	ID	Error messages	User actions
MERR_AUTENT_CELL_ERR	-22	Cell Authentication error	System error. Contact NAVICO
MERR_CANNOT_READ_CATALOG	-27	Cannot read the Catalog file	User try to install the chart from not licensed media. Use the licensed media.
MERR_ENWAR_NOTFOUND	-28	Environment variable not found.	Run setup program.
WARNING_SUBS_WILL_EXPIRE	2	Subscription service will expire in less than 30 days	Contact your ENC chart agent or distributor for a subscription renewal.

Common errors in ARCS chart management

The following is a list of errors that can occur during ARCS chart management.

ECDIS ERROR MESSAGE	Description	What to do	BA error code
Invalid (altered) gb.lcn-file	License is invalid and a checksum error is detected while reading the GB.LCN file.	Re-install permits. If this does not help contact MARIS to correct the error.	ARCS01
→ Note: Do not change the expiration date of the license using text editor.			
Chart permit corrupted. Please reload from the original media.	The installed chart permit file is corrupted.	Re-install the chart permits from the latest BA floppy disk using the chart handling function.	ARCS02
The update relates to a newer version of the chart.	The update relates to newer version of the chart.	This means that a newer edition of the chart has been issued and you are still using the old edition. There are two cases: <ul style="list-style-type: none"> • A new edition of the chart is located on the update CD. • The Area CD containing the chart has been re-issued. • Chart should be installed and updated from the appropriate media. 	ARCS03
The chart is newer than the update.	The chart is a newer version than the update.	The chart data already includes a New Edition of this chart and the update CD selected is older. It is necessary to use the latest update CD.	ARCS04
The nav. License has expired no update is made.	The license has expired	License expired – updating is not permitted. Please contact NAVICO to renew license.	ARCS05

ECDIS ERROR MESSAGE	Description	What to do	BA error code
Warning! License expires in less than one month.	The navigation permit for the chart will expire in less than one month.	Please contact NAVICO for a license renewal.	ARCS08
License expired in the last month.	The navigation permit for the chart expired within the last month.	Please contact NAVICO for a license renewal.	ARCS09
Nav. License expired more than 1 month ago.	The navigation permit for the chart has expired more than one month ago.	Contact NAVICO for a license renewal.	ARCS10
Chart is too old for this nav. license.	The chart permit relates to a newer chart edition.	The loaded version of this chart is too old to be used with the permit. Please load a more recent version of the chart from the area CD or the Update.	ARCS11
No error message	The specified permit types do not match (when merging permits).	Proper permit (Navigator or Skipper) option should be selected while merging permits.	ARCS_DIFFERENT_PERMITTYPE
No License File or Chart Permit File found!	There are no files called gb.lcn or gb.ncp in the folder selected by the user.	Select correct folder in which the files gb.lcn and gb.ncp are located	ARCS_NO_PERMITS
The License File is invalid.	The format of the chart permit file does not match gb.lcn-file structure.	Install permits from the original BA CD containing the permits.	ARCS_INVALID_LCN
No error message is displayed but it is impossible to install or update permits or charts.	The catalogue files or chart files are corrupted.	Delete manually the following files: <ul style="list-style-type: none"> • All files located in the folder C:// Ecdis/ Data/ Arcs_data/ Chartcat • All folders located in the folder C:// Ecdis/ Data/ Arcs_data/ Rachts • C:// Program files / Ecdis_2/ Data/ Arcs_data/ Chartcat/ Config.arcschart.cfg 	

Guidelines for troubleshooting for ARCS chart management

Problem	Try this
The chart permit for a chart has been successfully installed but the chart from the CD cannot be installed (invalid permit).	Most likely the chart has been re-issued and the new version of the chart is stored on the update CD.

24

Maintenance

Computer maintenance should be performed at certain time intervals. Do not ignore any scheduled maintenance as this will affect the computer speed and could ultimately lead to a computer system failure.

Weekly

Check chart updates

C-MAP subscribers will automatically receive updates from NAVICO but it is still recommended to check for updates weekly.

Clean keyboard and mouse

Wipe keyboard and mouse with disinfectant wipes. Make sure that the wipes are not overly damp and that you squeeze out any excess liquid before wiping your keyboard or mouse.

→ **Note:** When using wet cloth, ensure to turn your computer off and unplug the power cord. Be careful not to allow any excess moisture to enter any openings and never spray anything directly onto your keyboard or mouse.

Monthly

Secure Backup data

Data loss can happen in many ways so keep a backup copy of your routes, charts and layers regularly. Always test your copied data, a backup is useless if it cannot be restored correctly.

Clean Computer fans

Depending on the location of your computer, you should vacuum the area around your desk and inspect the internal and external fans and ventilations to make sure they are free of hair, dust, and other debris that can cause heat-buildup in your PC.

→ **Note:** It is recommended to upgrade ECDIS software and change hardware components on a yearly basis. To order a Technician visit, please contact NAVICO at marissupport@navico.com.



SIMRAD