

BridgeMaster 
Radar

User Guide

Part Number 65800010A

NORTHROP GRUMMAN

Sperry Marine

© Northrop Grumman Sperry Marine B.V.

BridgeMaster



Radar

User Guide

Part Number 65800010A-6

Publication Revision A

Software Version 4.xx, 5.xx or SC1.xx

Before using the Radar equipment, please read this manual.

© 2003 Northrop Grumman Sperry Marine B.V.

This publication and the information contained herein is and remains the intellectual property of Northrop Grumman Sperry Marine B.V. Northrop Grumman Sperry Marine B.V. provide a limited licence for the user to reproduce this material for their own internal purpose and use, but not for distribution to third parties. Reproduction of this material for resale or commercial gain is expressly prohibited.

Northrop Grumman Sperry Marine B.V. are not responsible for any loss or damage of any nature or kind whatsoever that may arise from either the use of this publication or its reproduction.

NORTHROP GRUMMAN

Sperry Marine

© Northrop Grumman Sperry Marine B.V.

Intentionally Blank

WARNINGS AND CAUTIONS

WARNING: Lethal Voltage Hazard

When access covers are removed, lethal voltages may be exposed. Some capacitors used in the equipment take several minutes to discharge their stored voltages after switch OFF, this is a lethal voltage hazard. Always set the supply switch-fuse to OFF and remove the fuses, before removing the access covers of the equipment.

WARNING: Health Hazard

When cleaning the inside of the equipment, take care not to inhale dust. The dust is a temporary health hazard, depending on individual allergies.

WARNING: Radiation Hazard

Keep outside the hazard zone around an antenna or open waveguide radiating power. Refer to the table below for hazard zones. When it is necessary to work on the Scanner Unit, make sure that radar is switched OFF, and that both the Mains Isolator and the Scanner Control Unit are turned to the OFF position.

Never look directly into an open waveguide.

Radar and other forms of RF radiation can cause Cardiac Pacemakers to malfunction. If you use a Cardiac Pacemaker and suspect a malfunction, leave the vicinity of the radar system immediately and seek medical advice.

Most countries accept that there is no significant radiation hazard at RF power density levels of up to 10 mW/cm².

Antenna Length	Hazard Zones	
	10 mW/cm ²	1 mW/cm ²
1.2 m X-Band	1.7 m	17 m
1.8 m X-Band	1.05 m	10.5 m
2.4 m X-Band	0.75 m	7.5 m
2.7 m S-Band	0.73 m	7.3 m
3.7 m S-Band	0.55 m	5.5 m

CAUTION: Electrostatic Sensitive Devices (ESSDs)

This equipment contains ESSDs. Take care not to damage these devices by discharge of electrostatic voltages.

REVISION RECORD

Suf	Rev	Issue Date	Date Incorporated	Incorporated By

PREFACE

ABOUT THIS MANUAL

The structure of this manual and the design of the pages can help you to find the information that you need. Consistent presentation techniques are used throughout the manual, to make it easy to use.

Note – *Depending on the composition and configuration of your radar installation, not all of the facilities presented in this User Guide may be applicable to your system.*

This manual is intended to be used by the Radar Operator and is divided into chapters as follows:

- Chapter 1 - **An Overview**
- Chapter 2 - **Getting Started**
- Chapter 3 - **Basic Operation**
- Chapter 4 - **Ship's Heading and Speed**
- Chapter 5 - **Presentation, Motion, Vector and Trail Modes**
- Chapter 6 - **EBLs, ERBLs and VRMs**
- Chapter 7 - **Acquisition, Plotting and Zone Functions**
- Chapter 8 - **Target Functions**
- Chapter 9 - **Navigation**
- Chapter 10 - **Maps**
- Chapter 11 - **Parallel Index Lines**
- Chapter 12 - **Tools**
- Chapter 13 - **Alarms**
- Chapter 14 - **System**
- Chapter 15 - **References**
- Annex A - **Search and Rescue (SART) Detection**
- Annex B - **Static Site Radar Installations**

NOTICE

Northrop Grumman Sperry Marine B.V. have a policy of continuous development. This may lead to the equipment described in this manual being at variance with equipment manufactured after its publication.

CONTENTS

Chapter 1 **An Overview**

Basic System	1-2
Interswitched System.....	1-2
Control Panels	1-4
Manual	1-4
System Features.....	1-5
Common Features.....	1-6
Radar Specific Features.....	1-8

Chapter 2 **Getting Started**

Switching On the Radar	2-2
Master Radar Start Up	2-3
Slave Radar Start Up	2-3
Standby Mode.....	2-4
Using the Radar Controls.....	2-6
Controls Panels	2-6
The On-screen Cursor.....	2-7
Help Area	2-9
Soft Keys and Fixed Menus	2-10
Restricted Access when in Edit Mode	2-10
Drop Down Menus.....	2-11
Selecting a Display Mode of Operation.....	2-11

Chapter 3 **Basic Operation**

Introduction	3-2
Returning to Standby Mode	3-3
Transceiver Selection	3-3
Radar Transmission Pulse Length.....	3-6
Range Scales & Range Rings	3-7
Heading Line (HL).....	3-9
Stern Line (SL)	3-9
Performance Monitoring.....	3-10
Events (ATA and ARPA only)	3-12
Video Processing Controls.....	3-13
Video Gain and Anti-Clutter Controls	3-13
Enhanced Video Mode	3-15
Transceiver Fine Tuning	3-16

User Specified Data.....	3-17
Own Ship's Position	3-17
Time and Datum	3-18
Alarms.....	3-18
Invalid Latitude	3-18
Waypoint Data	3-19
Wind and Depth	3-19
Off-centring the Picture.....	3-20
Centring the Video Display	3-20
Maximum View.....	3-21
Automatic Identification System (AIS) information display	3-21
Brilliance Control	3-22
Day/Night Selection	3-23
Changing the Relative Brilliance Settings	3-23
Returning to the Default Brilliance Settings.....	3-23
Panel Brilliance	3-24

Chapter 4 Ship's Heading and Speed

Introduction.....	4-2
Heading Display	4-2
Compass Errors	4-2
Compass Alignment.....	4-2
Course Over Ground.....	4-3
Magnetic Headings	4-3
Entering a Manual Variation.....	4-4
Speed Display	4-5
MANUAL Speed Mode.....	4-7
ECHO REFERENCE Speed Mode	4-7
Manual Set and Drift	4-8
Auto Set and Drift.....	4-8

Chapter 5 Presentation, Motion, Vector and Trail Modes

Introduction.....	5-2
Presentation Modes.....	5-2
Course-UP Reset.....	5-3
Motion Modes	5-4
Vector Modes	5-5
Trails Mode.....	5-8
Trail Time	5-8
Warning Prompts.....	5-10
Presentation Mode Warnings.....	5-10
Motion Mode Warnings	5-10

Contents

Chapter 6 **EBLs, ERBLs and VRMs**

Introduction	6-2
Electronic Bearing Line (EBL)	6-2
Variable Range Marker (VRM)	6-4
Rapid Range and Bearing Readings	6-5
Options	6-5
Defaults	6-6
Warning Prompt	6-7

Chapter 7 **Acquisition, Plotting and Zone Functions**

Introduction	7-2
Electronic Plotting Aid (EPA) Radars	7-3
Manual Plotting of Targets (EPA)	7-3
Manually Plotting Alarm Symbols	7-4
Plot Data (EPA)	7-5
Manually Plotted Target Data	7-5
Closest Approach and Bow Crossing Limits	7-5
Guard Zones (EPA)	7-6
Automatic Targeting and Radar Plotting Aid Radars (ATA/ARPA)	7-8
Targeting Functions (ATA/ARPA)	7-8
AIS Functions (Option)	7-9
Target Alarm Symbols	7-11
Manual Acquisition of Targets (ATA/ARPA)	7-12
AIS Display of Targets	7-13
Sleeping Target	7-13
Activated Target	7-13
AIS Target Symbols	7-15
Auto-Acquisition Zones (ATA/ARPA)	7-16
Annular Zone Editing	7-18
Changing the Start/Stop Bearing	7-18
Changing the Range of a Zone	7-18
Altering the Depth of the Zone	7-18
Creating a New Zone	7-18
Polygonal Zone Editing (ATA/ARPA)	7-19
Target Data (ATA/ARPA)	7-20
Acquired Target Data	7-20
Closest Approach and Bow Crossing Limits	7-21
Multiple Target Displays (ATA/ARPA)	7-22
Viewing Multiple Targets in Order of CPA	7-22
Viewing Multiple Targets in Order of Range	7-22
Viewing up to 6 User Selected Targets	7-22
AIS Information Display (Option)	7-23

Chapter 8 Target Functions

Introduction.....	8-2
Accessing TARGET Functions	8-2
TARGET Menu	8-2
EPA(L) Menu	8-3
Past Position Dots (ARPA only)	8-3
Target IDs.....	8-4
To Change Display of Target Names and IDs (ARPA and ATA only).....	8-4
To Change Display of PLOT IDs (EPA only).....	8-4
Naming Targets (ARPA and ATA only)	8-4
Cancel All Plots (EPA only)	8-4
Cancelling All Tracked Targets (ARPA and ATA only).....	8-5
Targets Currently Being Tracked (ARPA and ATA only).....	8-5
Target Repair (ARPA and ATA only).....	8-5
AIS Menu (Option).....	8-6
Turning AIS feature ON and OFF	8-6
AIS Integrity	8-6
Target Association	8-7
AIS Target Totals	8-7
Own AIS Position Menu	8-8
Own AIS Vessel Menu	8-8
Test Targets (ARPA and ATA only).....	8-9
Limits & Settings Menu.....	8-10
Automatic Dropping of Targets (ARPA and ATA only).....	8-10
Vector Timeout.....	8-11
OS Vector Arrow	8-11
Vector Type.....	8-12
CPA, TCPA, BCR and BCT Limits	8-12
Trial Manoeuvres (ARPA only)	8-13
Running a Trial Manoeuvre.....	8-13

Chapter 9 Navigation

Introduction.....	9-2
Turning the Navigation Display ON and OFF.....	9-2
Accessing the NAVIGATION Menu.....	9-3
Track History (ARPA and ATA only).....	9-4
Track Segments.....	9-4
Time Marks	9-4
Event Marks	9-4
Starting/Stopping a Recording	9-7
Filenames	9-7
Setting the Time Interval	9-7
Selecting Targets for History Tracking	9-8
Deselecting Targets from History Tracking.....	9-8

Contents

Event Recording	9-9
Removing Current Track from Display	9-9
Replaying a Recorded Track	9-9
Off Line Centre (Standby Mode)	9-10
Replaying Large Tracks	9-10
Switching the Replay OFF	9-11
Deleting a Track File from a Memory Card	9-11
Setting System Time and Date	9-12
Entering a UTC Date	9-12
Entering a Local Time Offset	9-13
Entering a Local Time and Date	9-13
Position	9-14
Navigation (NAV) Position Mode	9-15
Own Ship's Position	9-15
Estimated Position/Dead Reckoning (EP/DR) Mode	9-16
Cursor Display	9-17
Routes	9-18
Route Type	9-19
External Routes	9-20
Waypoint Data	9-20
Route Data	9-20
Selecting the LEG TYPE	9-21
Sailing Alarms	9-21
Internal Routes (ARPA only)	9-23
Selecting an Internal Route from a Memory Card	9-24
Sailing an Internal Route	9-25
Joining a Route	9-25
Creating and Editing Internal Routes	9-27
Setting the OFF-LINE CENTRE for Editing in Standby Mode	9-28
Route Editing Procedure	9-29
Adding a Waypoint into a Route	9-29
Single Leg Routes (ARPA only)	9-33
Setting the Single Leg Waypoints	9-33
Sailing a Single Leg Route	9-34
Position Database	9-35
Route and Waypoint Transfer (ARPA only)	9-39
Transferring Routes and Waypoints	9-39

Chapter 10 Maps

Introduction..... 10-2

 Offsets..... 10-2

 Layers 10-2

 Guard Lines 10-3

 Datums..... 10-3

 Turning the Maps Display ON and OFF 10-3

MAP Facilities..... 10-4

 Selecting Maps and Folios from a Memory Card 10-4

 Offsetting Map position 10-5

 Selecting Map Layers 10-6

 Activating and De-activating Guard Lines 10-6

Deselecting Maps 10-7

Deleting a Map from a Memory Card 10-7

Creating and Editing Maps/Layers 10-8

Editing a Selected Map..... 10-9

Adding Lines and Symbols to a Map 10-12

Deleting Lines and Symbols from a Map 10-15

Moving Lines and Symbols on a Map..... 10-16

Modify Map Symbols 10-16

Saving a Map..... 10-17

Creating and Editing Folios 10-17

Creating and Deleting Guard Lines 10-20

Navline Interface..... 10-23

 Mode Selection 10-23

MAP Facilities for EPA(L) Radars 10-25

Warning Prompts..... 10-27

Chapter 11 Parallel Index Lines

Introduction..... 11-2

 Turning the Index Lines Display ON and OFF 11-2

Accessing the Index Lines Menu..... 11-3

 Selecting a Group of Index Lines from a Memory Card 11-4

Index Line Editing 11-4

 Changing the Bearing of Selected Line 11-5

 Changing the Range of Selected Line 11-6

 Changing the Line Type of Selected Line 11-6

 Adding a Line 11-6

 Removing a Line 11-7

 Removing ALL Lines..... 11-7

 Saving a Group of Index Lines to a Memory Card 11-7

 Loading a Group of Index Lines from a Memory Card..... 11-8

 Unloading a Group of Index Lines 11-8

Warning Prompt..... 11-8

Contents

Chapter 12 **Tools**

Introduction	12-2
Accessing the TOOLS	12-2
Rotating Cursor.....	12-3
To Select HALF or FULL Circle Cursor	12-3
Marks	12-4
VMS Graphics (ATA/ARPA only)	12-5
Constant Radius Turn	12-6
Radius Turn Menu.....	12-6
Setting the New Course	12-7
Setting the Turn Radius.....	12-8
Setting the Start Line.....	12-8
Aligning to Own Ship's Course.....	12-9
Rates of Turn.....	12-9
Standard Rate of Turn.....	12-9
Ship's Profile	12-10

Chapter 13 **Alarms**

Introduction	13-2
Types of Alarm	13-2
Alarm Display.....	13-2
No Alarms	13-2
Unacknowledged Alarms	13-3
Acknowledged Alarms	13-3
Alarm Facilities.....	13-3
The Alarm BUZZER	13-4
To Set the Watch Alarm Interval	13-4
List of Alarms	13-5

Chapter 14 **System**

Introduction	14-2
Accessing the SYSTEM Facilities	14-2
Degaussing.....	14-3
Memory Card Facilities	14-3
Card STATUS	14-4
File Management.....	14-4
Selecting a FILE TYPE.....	14-4
Deleting Files.....	14-5
Copying Files.....	14-5
Moving a File	14-5
Renaming a File	14-6
To Copy all the files from one Card to the Other.....	14-7
To Initialise a Card	14-7
Additional Facilities	14-8

Video Setting Facilities	14-8
TX Setting Facilities	14-8
Performance Monitor	14-8
System Status Display	14-8
Test Data Facilities	14-8

Chapter 15 References

Introduction	15-2
Drop Down Menus	15-2
Selecting an Item from a Scrolled List	15-2
Drop Down Keypads	15-3
Numeric Keypads	15-3
Entering a Parameter Value	15-3
Correcting a Wrong Selection	15-4
Entering a Negative Value	15-4
Closing the Keypad	15-4
Memory Cards	15-5
Filenames and Alphanumeric Keypads	15-5
Memory Card Functions	15-6
SAVE	15-6
DELETE	15-6
ERROR	15-7
Write Protect Switch	15-7
Help Line Warning Prompts	15-8

Annex A Search and Rescue (SART) Detection

Introduction	A-2
Radar Range Scale	A-2
SART Range Errors	A-3
Radar Bandwidth	A-3
Radar Side Lobes	A-3
Detuning the Radar	A-3
Video Gain	A-4
Anti-clutter Sea Control	A-4
Anti-clutter Rain Control	A-4

Annex B Static Site Radar Installations

Introduction	B-2
Static Site Radar Operation	B-2
Motion and Presentation Modes	B-2
Position Modes	B-3
Heading Mode	B-3
EBL reciprocal bearing	B-3

Intentionally Blank

CHAPTER 1

An Overview

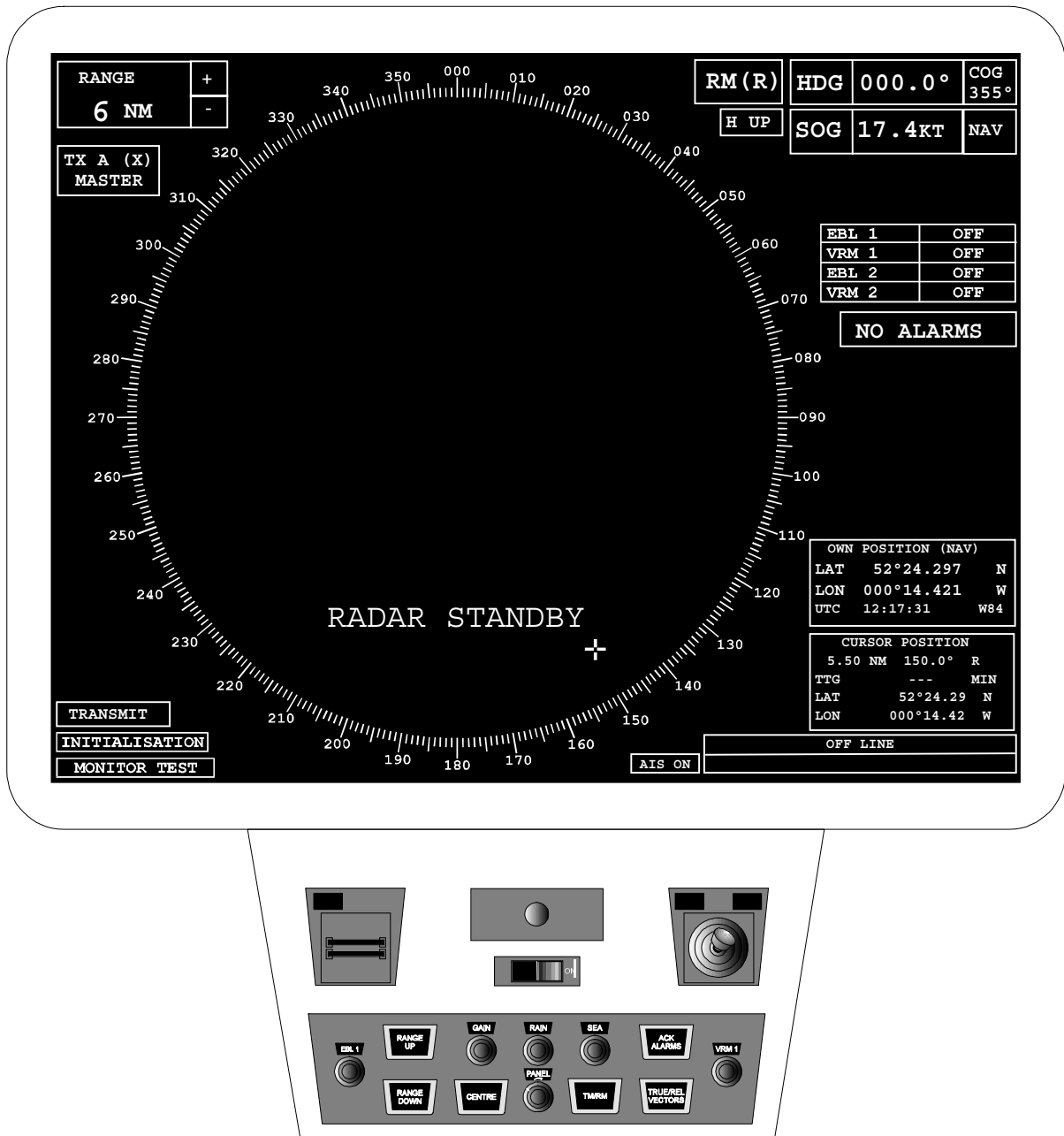

Covered in this chapter:

- The basic system.
- The interswitched system.
- Control panels.
- Systems features.

Basic System

The major components of a basic BridgeMaster E Radar installation (see diagram opposite) are as follows.

Display Unit	
Colour Display*	180mm, 250mm or 340mm
Control Panel(s)	Simple Control Panel (with joystick or tracker-ball, and optional memory card reader) and Dedicated Control Panel (optional)
Scanner Unit	
Antenna Unit	10cm S-Band (9 or 12 ft aperture) or 3cm X-Band (4, 6 or 8 ft aperture)
Turning Unit	Standard or High Speed
Transceiver Unit	Masthead (mounted as an integral part of Turning Unit) or Bulkhead (mounted as a separate unit)
Performance Monitor	If fitted, the performance monitor antenna is mounted on the Turning Unit.

*The dimensions given in mm relate to the diameter of the video circle.

There will also be a Scanner Control Unit for switching the scanner ON and OFF (S-Band scanner units only), and a Mains Isolation Switch.

Interswitched System (Not available with EPA(L) Systems)

The basic, single-scanner/single-display configuration can be expanded by the introduction of an Interswitch Unit and additional scanners and displays (see diagram opposite). The arrangement shown uses two scanners and four display units with a 2-way interswitch unit. A six way interswitch unit is available for systems with a maximum of six scanners and six display units.

A display unit can be connected via the interswitch to any one of the scanner units, and can be selected from that display as the **master** display for controlling that scanner, or as a **slave** display. The master/slave status of all displays and their specific scanner couplings, can be monitored from any display unit in the system.

Basic System

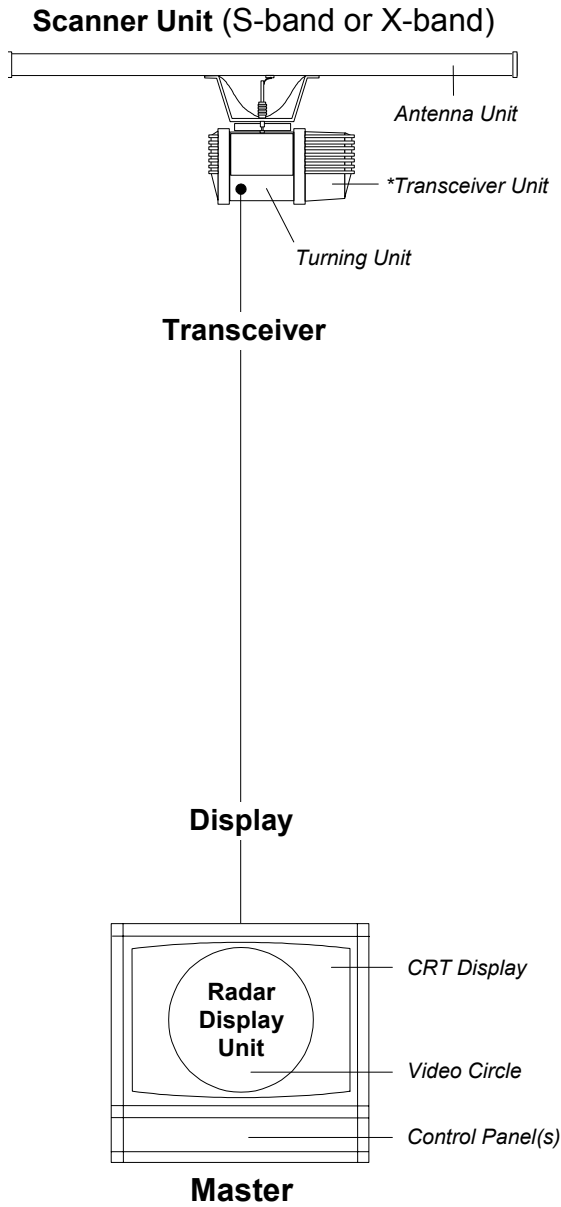

Interswitched System

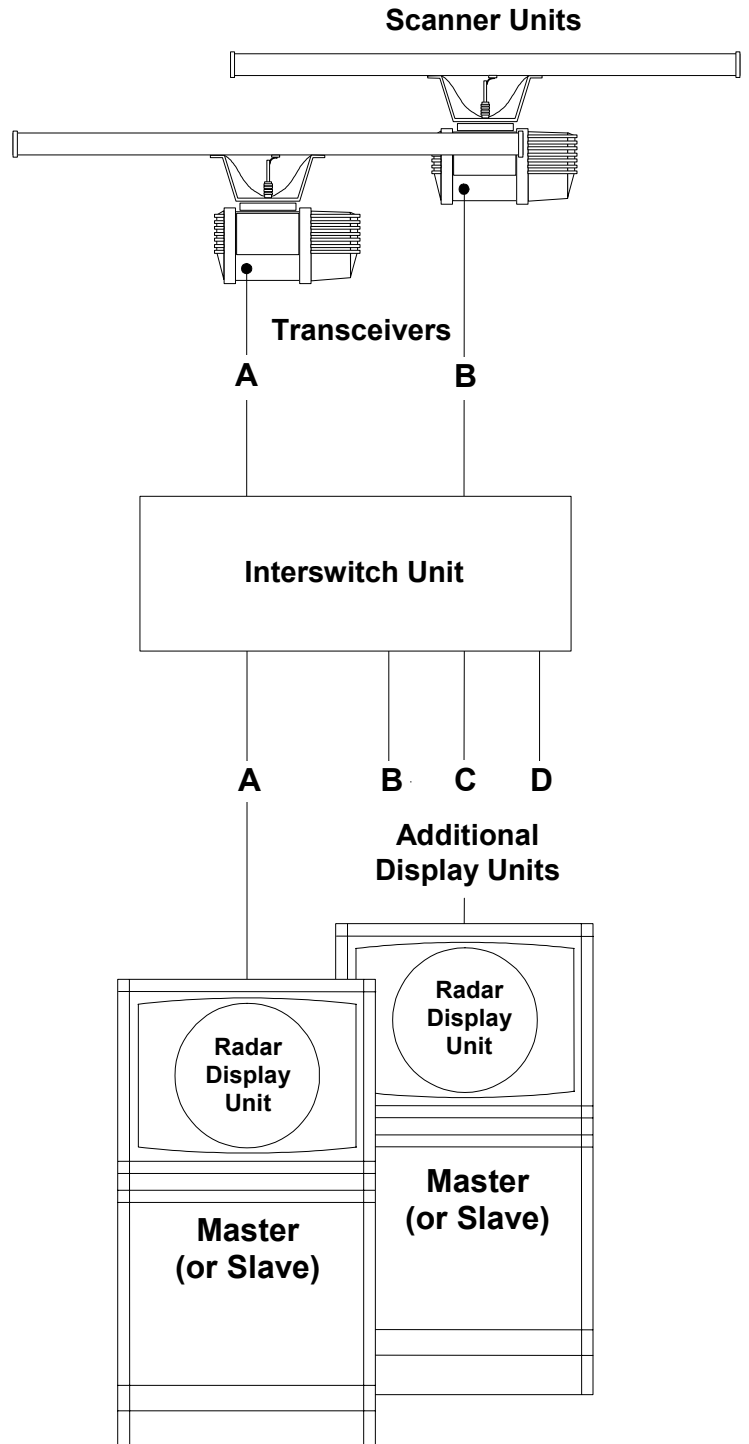

*The Transceiver may be an integral part of the turning unit, or a bulkhead mounted unit.

A display unit can only be connected to one scanner at a time, and only a Master display has full control of the scanner. The controls, which are available at a Master display but NOT at a Slave display, are as follows,

- switching the transceiver between standby and transmit mode
- selection of transmission pulse-length
- tuning the transceiver
- selecting Manual or AFC mode for tuning
- tuning the performance monitor

Control Panels

The Display Unit is always fitted with a Simple Control Panel which is mounted immediately below the screen. This panel contains a simple pointing device (a joystick or tracker-ball referred to as the cursor control) with two associated keys (left and right) which are used to control the radar and its display. The panel may also contain a two memory-card reader. Memory cards are used for storing and retrieving information such as maps and recorded tracks.

An optional Dedicated Control Panel may also be fitted. This dedicated panel contains individual controls for specific functions which would normally be accessed and adjusted using the cursor control and associated left/right keys of the Simple Control Panel (see diagram below).

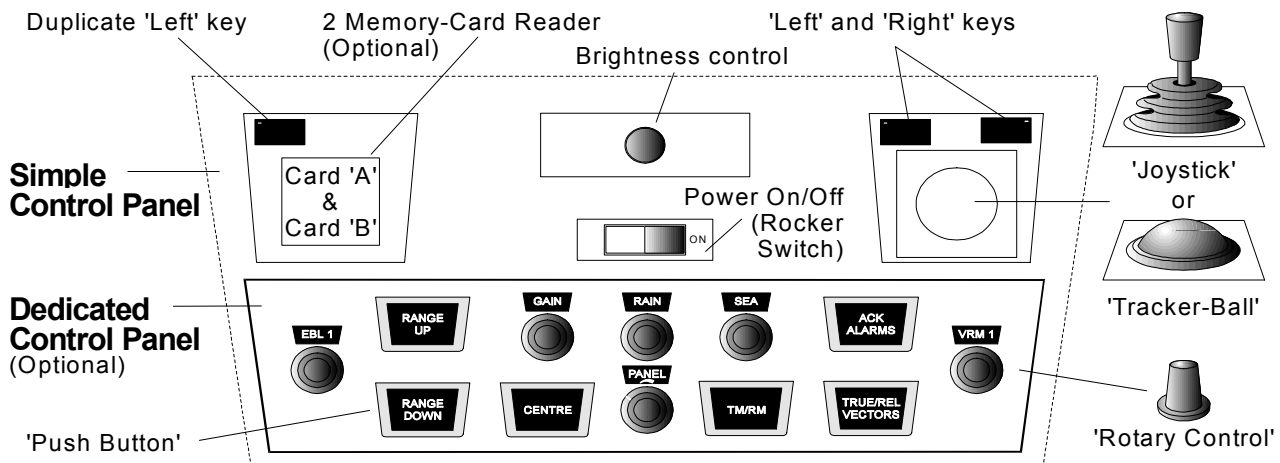

Manual

This manual covers all current versions of BM E software available. Some menus, text and screen displays vary between versions. Any operational differences are noted under the individual sections.

System Features

The BridgeMaster E Radar is available in any one of the following configurations:

- EPA(L) (Electronic Plotting Aid)
- EPA (Electronic Plotting Aid)
- ATA (Automatic Tracking Aid)
- ARPA (Automatic Radar Plotting Aid)

The features applicable to each configuration are given in the following tables. The first table, headed 'Common Features', lists the features which are applicable to all radar configurations. The second table, 'Radar Specific Features', indicates those features which apply to specific radar configurations.

Common Features

The following table lists the features which are common to all radar configurations.

Feature	Additional details
Transceiver control	Selection and set up. Manual/automatic tuning.
Video processing controls	Video gain. Manual/automatic anti-clutter sea/rain control. Enhanced video mode.
Display controls	Picture brilliance (day/night selection). Manual/automatic degaussing facility. Displaying/hiding heading line and synthetics. Off-centring (max view) the radar picture.
Defining and displaying user specified data	Own ship's position. Waypoint data. Wind and depth data.
Range scale selection	Range in nm, km or sm (set during initialisation). Range rings on or off.
Ship's heading and speed display	Compass alignment. Selection of speed mode. Applying manual set and drift.
Selection of presentation mode	Head-up (unstabilised). North-up or Course-up (stabilised).
Selection of motion mode	Relative motion (relative trails) – RM(R). Relative motion (true trails) – RM(T). True Motion – TM.
Selection of vector mode	Selection of true (T) or relative (R) vectors. Selection of vector time.
Selection of trails mode	Short trails. Reset trails. Long trails. Permanent trails. Off.
Defining and displaying EBLs, VRMS & ERBLs	2 Electronic bearing lines – EBL 1 & EBL 2. 2 Variable range markers – VRM 1 & VRM 2. Each EBL/VRM pair can be displayed as a combined ERBL – ERBL 1 and/or ERBL 2.
Navigation facilities	Position as derived from: Navigational sensor An estimated position Display of external route data Defining the system time and date stamp.
Defining and displaying maps	Selecting map for display. Displaying lines and symbols. Creating/editing maps.
Displaying parallel index lines	Defining line type/position. Displaying at least four index lines.

Feature	Additional details
System tools	Display of rotating half or full cursor. Defining and displaying marks. Constant radius turn. Display of ship's profile.
Extensive alarm indications	Displaying the current unacknowledged alarm with highest priority. Facility for acknowledging alarms. Display list of acknowledged alarms. Alarm buzzer facility. Watch alarm facility.
Performance monitor	Separate monitors for system and receiver. Manual tuning.
Extensive monitoring and test facilities	Built in self tests (BIST).
Help line warning prompts	Permanent and temporary prompts.

Radar Specific Features

The following table lists those features which apply to specific radar configurations.

Feature	EPA(L)	EPA	ATA	ARPA
Manual plotting of targets	•	•		
Defining closest approach and bow crossing	•	•	•	•
Defining guard zones	•	•		
Manual/automatic acquisition of targets			•	•
Defining auto acquisition zones			•	•
Defining polygonal zones			•	•
Multiple target displays			•	•
Carrying out trial manoeuvres				•
Naming of targets			•	•
Displaying target IDs	•	•	•	•
Displaying past position dots				•
Test targets facility			•	•
Output of NMEA target data			•	•
2 Memory-card facility		•	•	•
Interswitch capability		•	•	•
Map guard lines		•	•	•
Remote alarm – with Interface Unit		•	•	•
Track history – record and replay			•	•
VISION/Video Processing (optional)			•	•
Internal routes				•
Creating/editing map folios		•	•	•
AIS information interface (optional)			•	•

CHAPTER Getting Started 2

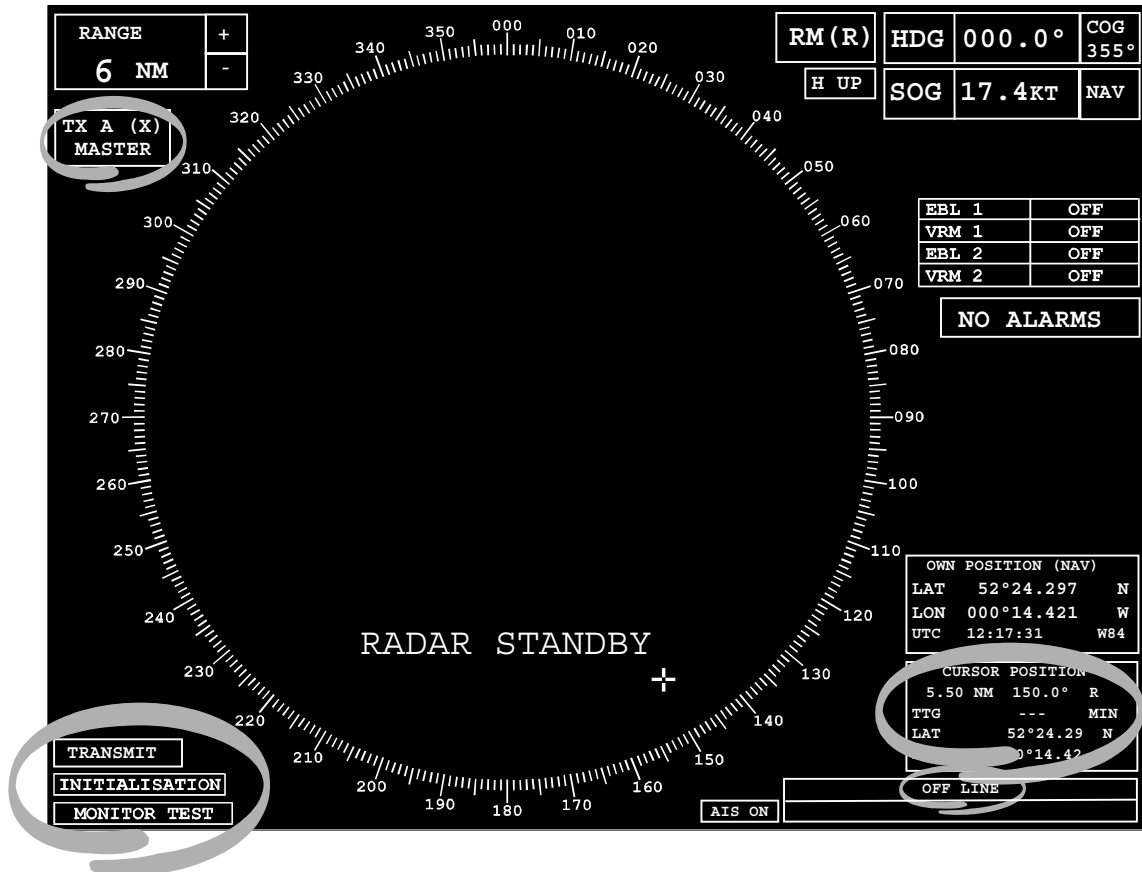

Covered in this chapter:

- Switching on and starting up the radar.
- A description of standby mode.
- How to operate the radar using the screen controls and the joystick/trackerball.
- Selecting different modes of operation.

Switching On the Radar

Press the On/Off switch to turn on the radar display.

During the start-up sequence, the display is blanked for 20 seconds.



The messages which follow depend upon the set up chosen during the previous initialisation. An indication of this set up is given in the top left hand corner of the screen - see example left.

The **TX n (X)** or **(S)** caption, relates to the type of transceiver the system is using.

The **MASTER** or **SLAVE** caption indicates the type of display. A master display has control over a radar systems antenna and transceiver. With a **master** display you can switch to transmit, ie start the antenna rotating and the transceiver transmitting radar pulses. It also allows you to select the length of the radar pulse transmitted, to tune the transceiver, and to monitor the performance of the radar.

A **slave** display has no control over the antenna and transceiver. It must be used in conjunction with a master display. The pulse length, tuning and performance monitoring are all controlled by its associated master display. The controls associated with these functions are disabled on a slave display.

Master Radar Start Up

After the initial 30 seconds, the radar warm up message is displayed together with a 3-digit counter.

RADAR WARMING UP
PLEASE WAIT
nnn

The counter (*nnn*) will increment every second up to a maximum of 999 during the period that the transceiver timer is running.

From Version 5.01 software whenever the display enters the standby mode, it will also display a message "Before using this radar, please read the manual". This message will be removed on the first valid key press.

For a stand alone system the transceiver takes approximately 3 minutes (180 seconds) to warm up. On an interswitched system, this time will depend on when the interswitch is first powered up, and may be shorter.

When the transceiver has warmed up and is available to transmit, the timer stops and the radar standby message is displayed. If the transceiver is already warmed up and available to transmit, after the initial 30 seconds, the standby message is displayed immediately.

Slave Radar Start Up

After the initial 30 seconds, the radar standby message is displayed.

Standby Mode

The radar always powers up in standby mode.

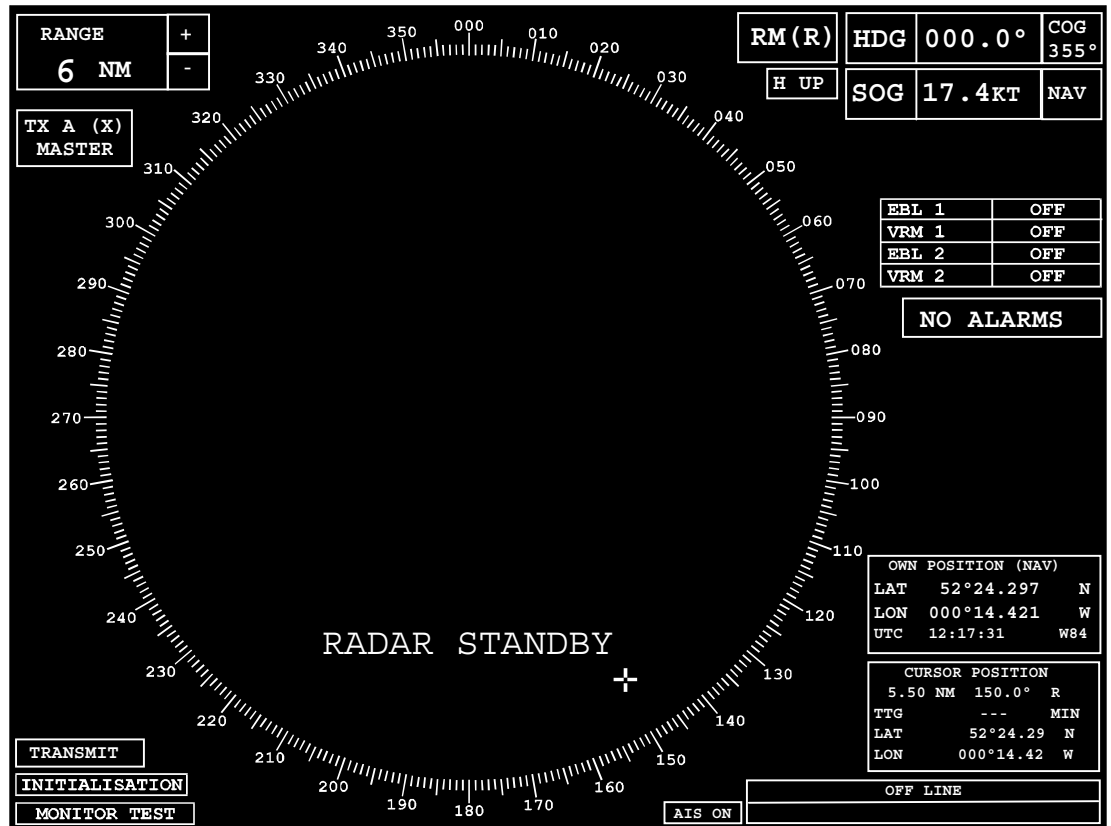

From standby, the other display modes can be selected.

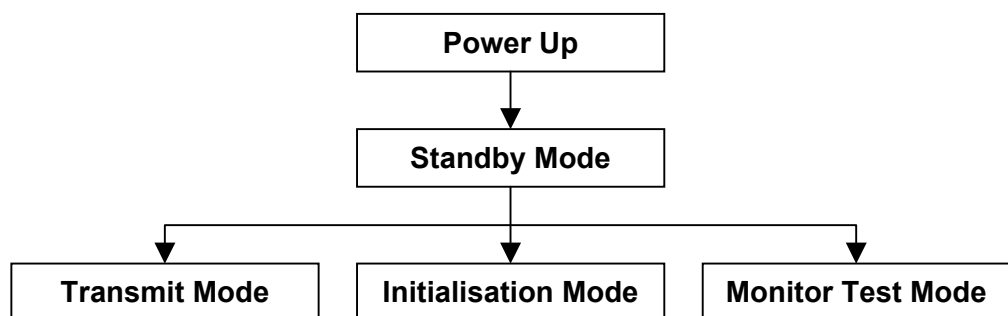

In standby mode, a number of functions are available which allow the display to be set up for operation. For example, the displayed radar range can be set, and maps can be created and stored for future use.

The following functions can be accessed from standby mode.

Transceiver Selection	Chapter 3
Brilliance	Chapter 3
Cursor data	Chapter 3
Range selection	Chapter 3
User specified data	Chapter 3
Heading	Chapter 4
Speed	Chapter 4
Presentation & Motion modes	Chapter 5
EBL/VRM	Chapter 6
Target	Chapter 8
Navigation	Chapter 9
Maps	Chapter 10
Parallel index lines	Chapter 11
Alarms	Chapter 13
System	Chapter 14

These functions are described in the chapters indicated.

If you are not familiar with using the radar, it is strongly recommended that you read the following section **Using the Radar Controls**. This describes how to interact with the display in order to operate the radar. This is applicable to all its functions and to all modes of operation.

If you are already familiar with the radar operation and want to start transmitting, go straight to the section on **Selecting a Mode of Operation**.

Using the Radar Controls

Controls Panels

There are two types of control panel in current use for controlling the radar, a **Simple Control Panel** and an optional **Dedicated Control Panel**.

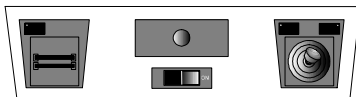
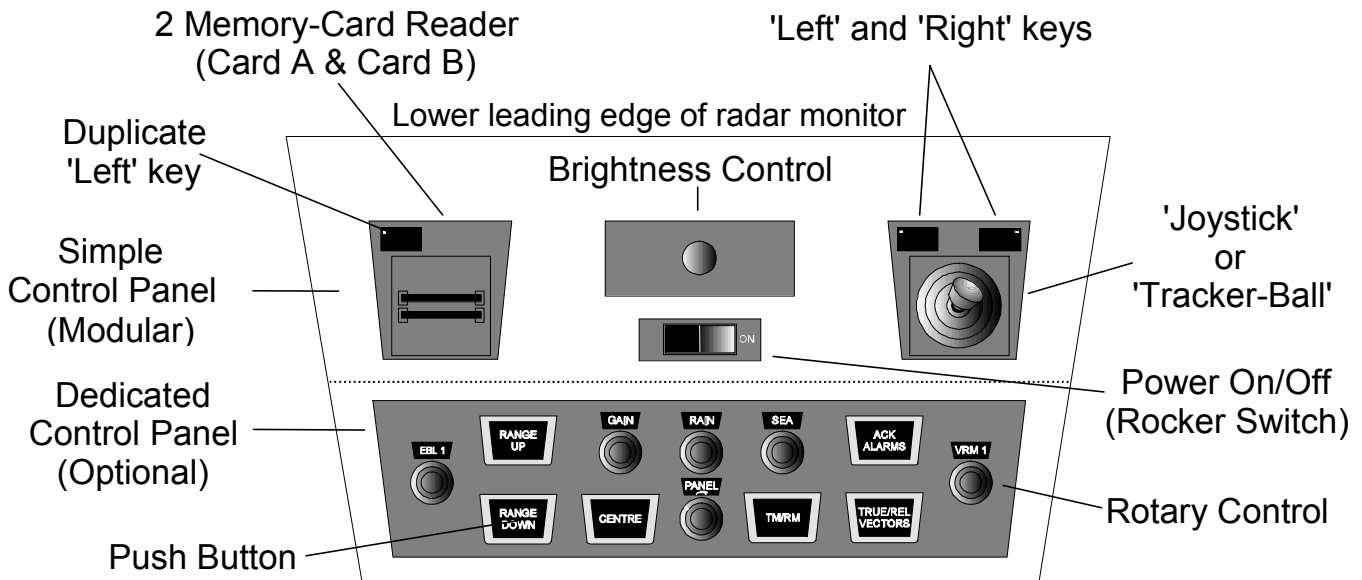

Simple Control Panel

Simple Control Panel

The simple control panel is made up of a number of modules which are usually mounted immediately under the display monitor. A simple pointing device (joystick or trackerball), with two associated keys (left and right), is used to control the radar and its display. See diagram above. The joystick/trackerball controls the position of the on-screen cursor which is displayed as a small white arrow when positioned outside the radar circle, see **The On-screen Cursor** later in this chapter.

Selections are made by positioning the on-screen cursor over an object or caption and clicking (press and release) with the 'left' key. If a Memory-card Reader is fitted, the left key is duplicated on the left hand side of the control panel, to enable two handed operation. The 'right' key is used on some items to provide additional functionality when available.

Note – Throughout this manual, instructions to 'left click' or 'right click' relate to a press-and-release of either of the left keys or the right key. Similarly, references to the 'cursor

control' relate to the joystick or trackerball depending on which is fitted.

Optional Dedicated Control Panel



Dedicated Control Panel (Optional)

A Dedicated Control Panel, which contains a number of additional push buttons and rotary controls, can be fitted as an optional extra. The Simple Control Panel is always fitted, see diagram on previous page.

The Dedicated Control Panel provides individual tactile controls for specific functions. These functions would normally be accessed and adjusted using the cursor control and associated left/right keys of the Simple Control Panel. The controls available are as follows:

Push Buttons: RANGE UP, RANGE DOWN
TM/RM, TRUE/RELATIVE VECTORS
CENTRE, ACK ALARM

Rotary Controls: GAIN, RAIN (Clutter), SEA (Clutter)
EBL 1, VRM 1, PANEL (Brightness)

The On-screen Cursor

When the on-screen cursor is outside the video circle, it is displayed as a small white arrow, referred to as the **screen cursor** - see examples below. As the cursor passes into the video circle it changes and is displayed as a small white cross, referred to as the **video cursor**.

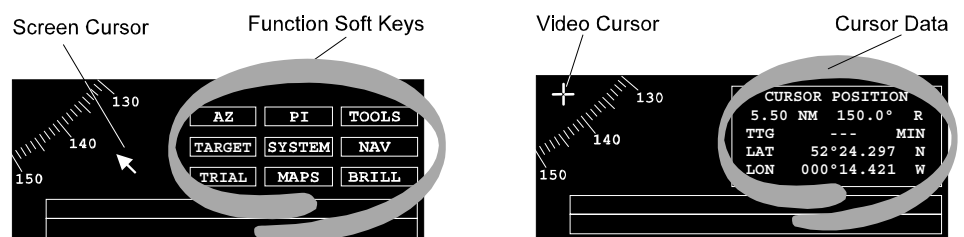

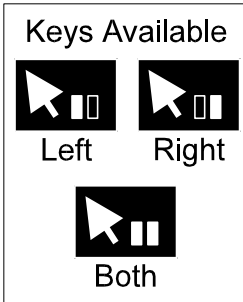

Screen Cursor

As the screen cursor moves over a caption or item which can be accessed, its box is highlighted (drawn in white), and two small boxes (representing the left and right keys) appear next to the arrowhead cursor. One or both of these boxes is filled in white to indicate which key(s) are active and available for selection, see example left.

Note – For reasons of clarity and to avoid conflicting information, the screen cursor is shown without its associated left/right key boxes in the diagrams throughout the rest of the manual.

If a caption box is not highlighted as the cursor passes over it, it indicates that the caption or item inside the box cannot be accessed in the current mode.

Drop down menu options are highlighted in yellow as the cursor passes over them. If a particular option is not available, its text is shown darker, and it will not be highlighted. Options which can never be selected because of the current radar configuration, are NOT shown.

If an adjustable parameter is selected, the cursor will disappear and the parameter is displayed in yellow (as a number or control bar). If an adjustment is not made within 10 seconds, the parameter will be automatically deselected, and the cursor will reappear.

Video Cursor

Whenever the video cursor is displayed, a dialog box giving a readout of the cursor's position within the video circle, replaces the usual function soft keys shown in the bottom right hand corner of the display. By default this box gives cursor range and bearing (from own ship) and cursor lat/long. SC1.xx and V4.xx software variants do not show the time to go to cursor position (TTG). Other display options are available by selecting CURSOR DISP on the NAV soft key menu.

Note – Soft keys are small, boxed areas of the screen, usually containing a single caption, which respond in much the same way as the dedicated function keys of a computer keyboard.

In TRANSMIT mode, the range and bearing of the cursor are relative to own ship's position. In STANDBY mode, the range and bearing are relative to the centre of the video circle.

Note – *If, when in TRANSMIT, own ship's position is lost, the compass is unaligned, or there is a compass error, the lat/lon readings are replaced by dashes.*

Help Area

A help area consisting of two lines of yellow text is given in the bottom right hand corner of the display.

```
This line is used for PERMANENT PROMPTS  
This line is used for TEMPORARY PROMPTS
```

This area is used to provide prompt information when, for instance, the user is trying to make a selection which conflicts with the existing set up. In the following chapters, most of the prompts the user will encounter are identified and explained. The prompts are by nature brief but are generally self explanatory.

Permanent prompts, when they exist, are displayed on the upper of the two lines. Temporary prompts are displayed on the lower line. In the default condition both lines are blank, unless in Standby when the permanent prompt OFF LINE is displayed.

```
OFF LINE
```

When the target (ARPA/ATA) or manual plotting (EPA) synthetics (information displays) are turned OFF, an appropriate message is permanently displayed on the upper line.

```
EPA data off
```

```
Target display off
```

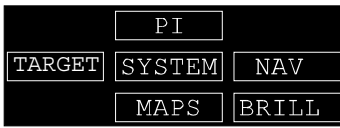
Soft Keys and Fixed Menus

A series of functional soft keys are displayed in the bottom right hand corner of the display.

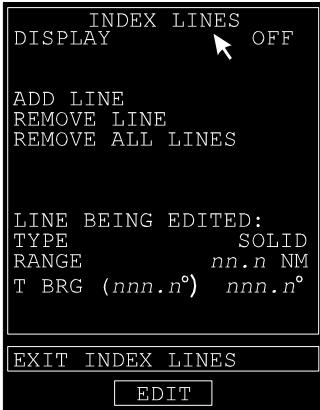

A **left** click on any one of these keys will reveal a fixed menu and a new set of soft keys associated with that menu. The menu appears in the area immediately above the soft keys. As an example, the fixed menu and soft key for the PI option are shown on the left.

A **right** click on some of the function soft keys will provide additional functionality, for example switching the Index Line display in the video circle ON or OFF.

Items from the menu are usually selected by a left click.

Restricted Access when in Edit Mode

Some of the soft key functions permit editing as part of their functionality. For example, Guard Zone or Auto Acquisition or Zone Editing (Chapter 7), Map and Folio Editing (Chapter 10) and Index Line Editing (Chapter 11). When an edit mode is selected, a permanent prompt appears in the help area, and access to some of the normal operating facilities is restricted.



As editing is usually performed within the video circle, the following picture related facilities are unavailable during editing.

- Off-centring own ship by dragging.
- Changing ERBL/VRM by dragging.
- Acquiring or Cancelling Targets.
- Selecting from the Target Tote.
- Selecting a new Speed Mode.
- Aligning the Compass.
- Performance Monitoring.

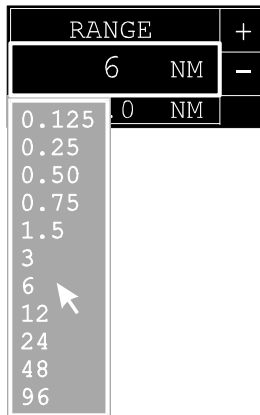

Drop Down Menus

Where there are a number of fixed selections for a particular parameter, for example RANGE in the top left hand corner of the display, a left click will reveal a drop down menu of the alternatives available.

A drop down menu is usually displayed in the vicinity of the screen cursor when the selection is made. Once a menu is displayed, the cursor is restricted to the area within the menu and selections are made with a left click. A right click will close the menu without taking further action (ie Cancel).

Further information on drop down menus and keypads, is given in Chapter 15.

Selecting a Display Mode of Operation

From the **Standby Mode**, there are three display mode selections available.

TRANSMIT

The normal operational mode. The antenna is rotating and the transceiver transmits and receives radar pulses enabling a radar picture to be displayed.

INITIALISATION

The system initialisation mode. This is used to set up the system parameters during installation. (See Ship's Manual, Chapter 4).

MONITOR TEST

The display monitor test mode. This is used in setting up the monitor, eg Geometry, pre-set contrast etc. (See Ship's Manual, Chapter 5).

The soft key for selecting these modes of operation are located in the bottom left hand corner of the display.



To Select a Mode

1. Use the cursor control to position the screen cursor over the relevant soft key for the mode required.
2. Left click to select.

Notes – *A slave display can only be switched to TRANSMIT if its associated master display is in Transmit mode. If TRANSMIT is selected on a slave display when its master radar is still in Standby (NOT transmitting), the following prompt is displayed and the slave remains in Standby.*

Master in standby

CHAPTER 3

Basic Operation

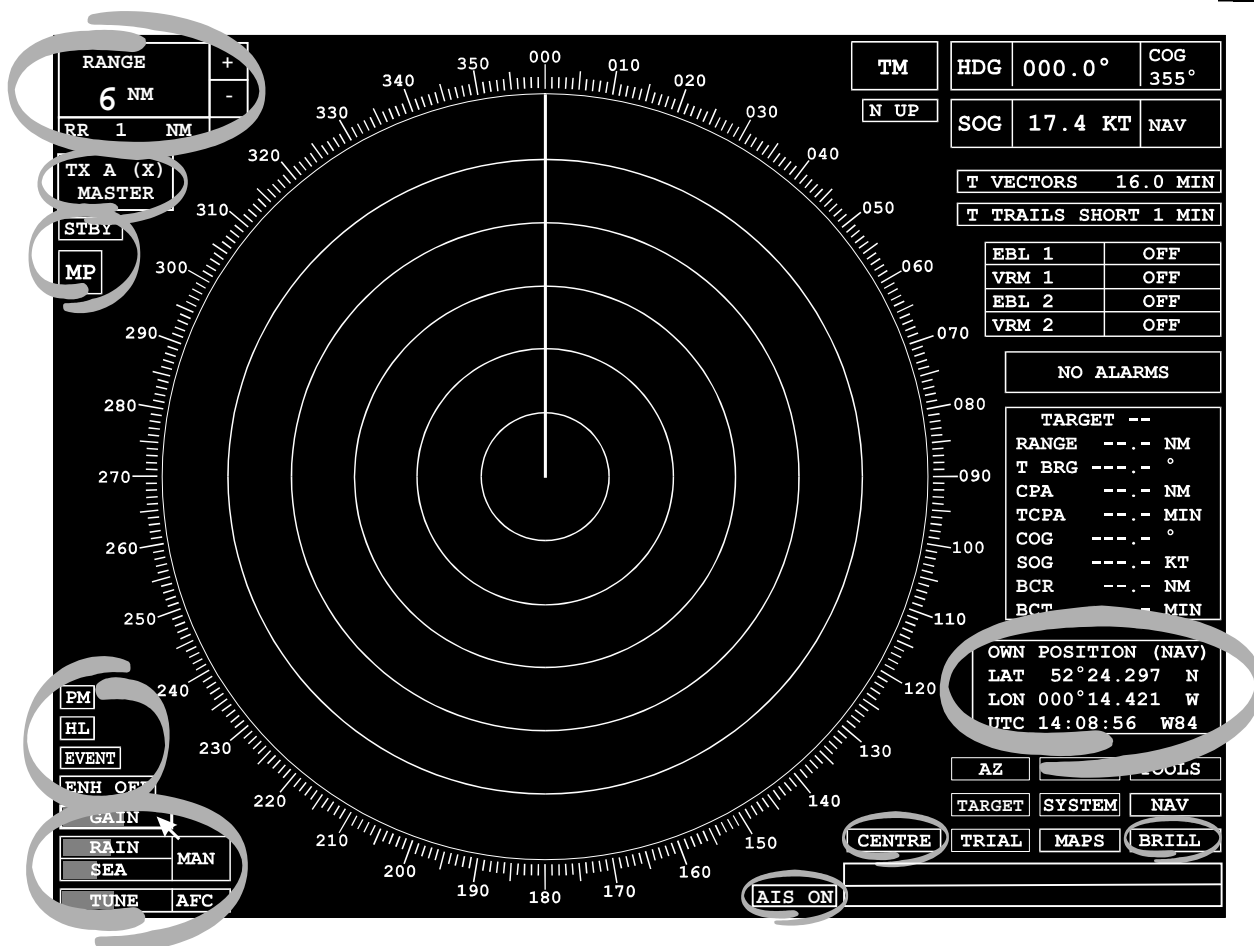

Covered in this chapter:

- A description of transmit mode and returning to standby mode.
- Displaying user specified data on own ship.
- Selecting the radar range and displaying range rings in the video circle.
- Off-centring own ship in the video circle.
- Tuning the transceiver and performance monitoring.
- Using the video processing controls.
- Setting the pulse length of radar transmission.
- Monitoring the radar's performance.
- Recording events.
- Selecting the display's intensity for day or night operation and setting the brilliance.
- Controlling the interswitch.
- Selecting Automatic Identification System (AIS) information display.

Introduction

When TRANSMIT is selected from Standby, the system is switched to transmit. Slave radars can only be set to transmit if the associated Master is already transmitting.

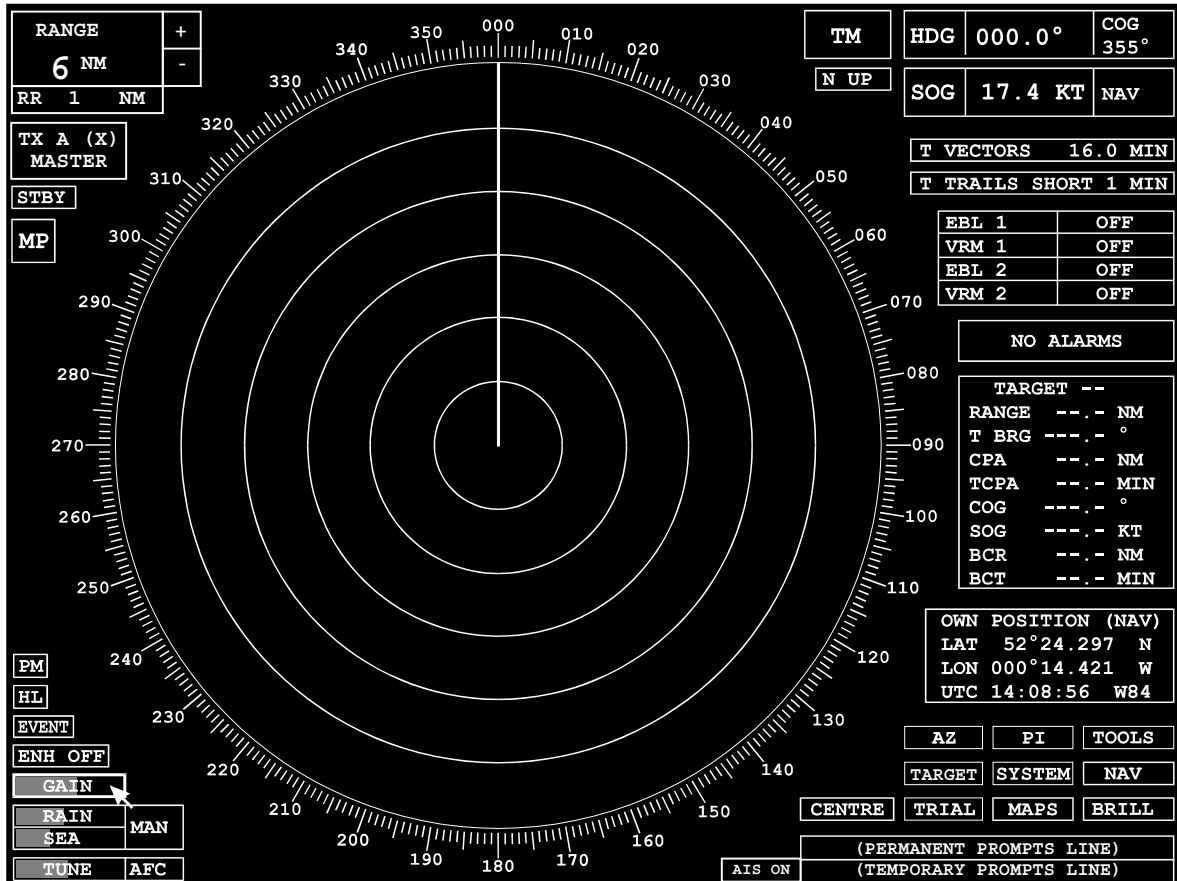

Most of the captions and soft keys associated with the TRANSMIT display are available for selection, and are highlighted individually as the screen cursor moves over them.

Most of the basic radar functions are covered in this chapter. Other, more specific functions are covered in individual chapters.

Returning to Standby Mode

The Standby (STBY) soft key, located at the top left hand side of the display, is used to return the display to Standby mode. See Chapter 2.

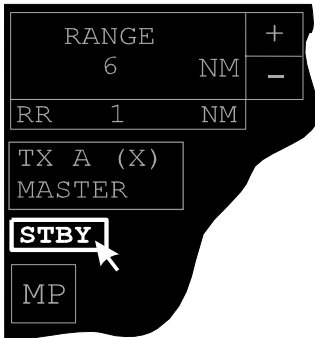

1. Position the screen cursor over the STBY soft key.
2. Left click to reveal the Standby menu.
3. Position the screen cursor over the ACCEPT caption and left click.

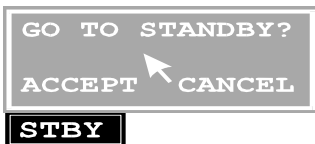

Note – When the menu is displayed, a left click on the *CANCEL* caption, will close the menu and leave the system in TRANSMIT mode.

Transceiver Selection (Optional)

Your display may be configured to operate with one of six transceivers (labelled A to F) located at different positions on the ship. Each transceiver may be either X-Band or S-Band.

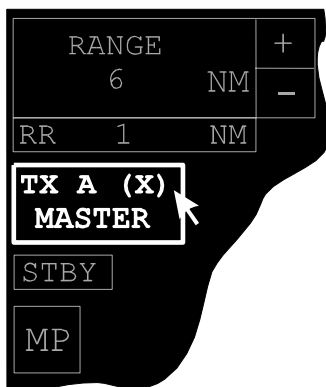

The Transceiver (TX) soft key, in the top left hand corner of the display, gives an indication only of the selected transceiver, its frequency band (S or X) and status (Master or Slave).

If an Interswitch is fitted, a left click on this soft key at any of the displays in the system will reveal a drop down menu containing the current **operational** transceiver/display configuration of the **whole system** with the **user's display** highlighted, see example below.

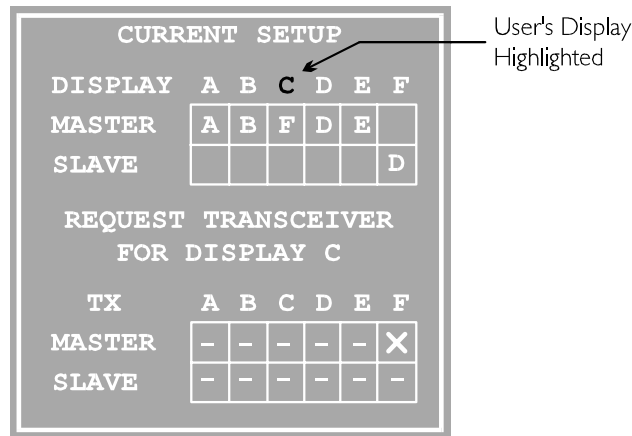

The example above shows the layout for a 6-way 65846 Interswitch. A 2-way 65842 Interswitch would show 2 transceivers and 4 displays.

The 'Request Transceiver. . .' part of the menu, allows the user to select another transceiver for display. A left click in the appropriate dashed box will select the user's display as Master or Slave to that transceiver, and mark the selection with a cross. All fields in the current set up are then updated accordingly.

Note – An invalid selection prompt will appear if slave status is selected for a transceiver that is currently unassigned to a display.

A left click on the transceiver letter will display the position of that transceiver in the prompt line, see examples below.

Note – The transceiver type (X- or S-Band) will only appear if that particular transceiver has been selected for display since switch-on.

X-Band AFT STBD

S-Band FWD

The possible options for transceiver position, as determined from stored turning unit offsets (see Ship's Manual, Chapter 4) are as follows:

'FWD', 'FWD PORT', 'FWD STBD',
'AFT', 'AFT PORT', 'AFT STBD',
'MID', 'MID PORT', 'MID STBD'.

A right click will close the menu.

If a BridgeMaster Interswitch 65642 is fitted, only information for the operator's display is available and a left click will reveal the following drop down menu.

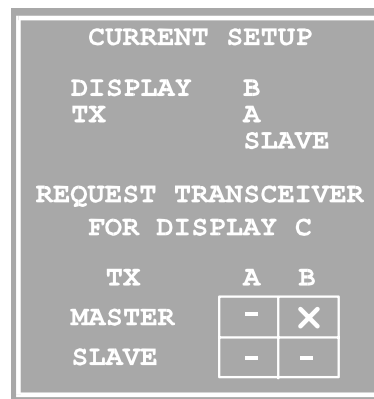

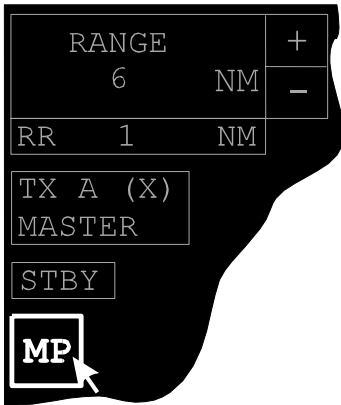

Radar Transmission Pulse Length

The current selection of pulse length is indicated in the 'pulse length' soft key at the left hand side of the display. The caption in the soft key box is an abbreviation of the current pulse length selection, SP (Short Pulse), MP (Medium Pulse) or LP (Long Pulse). The soft key is not displayed in Standby mode, and the pulse length can only be manually changed if the system is configured as a Master.

SP is only available on the 3NM range and below.
MP is available from 0.5NM to 24NM ranges.
LP is available from the 3NM range upwards.

Note – On changing range the system will maintain the current pulse length unless it is not available. There is no automatic reversion of pulse length when reselecting the original ranges.

Selecting the Required Pulse Length

1. Position the screen cursor over the Pulse Length soft key.
2. Left click to cycle to the pulse length required. The caption will cycle in a SP, MP, LP, MP, SP sequence if all three are available. Only pulse lengths that are valid for the selected range can be selected.



Alternatively, a right click on the soft key, will reveal a drop down menu listing the three pulse lengths, with the current selection highlighted. Left click on the length, or right click to close the menu without further action.

An attempt to select an invalid pulse length will result in a warning prompt 'Invalid Range for Pulse Length' being displayed

Range Scales & Range Rings

The radar range scale can be selected from a list of preset values. A set of fixed range rings, displayed as a number of equally spaced concentric circles (normally six), can also be switched ON or OFF. Range scale selection can be made in both Standby and Transmit modes. Range rings cannot be selected or displayed in Standby.



The current range scale and range ring selections are given in the top left hand corner of the display. The ranges are either displayed in nm, km or sm, as selected during initialisation, see Ship's Manual, Chapter 4.

Choosing the Appropriate RANGE Scale

To ensure the best detection of small targets amongst sea clutter, always select the shortest range scale consistent with operational requirements.

Selecting a Range Scale

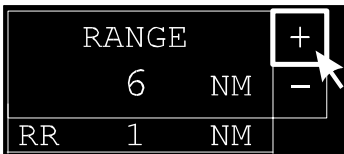

Ranges can be selected by using either the + and – soft keys, or by using a drop down menu.

1. Position the screen cursor over the + (or -) symbol.
2. Left click to select the next (or previous) range scale. Ranges from 0.125 to 96 nm (0.25 to 192 km) are available. An appropriate prompt is displayed when the upper or lower limit is reached.

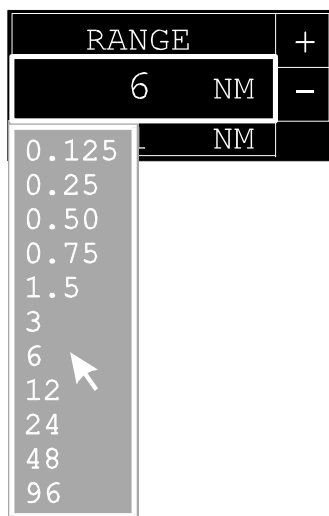

Alternatively a left click on the Range field, will reveal a drop down menu listing the ranges available, with the current selection highlighted. Left click on the range required, or right click to close the menu without further action.

Turning Range Rings ON and OFF

The separation between the range rings (RR) is indicated under the Range field.



To turn the range rings ON or OFF,

1. Position the screen cursor over the Range Ring field.
2. Left click to toggle rings ON or OFF.

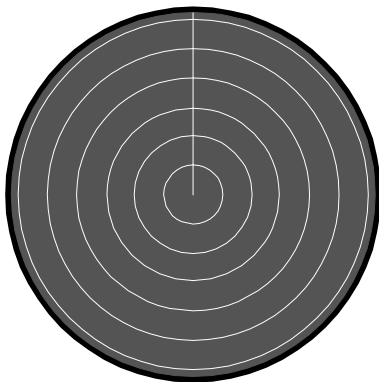

Heading Line (HL)

The ship's heading line is shown as a single line centred on own ship and drawn to the edge of the video circle. In the Head-up presentation mode (see Chapter 5) the line is always drawn at 000.0°.

When own ship is off-centred, an additional indication of own ship's heading is shown by an asterisk and a short line drawn just inside the video circle.

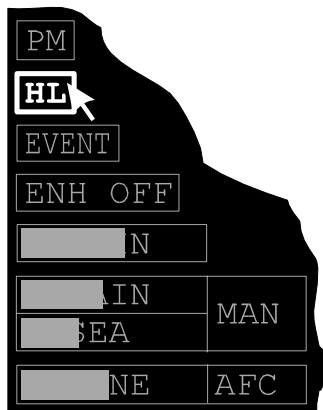
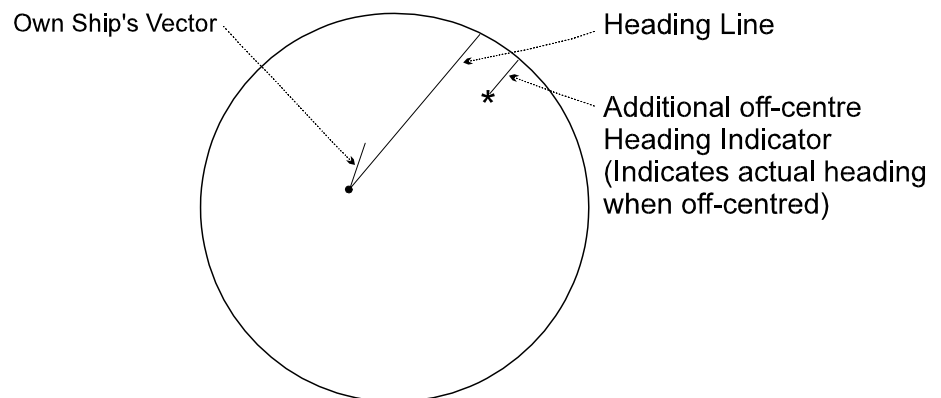

Stern Line (SL)

During initialisation, the heading line can be configured as a Stern Line drawn behind own ship, see Ship's Manual, Chapter 4. The type of line displayed is indicated by whether HL or SL is written in the soft key at the left side of the display, see example left. This function cannot be changed from the TRANSMIT display. However, the line can be turned on/off as described below.

Temporarily Hiding the Heading/Stern Line

The heading/stern line can be removed temporarily, to view more clearly something which is on, or close to, the line.

1. Position the screen cursor over the HL (or SL) soft key.
2. Press and hold down the left key.
The line, together with all of the synthetics within the video circle, remains hidden as long as the key is held down.
3. Release the key to return the line and synthetics to the video circle.

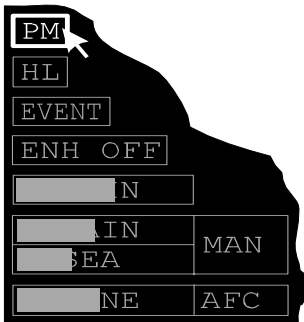

Performance Monitoring

The Performance Monitoring facility is only available if the display is a Master display connected to a transceiver fitted with performance monitoring equipment. See Ship's Manual, Chapter 4. The facility is not available in Standby mode. Also the PM soft key cannot be selected when in any EDIT mode.

Note – Selecting *PERF MONITOR* from the System menu is for setting up the Performance Monitor only. Refer to Ship's Manual for further details.

Two modes are provided, a SYSTEM Mode which monitors the performance of the overall system, and an RX Mode which monitors the receiver path for incoming signals, including the receiver located in the Transceiver unit.

Access to the monitor facility is provided by the Performance Monitor (PM) soft key located at the left hand side of the display. Anti-clutter processing should be set to MAN when performance monitoring, and the anti-clutter controls (RAIN and SEA) set to minimum. The transceiver should also be set to Long Pulse operation

Viewing the Performance Monitor

1. Position the screen cursor over the PM soft key.
2. Left click to reveal the Performance Monitor drop down menu.
 - A further right click will close the menu without further action.
3. Position the screen cursor over the MODE caption in the menu.
4. Left click to toggle the mode for SYSTEM or RX.
5. Left click and drag the TUNE control bar for optimum display of arcs on the radar display.
6. Repeat steps 3, 4 and 5 selecting alternate mode in step 4.

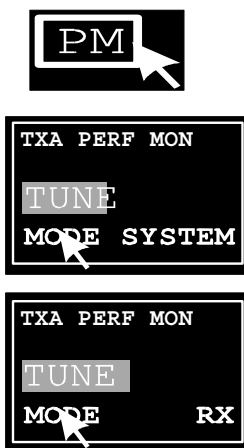

Note – When the PM drop down menu is displayed, up to four arcs are shown on the radar screen. These arcs are approximately 0.3 nm, apart and start at 8 nm. The arcs extend from 290° to 320° (S-Band), or 155° to 185° (X-Band), with respect to the heading line. The arcs are

spaced at 5dB intervals and, for example, if performance decreases below the second arc, this shows a 10dB drop in performance.

The level of PM tuning voltage is indicated by the control bar above the MODE SYSTEM or MODE RX caption in the PM menu. This bar indicates the tuning level in percentage terms with 0% on the left, 100% on the right.

If for a period of 10 seconds, neither key (left or right) is pressed or the screen cursor is not moved, then the PM drop down menu is removed from display automatically.

Warning Prompt

If sector blanking is active, the warning prompt shown below is displayed continually while the Performance Monitor drop down menu is displayed.



Sector blanking inhibited



Events (ATA and ARPA only)

The EVENT soft key is only active if history tracks (own ship/targets) are being recorded.

For more information on Events, refer to Event Recording under Track History in Chapter nine.

A left click on the EVENT soft key records the lat/long position of own ship and each selected track. Current time is also recorded. If the tracks are currently being displayed, the event will be shown in the video circle.



Video Processing Controls

The video processing controls are located in the bottom left hand corner of the display.

Video Gain and Anti-Clutter Controls

The video GAIN control, and the anti-clutter (RAIN & SEA) controls when set to Manual (MAN), can be adjusted independently. Each control is adjusted using the shaded bar behind its associated caption which indicates the level in percentage terms with 0% on the left, 100% on the right.

Using the Video GAIN Control

Always adjust the GAIN setting while on the longer range scales of 12 or 24 nm. (24 to 48 km). A light background speckle **should** be present to achieve the best target detection and long range performance. A **temporary** reduction in gain can be beneficial when searching for targets in rain or snow conditions. Video gain is independently adjustable for AUTO and MAN anti-clutter modes.

Using the Manual Anti-Clutter SEA Control

Use the Anti-Clutter SEA control to reduce sea clutter to an operational level where some residual clutter speckle is present. The setting must permit small targets, often of similar signal strength to the sea clutter returns, to be detected.

Always use the control with great care. Avoid setting the control to completely remove all sea clutter, as this will reduce the detection of small targets. The setting should be periodically checked as prevailing sea conditions change.

Using the Manual Anti-Clutter RAIN Control

Use the Anti-Clutter RAIN control to optimise suppression of rain clutter, i.e. balance the detection of targets within the clutter region (under the rain) with detection of those outside the clutter region.

Always use the control with great care. Excessive suppression can cause loss of small targets. It is often advantageous to use this control to search for targets in the clutter region, returning the control to zero after the search.

Using the Automatic Anti-Clutter (or VISION) Control

In open sea conditions, use AUTO to suppress rain and sea clutter. This normally provides optimum detection by adapting the amount of clutter suppression applied to the varying characteristics of clutter returns.

Pulses received from radar transponders are subject to slight degradation. However, they are still easily recognisable by their signal strength.



Selecting Manual or Automatic Anti-Clutter Control

1. Position the screen cursor over the MAN/AUTO selection field.
2. Left click to toggle control between MAN (manual) or AUTO (automatic)/VISION. The system will use VISION if the display is VISION equipped.
3. If VISION equipped a right click will produce a drop down menu of MAN, AUTO and VISION. Then left click on the mode required to select.



Manual Change of GAIN, RAIN & SEA Settings

1. Position the screen cursor over the control you wish to change.
2. Left click to make control bar active. The bar will appear yellow.
3. Move the cursor control left or right to move the bar to the level required.
4. Left click to set the level and de-activate the bar. The bar will return to its dimmed shaded state.

Note – Rain and Sea settings cannot be changed in AUTO mode.

IMPORTANT NOTE – There are different stored values of GAIN setting for AUTO, MANUAL and VISION (if fitted), you need different settings for each mode.

Enhanced Video Mode

A substantial improvement in the presentation of small and/or short range targets, especially when operating at range scales of 3 nm (6 km) and above, can normally be achieved by selecting the enhanced video mode. This facility is available on range scales 0.75 nm and above. Targets are not enhanced close to own ship.

Using the Enhanced Video Mode

In estuary and open sea conditions, always use the enhanced video mode for best target detection. This will enhance small targets, significantly improving their perceptibility on the display at all ranges, especially on range scales of 3 nm (6 km) and above.

WARNING - USE THE ENHANCE CONTROL WITH CAUTION. IF USED ON SHORT RANGE SCALES IT WILL DEGRADE TARGET DISCRIMINATION.

Turning Enhanced Video Control ON and OFF



1. Position the screen cursor over the Enhance (ENH) soft key.
2. Left click to toggle the Enhance control ON or OFF.



Transceiver Fine Tuning

The transceiver tuning indicator is located in the bottom left hand corner of the display. The current level of tuning is indicated by the shaded bar behind the TUNE caption and is continuously updated. This bar indicates the level in percentage terms with 0% on the left, 100% on the right. The tuning indicator is only displayed when the radar is in Transmit mode, and can only be adjusted manually if the system is configured as a Master radar. Coarse tuning is set up from the System menu during initialisation.

Selecting Manual or Automatic Tuning

Only applicable for Master radars. The system defaults to the mode of tuning last selected (MAN or AFC).



1. Position the screen cursor over the AFC/MAN selection field.
2. Left click to toggle the tuning control to MAN (Manual) or AFC (Automatic Frequency Control).

Manual Fine Tuning Adjustment

Only applicable for Master radars. Long pulse must be selected, ideally using the highest range scale that shows a known target near to the edge of the radar circle. The tuning mode should be set to Manual (MAN).



1. Position the screen cursor over the TUNE caption.
2. Left click to activate the control. The lower of the two yellow bars is the tuning indicator. The upper bar is the tuning control level.
3. Move the cursor control left or right to adjust the tuning control (upper bar) until the maximum level is reached on the tuning indicator (lower bar). If distant radar targets are visible, use these for the final adjustment.
4. Left click to set the level and de-activate the bar. The bar will return to its grey state. A right click will de-activate the bar but not set the level.

Note – For accurate tuning to be achievable, coarse tuning must have been correctly adjusted during radar initialization. Refer to Ship's manual for details.

User Specified Data

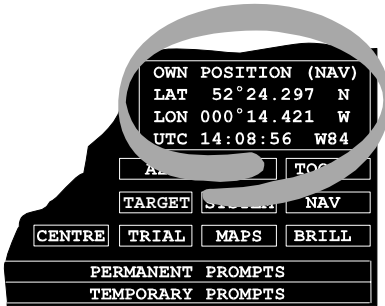

The user data area of the display is located at the bottom right hand side, above the help area and function soft keys. The area is used to show information relating to own ship and is available in both Standby and Transmit modes.

The following types of data can be displayed,

- Own Ship's Position
- Waypoint Data
- Wind and Depth

Note – Waypoint and 'Wind and Depth' data are only available if the appropriate sensor inputs were selected during initialisation. See Ship's Manual, Chapter 4.

Selecting the Data Type

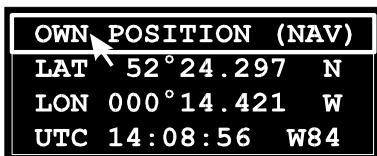

1. Position the screen cursor over the top line of text in the User Data box.
2. Left click to select the type of data required. Each click will cycle the display to the next type. Alternatively a right click will reveal a drop down menu containing a list of data types, left click on the type required, or right click to close the menu without further action.



Data Displays

An example of each type of data display is given below. When specific data is unavailable, the associated readout is replaced with dashes.

Own Ship's Position

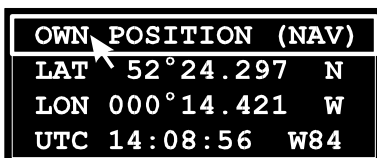

The 'source' display, in brackets after the title, depends on the external positioning input configured during initialisation (see Ship's Manual, Chapter 4) and/or the position mode selected (see Chapter 9).

The source can be any one of the following: (DGPS), (GPS), (DEC), (LOR), (DR) or (EP). (NAV) is shown if an unknown navigational input is being used.

Note that the position displayed here is the position of the centre of the ship. Any waypoint data given on the display

will be related to this point. This position will differ slightly from that shown on the navigation sensor's own internal display, given that the correct sensor offsets have been entered into the Radar Display during initialisation, unless the navigation sensor's antenna is actually sited at the centre of the ship. The co-ordinates of the navigation sensor's antenna relative to the centre of the ship, if entered during initialisation, enable the true position of Own Ship's Centre to be displayed.

Time and Datum

The time information can be displayed as UTC directly (UTC), UTC with an offset (LOC) or local time (LOC) if there is no UTC input set in initialisation. This is set up in the Navigation function, see Chapter 9.

The datum used for all displayed Navigation data is WGS84, and W84 is always shown in the menu.

Alarms

The LAT/LONG information will be displayed in red if there is an alarm which affects the validity of the data (ie Compass, Log or Nav Input).

When there is a position alarm the LAT/LONG information will be dashed out.

The TIME information will be dashed out after 30 seconds if the data becomes invalid.

Invalid Latitude

If own ship's latitude is greater than 78°N or 78°S, then own ship's lat/lon position will be display in **RED** and all map data and route information will be removed from the screen.

A permanent prompt Invalid latitude will also be displayed.

Invalid latitude

Waypoint Data

WAYPOINT DATA	
WPT	-----
XTE (L)	nn.nn NM
DTG	nnn.nn NM
TTG nn:nn T BRG	nnn.n°

The information displayed in this menu is dependent on the route set up configured within the Navigation function, see Chapter 9.

The EPA(L) menu has a slightly different layout but contains the same data.

When information is displayed, it relates to the next waypoint in the current route as follows:

- WPT The number of the NEXT waypoint in the current route.
- T BRG True Bearing of waypoint from own ship.
- DTG Distance To Go to waypoint (in nm or km).
- XTE(L) Cross Track Error (**L**eft or **R**ight) (in nm, km or sm).
- TTG Time-to-go to waypoint (in hh.mm).

Wind and Depth

WIND AND DEPTH	
REL WIND	nnn KT
	nnn ° REL
DEPTH	nnnn M

This 'menu' is only available if either or both inputs are configured during initialisation. See Ship's Manual, Chapter 4. Either TRUE or REL (Relative) wind speed data is displayed as received from the sensor. Depth data is always displayed in metres.

Off-centring the Picture

The default picture is with own ship placed at the centre of the video circle. However, the picture can be off-centred by 'dragging' the origin of the heading/stern line to a new position within the video circle as follows.

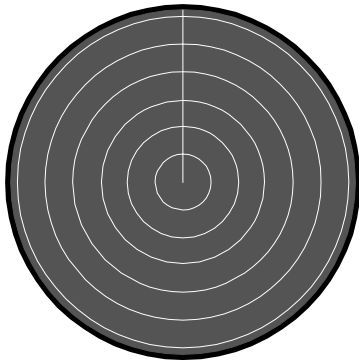

The video display can be off-centred by up to two thirds of the range scale radius.

1. Position the video cursor over own ship's position.
2. Press and hold down the left key.
3. Drag own ship to the required off-centred position.
4. Release the key.

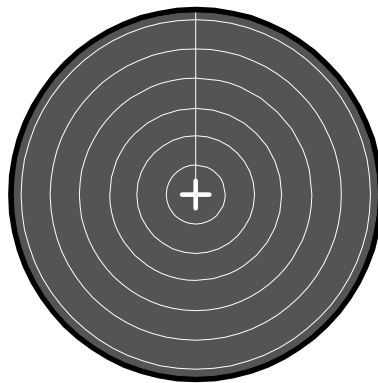

Position cursor
over 'Own Ship'

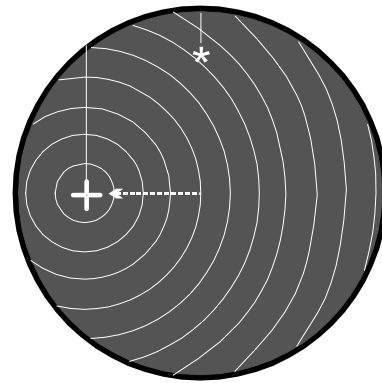

Left key press and
drag to new position

Centring the Video Display

The CENTRE soft key, located near the bottom right hand corner, can be used to redraw the display with own ship at the centre of the video circle, or to reposition own ship for maximum view along own ship's course.



To Centre the Display

1. Position the screen cursor over the CENTRE soft key.
2. Left click to place own ship at the centre of the video circle.



For Maximum View



1. Position the screen cursor over the CENTRE soft key.
2. Right click to reveal a pop up menu containing the 'Max View' option, see example left.
3. Left click to select Max View, or right click to close the menu without further action.

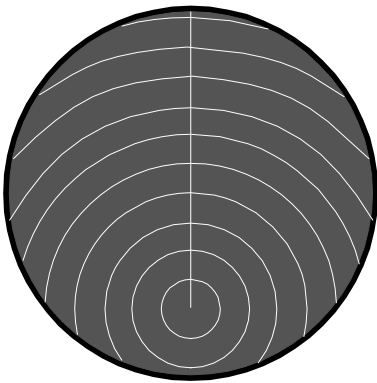

When Max View is selected, the video display is off-centred by two thirds of the range scale radius in a direction determined by the operating mode.

In unstabilised mode (H up), the direction is reciprocal to the heading marker.

In stabilised mode, the direction is reciprocal to the course over ground (COG), or heading marker if COG is unavailable.

Automatic Identification System (AIS) information display

This function is only available on ATA's and ARPA's. Additionally it requires the AIS option hardware to be fitted and one of the serial input (3, 4 or 5) to be set to receive an AIS input.

When set up the system will display AIS information on the screen and in the tote. See Chapter 7 for more information.

Turning AIS feature ON and OFF



1. Position the screen cursor over the AIS ON caption box.
2. Left click to display a warning message.
3. Left click on YES in the dialog box to toggle AIS ON or OFF.

The caption will indicate the actual state of the AIS feature.

The grey shaded area in the background of this box indicates the number of AIS targets displayed. A full box indicates 40.

Brilliance Control

The BRILL soft key, located in the bottom right hand corner of the display, is used to select day or night brilliance and to set the level of display intensity for different components of the display.



Note – The display monitor has its own associated brilliance control which you may need to adjust.



A right click on the BRILL soft key will reveal a drop down menu listing the DAY/NIGHT brilliance options available (1 day-time level and 3 night-time levels). Left click on the setting required. See example left. To set the display intensity for different components of the display proceed as follows.

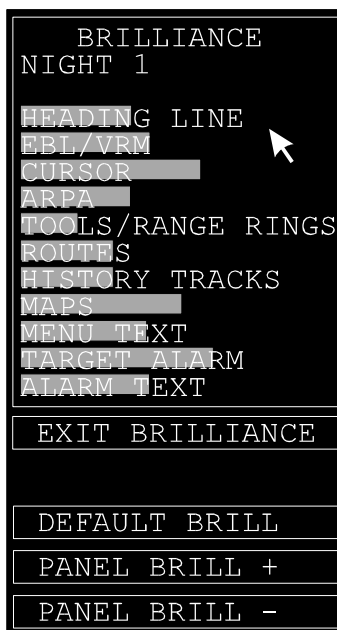

1. Position the screen cursor over the BRILL soft key.
2. Left click to reveal the BRILLIANCE menu.
See example left.

The menu lists the various components of the display for which the brilliance can be set independently.

The first line of the menu, under the heading, indicates the DAY/NIGHT brilliance option to which the menu settings apply.

The settings are independently stored for each DAY/NIGHT brilliance option, and are retained on switch-off.

Note – If the brilliance controls are not providing adequate control of the display, the monitor may need adjusting (see *Monitor Testing in Ship's Manual, Chapter 5*).

Day/Night Selection

One of four different pre-set levels of display intensity can be selected (one day-time level and three night-time levels).



1. Position the screen cursor over the first line in the menu (Night 1 in the example left).
2. Left click to cycle through the settings available. The display intensity will change with each click in a sequence of NIGHT 1, NIGHT 2, NIGHT 3, NIGHT 1.

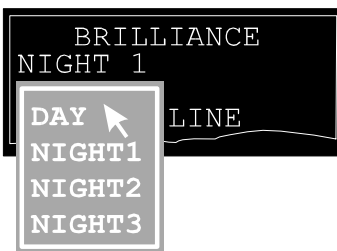

Alternatively, a right click will reveal a drop down menu listing the settings available. Left click on the setting required. See example left.

Note – This method of selection is normally used to switch between night-time settings; the day-time setting can only be selected from the drop down menu.

Changing the Relative Brilliance Settings



1. Within the menu, position the screen cursor over the item you wish to change.
2. Left click to make the control bar active. The bar will appear yellow.
3. Move the cursor control left or right to move the bar to the level required.
4. Left click to de-activate the bar. The bar will return to its dimmed shaded state.

Note – The Heading Line, Target Alarm and Alarm Text lines have a higher minimum preset level to prevent them being turned off completely.

Returning to the Default Brilliance Settings

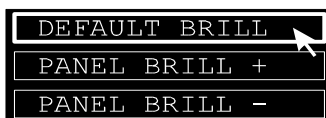

1. Position the screen cursor on the DEFAULT BRILLIANCE soft key.
2. Left click to return to the default (ie factory set) relative brilliance levels for the current brilliance option (eg Night 1 only).

Panel Brilliance

The lighting brilliance of the Radar control Panel is controlled by the PANEL BRILL (+ and -) soft keys.

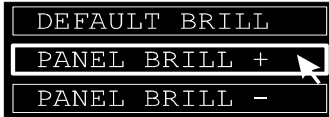

1. Left click on the PANEL BRILL + soft key to INCREASE the brilliance (or click and hold).
2. Left click on the PANEL BRILL – soft key to DECREASE the brilliance (or click and hold).



Note – *If a dedicated control panel is fitted (see Chapters 1 and 2), the PANEL BRILL soft keys do NOT appear below the brilliance menu. In this case, panel brilliance is controlled from the dedicated control panel.*

Exiting the Brilliance Menu



1. Position the screen cursor over the EXIT BRILLIANCE soft key located directly under the menu.
2. Left click to exit.

CHAPTER 4

Ship's Heading and Speed

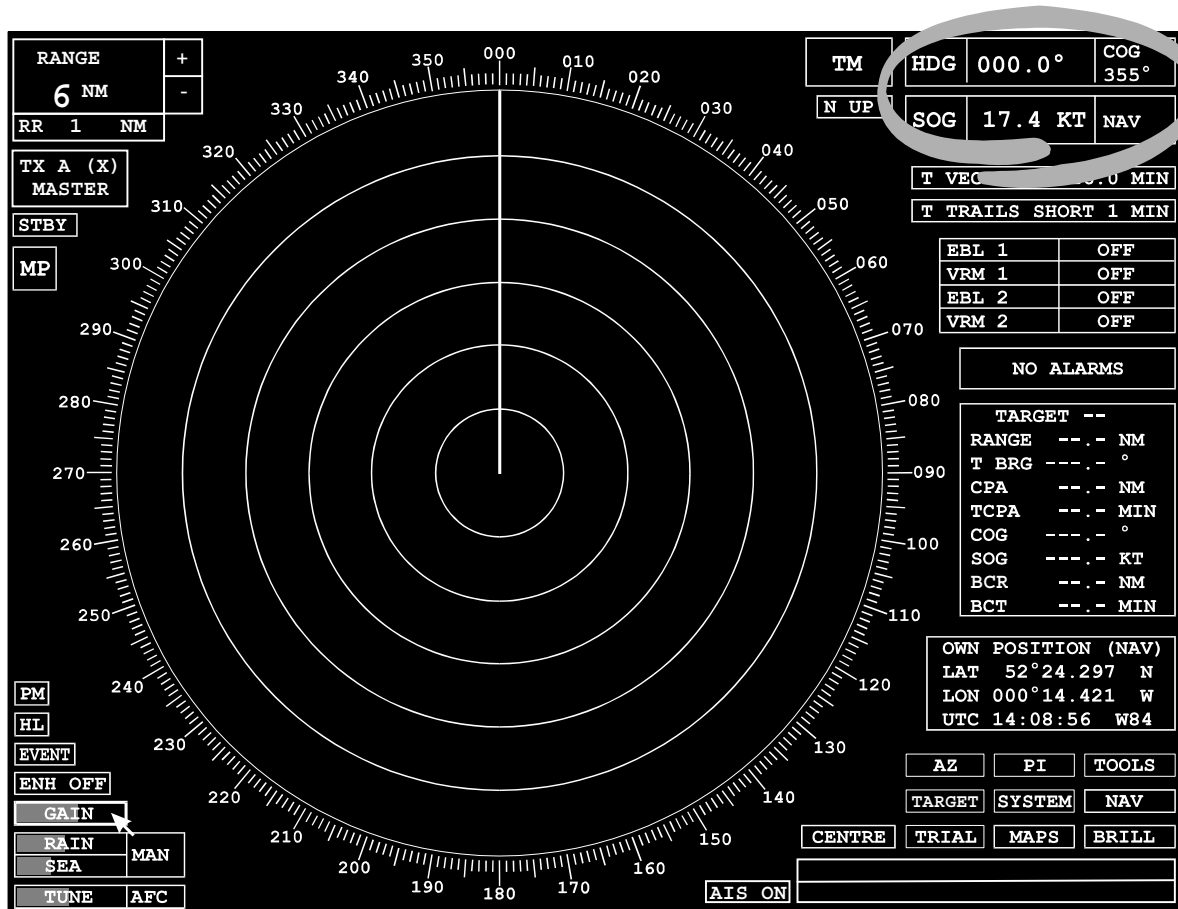

Covered in this chapter:

- The information shown in the heading display.
- The information shown in the speed display.
- Selecting a speed mode.

HDG	000.0°	COG 355°
SOG	17.4 KT	NAV

Introduction

Ship's **Heading** and **Speed** are displayed in the top right corner of the display and are available in both Standby and Transmit modes.

Heading Display

The heading display is divided into three fields.

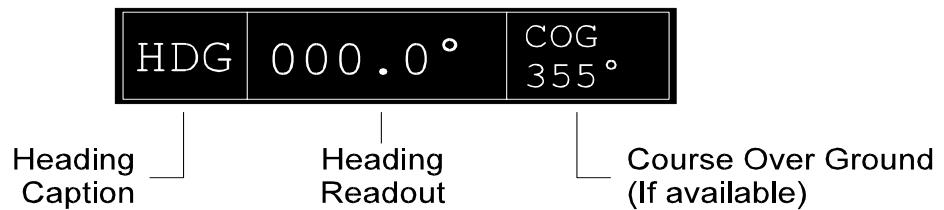

***Note** - The Heading Caption and Heading Readout fields are only selectable with certain compass types. They are never selectable when in any EDIT mode.*

Heading Caption



The heading caption is always 'HDG'.

Heading Readout



A readout of true heading is always displayed, unless compass alignment is being prompted, or a compass error has occurred.

Compass Errors

A compass error will cause the heading readout to change from green to red and a compass alarm will be raised. If a stabilised picture presentation is in use, and the error is still present, then after 1 minute, the picture will revert to Head-UP.

Compass Alignment

For certain types of compass input, it will be necessary to align the heading readout by manually entering the current heading after the radar display is switched-on. The need for alignment is indicated by the heading readout flashing green.

To Align the Compass



1. Position the screen cursor over the heading readout.
2. Left click to access. Heading is displayed in yellow.
3. Move the cursor control left or right to change the heading.
The heading should be the ship's head derived from another source.
4. Left click to accept the new heading.

Alternatively a right click will reveal a drop down keypad from where the heading can be entered, refer to Chapter 15. If the compass is being re-aligned, a dialogue box is displayed at step 2 – left click on Accept to proceed.

Course Over Ground



If **SOG** (Speed Over the Ground) is selected in the speed display, this shows COG (Course Over the Ground). If the speed is less than 1 KT, the course is shown as dashes.

If **STW** (Speed Through the Water) is selected in the speed display, the field is empty.

Magnetic Headings

If a magnetic compass is fitted and a serial '\$--HDT' message type was selected during initialisation, a true heading will be displayed.

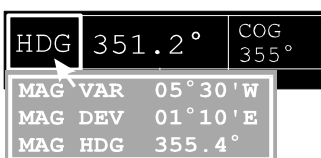

If a magnetic compass is fitted and a serial '\$--HDG' message type was selected during initialisation, a left click on the heading caption will reveal a drop down menu containing the magnetic variation, deviation and heading. All data display in this menu is being provided by the compass and cannot be changed. A further click will close the menu.

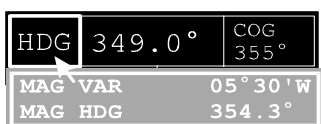

If a magnetic compass is fitted and a serial '\$--HDM' message type was selected during initialisation, a left click will reveal a drop down menu containing the magnetic variation and heading. The variation must be entered manually as follows.

Entering a Manual Variation

1. Position the screen cursor over the MAG VAR line.
2. Left click to reveal a drop down numeric keypad from where the magnetic variation can be entered. Refer to Chapter 15 for further information on numeric keypads.

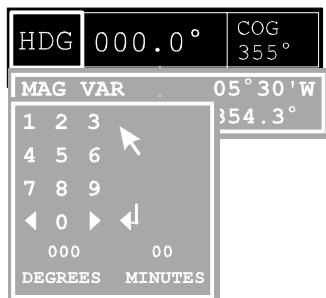

Speed Display

This shows **own ship's speed** and is divided into three fields.



Speed Caption | Speed Readout | Speed Mode

Note – These three fields cannot be selected when in any EDIT mode.

Speed Caption

The speed caption is, **STW** (Speed Through Water) when the selected speed is 'water locked', or **SOG** (Speed Over the Ground) if the speed is 'ground locked'.



Note – The caption is also **SOG** if a water speed has been selected and manual **drift** is being applied. See **Applying Drift**.

The Speed Caption field is only active when the ECHO REF speed mode is selected. See **ECHO REFERENCE Speed Mode**.

Speed Readout

This can only be changed by the user when Manual speed mode is selected. See **MANUAL Speed Mode**.



Speed Mode

An abbreviation of the selected Speed Mode is displayed in this field.



Speed Mode Options

A left click on the speed mode will reveal a drop down menu containing a list of speed modes. The external speed sources available to the user are determined during initialisation, see Ship's Manual, Chapter 4. Refer to table on next page.

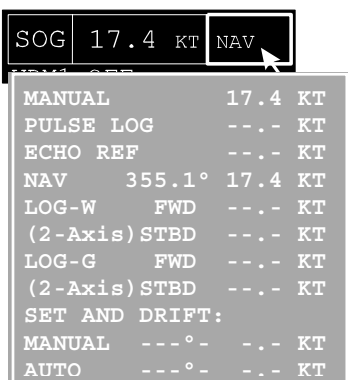

Notes – If no data exists, dashes or 0.0 are displayed. The data field of a menu option is displayed in red if that particular speed source is not valid. ECHO REF is not displayed if the radar is configured as an Electronic Plotting Aid, and is not highlighted when in standby.

MANUAL	17.4	KT
PULSE LOG	---	KT
ECHO REF	---	KT
NAV 355.1°	17.4	KT
LOG-W FWD	---	KT
(2-Axis) STBD	---	KT
LOG-G FWD	---	KT
(2-Axis) STBD	---	KT
SET AND DRIFT:		
MANUAL	---	KT
AUTO	---	KT

Selecting a Speed Mode

1. Within the menu, position the screen cursor over the required mode.
2. Left click to select.

The table below gives a brief description of the various speed modes.

SPEED MODE	SPEED CAPTION	BRIEF DESCRIPTION
Manual	STW	Allows you to enter a speed, normally in circumstances where no speed data can be received from other external devices. The acceptable input range is from 0 to 75kts. See 'Manual Speed Mode'
ECHO Ref	SOG	Any tracked target can be selected as an echo reference. Once selected, its velocity is assumed to be zero and own ship's speed is calculated on this assumption. The selected target is marked with an 'R' symbol in the video circle. See 'Echo Reference Mode'
Pulse Log	STW	Speed is derived from a Pulsed Log. A Log Error alarm is raised if the input fails or the indicated speed is in excess of 75kts.
Navigation Sensor	SOG	Speed is derived from a Navigation Sensor. A Nav Speed alarm is raised if the input fails.
Serial Log Ground Locked (LOG-G)	SOG	Speed is derived from a Serial Log. Where the log is dual axis the fore/aft and port/starboard components of both ground and water data are displayed in the speed menu. The resultant velocity is displayed in the main speed readout for ground locked LOG, and the fore/aft component is only displayed for water locked LOG. A Log Error alarm is raised if the input fails.
Serial Log Water Locked (LOG-W)	STW	

MANUAL & ECHO REF speeds cannot be used as the speed mode if the AIS feature is turned on.

If selection is attempted a warning prompt is displayed as below.

Not available when AIS is on

Note – From Version 5.0 software the speed mode in use is now stored internally at switch off.

MANUAL Speed Mode

When MANUAL speed mode is selected the speed can be set as follows.



1. Position the screen cursor over the speed readout.
2. Left click to access. Speed is displayed in yellow.
3. Move the cursor control left or right to change the speed.
4. Left click to accept the new speed.

Alternatively a right click will reveal a drop down keypad from which the speed can be entered, refer to Chapter 15.

ECHO REFERENCE Speed Mode (ATA & ARPA only)

Selecting the ECHO REF mode forces the screen cursor to the centre of the video circle.

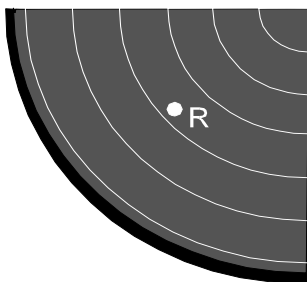

Selecting a Target as the Echo Reference

1. Position the cursor over an established target.
2. Left click to select that target as the echo reference. 'R' is displayed adjacent to the reference target and the target has its true vector removed and its speed is set to zero.

A prompt is displayed if no target is found.

Selecting a New Target as the Echo Reference



1. Left click on Speed Caption to force screen cursor to centre of circle as before.
2. Select a new target using the procedure above.

Manual Set and Drift

A Set angle and Drift rate, can be applied manually in all water referenced speed modes. If the AIS feature is turned on then Manual Set and Drift cannot be used.

MANUAL	17.4	KT		
PULSE LOG	--.	KT		
ECHO REF	--.	KT		
NAV	355.1°	17.4 KT		
LOG-W	FWD	--.	KT	
(2-Axis) STBD	--.	KT		
LOG-G	FWD	--.	KT	
(2-Axis) STBD	--.	KT		
SET AND DRIFT:				
MANUAL	---	°	--.	KT
AUTO	---	°	--.	KT

From within the drop down menu,

1. Position the screen cursor over the MANUAL SET and DRIFT line.
2. A left click will reveal a drop down numeric keypad allowing manual entry of the SET and DRIFT value. This keypad includes a 'CANCEL' option to allow values to be replaced with dashes if the function is not required.



Drift Applied to Water Speeds

If a water speed has been selected, and a Set and Drift rate have been entered, drift is applied to generate a ground speed and the speed caption changes to SOG. The word 'DRIFT' is also displayed in orange under the mode abbreviation in the Speed Mode field.

Any previous values of Set or Drift are automatically cleared on selecting a ground locked log speed, but it is possible to enter new values prior to selecting a water mode.

Note – *If the selected speed input is a dual-axis water-locked log, the SOG is determined using the SET & DRIFT which are calculated from both fore/aft and port/starboard components of the log input.*

Auto Set and Drift (AIS option only)

If an AIS option is fitted and on, and a water referenced log is being used then the AUTO line will show the automatically calculated Set and Drift.

This calculation is the difference between the water referenced log and the ground referenced Nav Speed.

It is used to produce water reference velocities for the AIS targets

An **AUTOTIDE** alarm will be raised if the NAV speed is not valid, when a water referenced speed is being used.

Presentation, Motion, Vector & Trail Modes

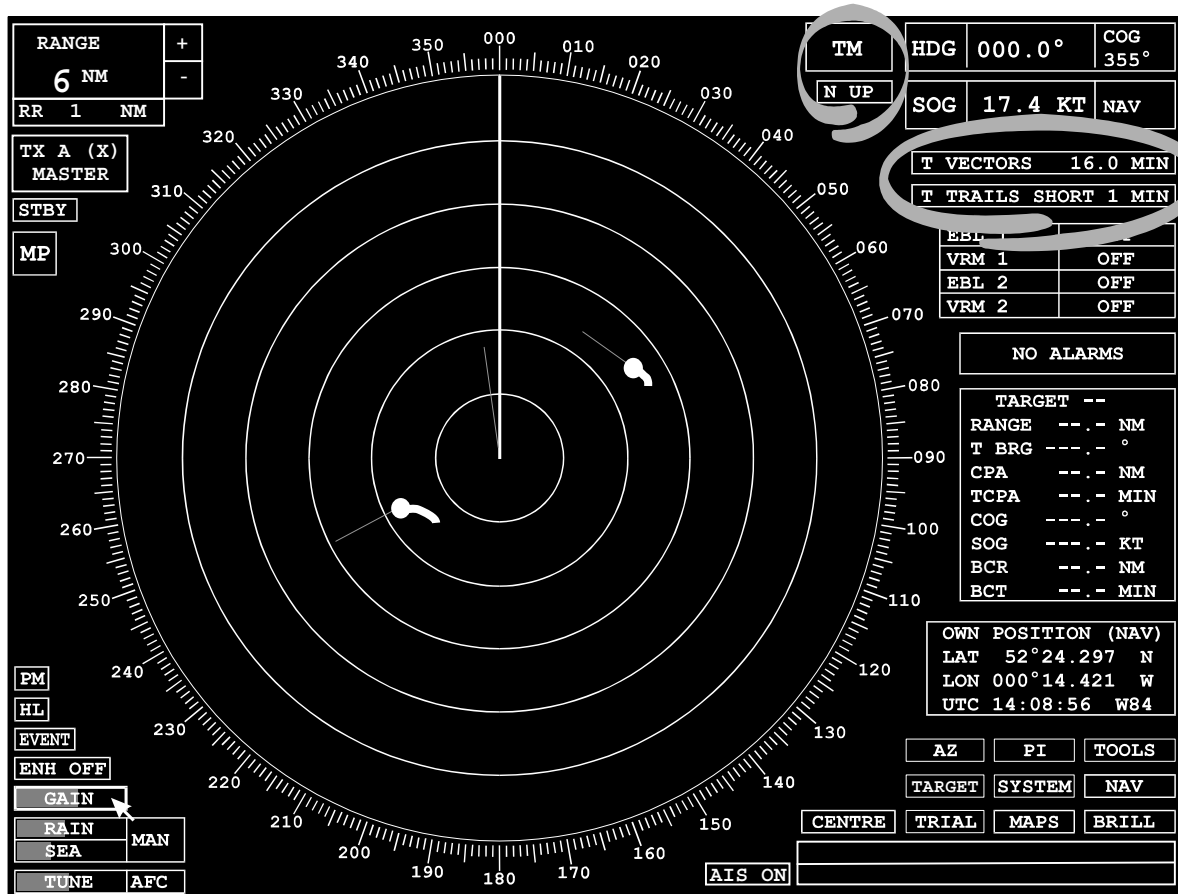

Covered in this chapter:

- Selecting a presentation mode and how this affects the video display.
- Selecting a motion mode and how this affects the display of own ship and other targets on the video display.
- Displaying the velocity of own ship and other targets as vectors on the video display.
- Displaying the history of a target's movements as a trail on the video display.

Introduction



The **Motion Mode** and **Presentation Mode** selection fields are located in the top right corner of the display, immediately to the left of the Heading and Speed displays, and are available in both Standby and Transmit modes.



The **Vector Mode** and **Trail Mode** selection fields, located beneath the Heading and Speed displays, are only available in Transmit mode.

Presentation Modes

Data from the compass can be processed to produce a correct 'stabilised' display. There are two types of stabilised display available, **North-Up** and **Course-Up**. Without a compass input, the display is 'unstabilised' and is shown with the ship's heading marker vertically upwards indicating straight ahead movement (**Head-Up** mode).

Head-Up

Unstabilised display – the ship's heading marker is always shown vertically upwards indicating straight ahead movement.

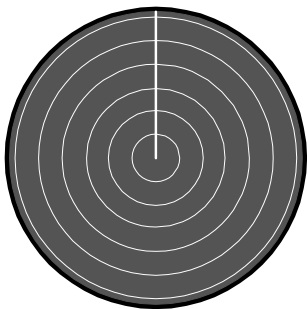

000

North-Up

Stabilised display – The bearing scale shows 000° at the top of the video circle (assumed to be true north). The ship's heading marker is shown at the appropriate bearing.

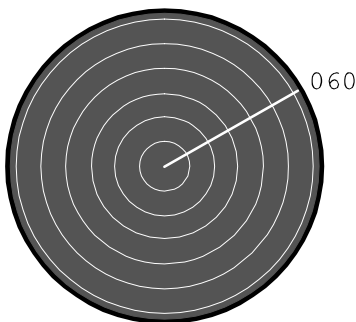

060

Course-Up

Stabilised display – On selection of Course-Up mode, the ship's bearing is shown at the top of the video circle with 000° elsewhere on the circle, still representing true north.

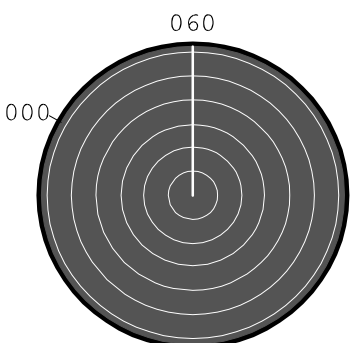

060

000



The currently selected Presentation Mode is displayed.
The modes available for selection are,

- **H UP** Head-Up
- **N UP** North-Up
- **C UP** Course Up

Selecting a Presentation Mode

A stabilized presentation mode cannot be selected if the compass is on alarm or has not been initialised.

Either

1. Position the screen cursor over the Presentation Mode field.
2. Left click consecutively to toggle through the available options.

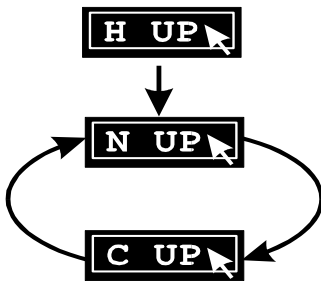

Note – If H UP is the currently selected mode, the first left click will select the N UP mode. Subsequent left clicks will then toggle between the C UP and N UP options only. This prevents the accidental selection of an unstabilised mode while in a stabilised mode. To select the H UP mode use the method described below.

OR

1. Position the screen cursor over the Presentation Mode field.
2. Right click to reveal a drop down menu.
3. Position the screen cursor over the required mode.
4. Left click to select.

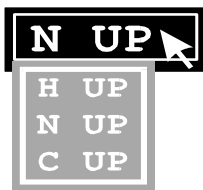

Course-UP Reset

When the **C UP** mode is in operation, if the ship alters course, a Course-Up reset should be performed by reselecting the mode. This realigns the bearing scale to bring the new course to the top of the video circle, ie it doesn't happen automatically as the ship changes course.

Motion Modes

The motion mode determines whether own ship moves across the radar picture or remains at a selected point, and how the trails of moving targets are displayed.



The currently selected Motion Mode is displayed. The modes available for selection are:

- **RM(R)** Relative Motion – Relative Trails
- **RM(T)** Relative Motion – True Trails
- **TM** True Motion

In **Relative Motion – Relative Trails**, own ship is displayed at a fixed point in the video circle (normally the centre) and all target trails are shown relative to own ship's movement. This means that stationary targets will have trails if own ship is moving.

In **True Motion**, own ship moves across the video circle. Stationary targets, therefore, don't produce any trails.

True Motion is only available on range scales 0.5NM to 48NM. If the range scale is outside these limits, it will temporarily revert to relative motion – relative trails on a lower range scale and relative motion – true trails on the 96NM range. On selecting a valid range scale it will revert to **True Motion**.

In **Relative Motion – True Trails** modes, own ship is displayed at a selected point in the video circle (normally the centre). However, as with true motion, the target trails show their direction. Therefore, stationary targets do not generate trails. The advantage of this mode over true motion is that a constant range ahead of own ship is always displayed, so there is no need to reset the display.

Relative Motion – True Trails is not available below 0.5NM range scale. If the range scale goes below 0.5NM the display will temporarily revert to relative motion – relative trails. On selecting a valid range scale it will revert to **Relative Motion – True Trails**.

Selecting a Motion Mode

Note – If the radar is in unstabilised (Head-Up) mode, only relative motion will be available.

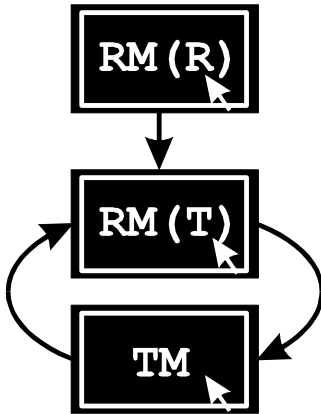

Either

1. Position the screen cursor over the Motion Mode field.
2. Left click consecutively to toggle through the available options.

Note – If RM(R) is the currently selected mode, the first left click will select the RM(T) mode. Subsequent left clicks will then toggle between the TM and RM(T) options only. To select the RM(R) mode use the method described below.

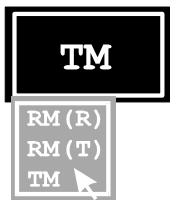

Or

1. Position the screen cursor over the Motion Mode field.
2. Right click to reveal a drop down menu.
3. Within the menu the current selection is highlighted, position the screen cursor over the required mode.
4. Left click to select

Vector Modes

Vectors are shown on the radar display to indicate the velocity (speed and direction) of own ship and moving targets. The length of the vector indicates speed and its bearing indicates direction.

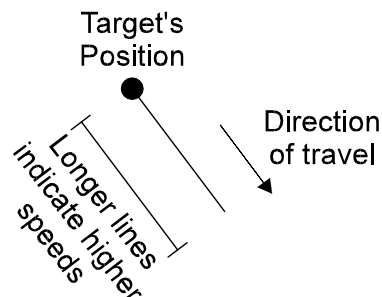
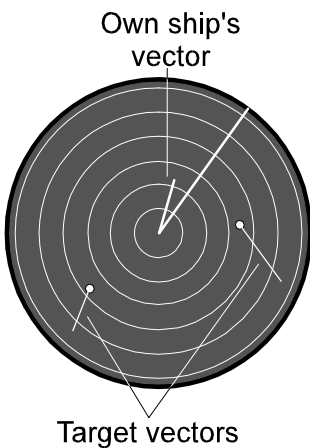

If the system has the AIS option fitted then all target vectors will be dashed. If the system is not AIS fitted then from software version 5.0 it is possible to select whether vectors are dashed (AIS) or solid (STD), see Chapter 8. Earlier software versions have solid target vectors.

This function is only available in Transmit mode and is **not** displayed in Standby.

The Vector selection box is divided into two fields as illustrated below. The currently selected mode is displayed.



The vector mode determines whether the vectors represent the true velocity of targets or their velocity relative to own ship.

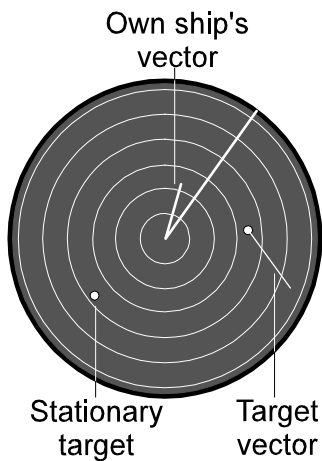

True Vectors All moving targets and own ship have a vector representing their movement (speed and direction) over the water/ground.

Note – There is an option for the user to display an arrowhead on own ship's vector, see Chapter 8. A single arrowhead represents course and speed through the water, and a double arrowhead represents course and speed over the ground.

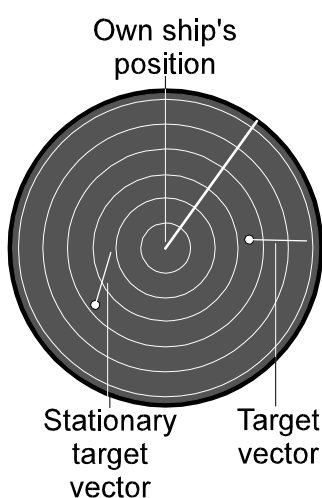

Relative Vectors If own ship is moving, all targets, moving and stationary, have a vector representing their movement (speed and direction) relative to own ship. Own ship will not have a vector in this mode.

Selecting a Vector Mode

A TRUE or REL (Relative) Vector mode can be selected as follows,



1. Position the screen cursor over the Vector mode selection field.
2. Consecutive left clicks will toggle the mode between TRUE (T) and RELATIVE (R) vectors.

Note – *If the selected vector mode is not the same as the current motion mode, the data will be shown in orange. If Vector Timeout has been selected (see Chapter 8) then the vector mode will revert to the same as the motion mode after 30 seconds.*

Selecting a Vector Time

The 'vector time' selected will determine the length of the vectors shown on the radar display. The length of a vector represents the distance the ship/target will travel in the 'vector time', for example;

Vector Time = 5 min
Speed (of ship/target) = 12 kt
Length of Vector = 1 nm

The optimum vector time will depend on the range scale in use.



The Vector Time can be adjusted between 1 and 60 minutes as follows,

1. Position the screen cursor over the vector time field.
2. Left click to access.
3. Move the cursor control left or right to change the time.
4. Left click to accept.

Alternatively a right click will reveal a drop down numeric keypad from which the vector time can be entered. See Chapter 15.

Extending the vector time lets you check on CPAs of targets by projecting their movements further into the future.

Trails Mode

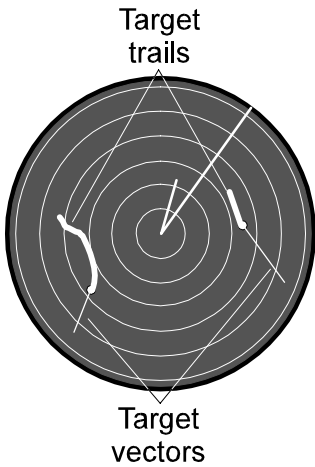

Decaying video trails, showing the history of a target's movements, can be displayed in addition to the target vectors. The manner in which the trails are displayed depends on the motion mode in use. In Relative Motion – Relative Trails (**RM(R)**) the trails indicate the movement of the targets **relative** to own ship. In True Motion and Relative Motion – True Trails (**TM** and **RM(T)**), the trails have own ship's speed applied, and show movement over the ground if selected speed is ground locked, or through the water if the speed is water locked.

The Trail function is only in Transmit Mode and will **not** be displayed in Standby.

When True Motion or Relative Motion – True Trails (TM or RM(T)) is selected the letter 'T' (True Trails) is displayed at the LH side of the text in the Trails display field, otherwise 'R' (Relative Trails) is displayed, see below.



Trail Time

This shows the length of the trails. If the trails have not yet built up to their maximum length, a count-up time is shown indicating how long they have been building up.



Selecting a Trails Mode

A left click reveals a drop down menu containing the trail modes available. The currently selected mode is highlighted. The options available for selection are as follows.



- SHORT** High rate of decay giving a short trail. Actual trail length will depend on the range in use, see table below.
- LONG** Low rate of decay giving a long trail. Actual trail length will depend on the range in use. see table below.
- PERM** Permanent trail which does not decay. When the trail length becomes greater than 99 minutes it is indicated as 'PERM'.
- OFF** Trails removed from display.
- RESET** Keeps the currently selected mode, but resets counter and clears the video.

1. Within the menu, position the screen cursor over the required mode.
2. Left click to select.

The selection of LONG or SHORT alters the trail time and is dependent on the range scale in use. Immediately after selection, the maximum trail time is displayed for a few seconds before being replaced by the count-up time. The table below indicates the maximum trail time, as displayed on the screen. The trail time defaults to SHORT after power up.

Range Scale (nm)	SHORT Time	LONG Time
0.125	10 sec	30 sec
0.25	10 sec	30 sec
0.5	15 sec	45 sec
0.75	15 sec	45 sec
1.5	30 sec	90 sec
3.0	30 sec	90 sec
6.0 and above	60 sec	3 min

Warning Prompts

Presentation Mode Warnings

If an attempt is made to enter a stabilised presentation mode when the compass is on alarm, the following prompt is displayed.

```
Compass error - H UP only
```

Motion Mode Warnings

If an attempt is made to enter True Motion mode or Relative Motion – True Trails (TM or RM(T)) while conflicting parameters are in force, a prompt is displayed as indicated below.

Invalid Range

```
Invalid range for TM
```

```
Invalid range for RM(T)
```

Compass Error

```
Compass error - rel motion only
```

Speed Reference (either LOG or NAV SPEED) error

```
Speed error - rel motion only
```

CHAPTER 6

EBLs, ERBLs and VRMs

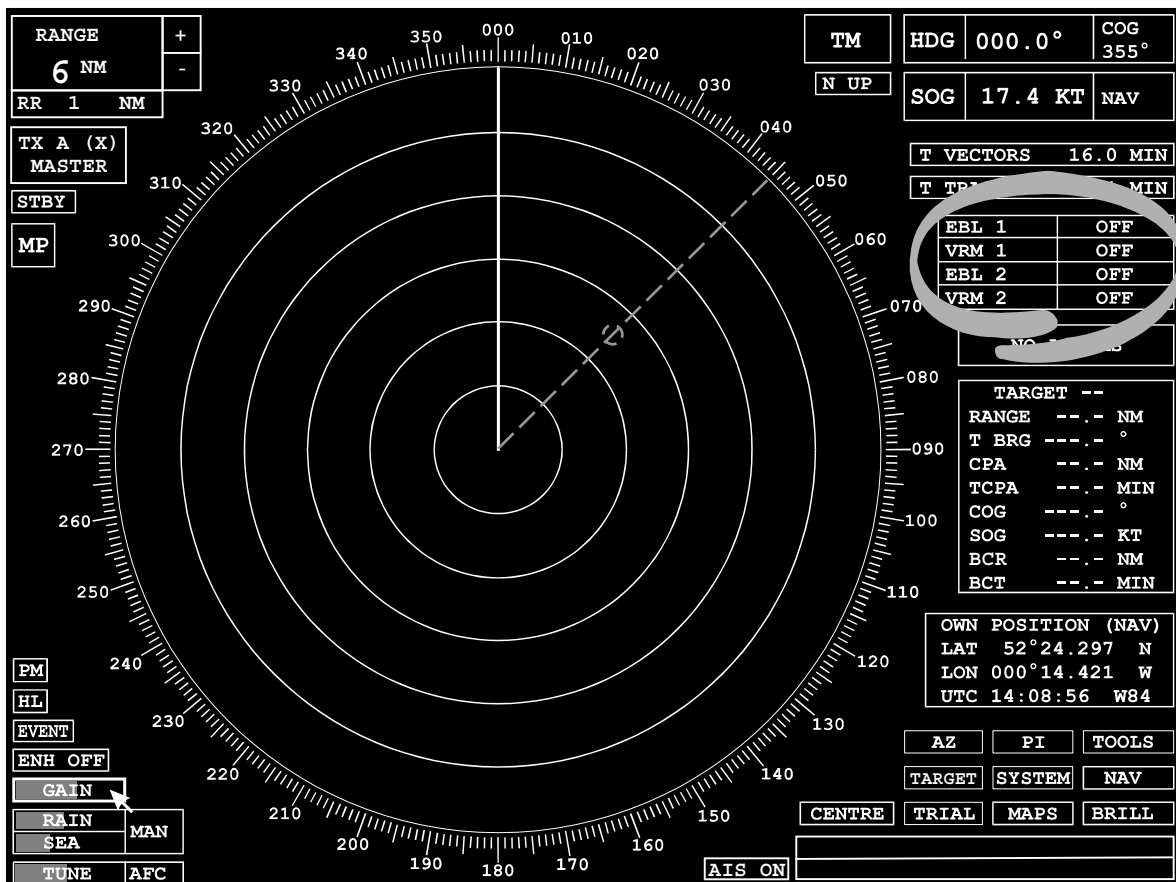

Covered in this chapter:

- Switching Electronic Bearing Lines (EBLs) and Variable Range Markers (VRMs) on and off.
- Changing EBL and VRM settings.
- Using the combined Electronic Range and Bearing Line (ERBL).
- Selecting EBL and VRM options.

EBL 1	OFF
VRM 1	OFF
EBL 2	OFF
VRM 2	OFF

Introduction

Two **EBLs** (Electronic Bearing Lines) two VRMs (Variable Range Markers) are available and can be displayed simultaneously in the video circle. They are available in both Standby and Transmit modes.

VRM1 is always associated with EBL1 and VRM2 with EBL2. Both VRMs and EBLs default to OFF.

In Standby mode, ranges and bearing are measured relative to the centre of the video circle rather than the turning unit position. When switching between Standby and Transmit modes all EBLs and VRMs are turned OFF.

If an EBL is turned ON while its associated VRM is turned OFF, then the EBL is displayed as an **ERBL** (Electronic Range and Bearing Line).

ERBL1	005.0 ° T
VRM1 OFF	2.5 NM
EBL 2	355.0 ° T
VRM 2	4.5 NM

When an EBL, VRM or ERBL is switched ON the range and bearing values associated with it are displayed to the right of its caption.

Electronic Bearing Line (EBL)

EBLs can be turned ON or OFF independently. Any settings are remembered when they are switched OFF.

Turning EBLs ON and OFF



1. Position the screen cursor over the **EBL** caption box.
2. Left click to toggle ON or OFF.

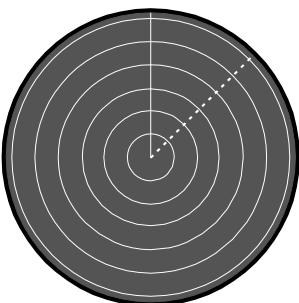

An EBL is displayed as a dashed white line in the video circle.

Note – Each EBL and its associated VRM are identified by having the same mark/space ratio for the line/ring.

ERBL1	045.0 ° T
VRM1 OFF	2.5 NM

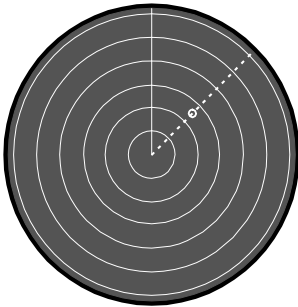

If an EBL is turned ON while its associated VRM is turned OFF, then the EBL is displayed as an ERBL with a small circle positioned on the bearing line to indicate the range (providing it is within the range of the video circle).

EBL 1	045.0 ° T
-------	-----------

ERBL1	045.0 ° T
VRM1 OFF	2.5 NM

Changing the Bearing of an EBL or ERBL

1. Position the screen cursor over the bearing.
2. Left click to access.
3. Move the cursor control left or right to change the bearing.
4. Left click to accept.

Alternatively a right click will reveal a drop down numeric keypad from which the bearing can be entered. See Chapter 15.

The **range** of an ERBL can be changed in the same way.

Depending on the presentation mode selected (see Chapter 5), the letter **T** is displayed to indicate a **true** bearing or the letter **R** for **relative**.

Direct ERBL Control

To control the range and bearing of an ERBL from within the video circle.

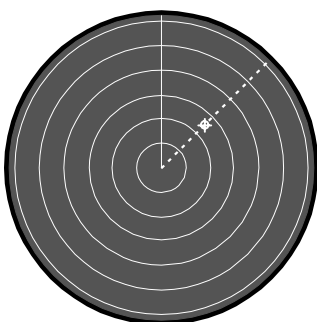

1. Position the screen cursor (+) over the small VRM circle on the EBL.
2. Press and hold down the left key.
3. Move the cursor control in any direction to change the ERBL settings.
4. Release the key to accept.

Note – If the small VRM circle is over a target, a single key click is associated with that target. It is therefore essential to keep the left key pressed when changing the ERBL settings.

Variable Range Marker (VRM)

The two VRMs can be turned ON or OFF independently. Any settings are remembered when they are switched OFF.

Turning VRMs ON and OFF

1. Position the screen cursor over the VRM caption box.
2. Left click to toggle ON or OFF.

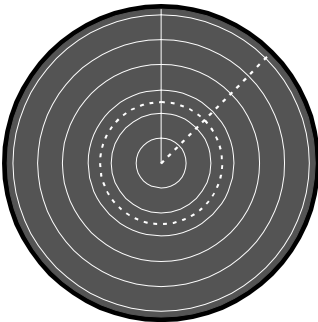

A VRM is displayed as a dashed white ring in the video circle.

Changing the Range of a VRM

1. Position the screen cursor over the range.
2. Left click to access.
3. Move the cursor control left or right to change the range.
4. Left click to accept.



Alternatively a right click will reveal a drop down numeric keypad from which the range can be entered. See Chapter 15.

Combined VRM and EBL Control

To control a VRM and its associated EBL from within the video circle.

1. Position the screen cursor (+) over the intersection of the VRM and EBL.
2. Press and hold down the left key. The cursor will change to a small circle.
3. Move the cursor control in any direction to change the range and bearing.
4. Release the key to accept.

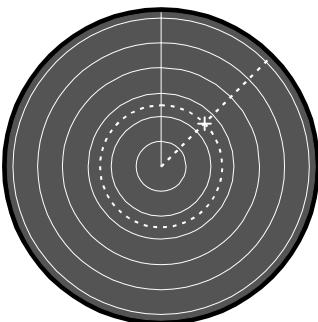

Note – If the intersection of an EBL and its associated VRM is over a target, a single key click is associated with that target. It is therefore essential to keep the left key pressed when changing the VRM and EBL.

Rapid Range and Bearing Readings

For rapid range and bearing readings, use the following procedure.

1. Move the cursor into the video circle and position over the item of interest.
2. Press and hold down the left key.
ERBL1 will switch ON if it was not previously ON, and the range and bearing of the ERBL (or EBL and VRM if they were ON) will be set automatically.
3. Release the left key.

Options

EBL2/VRM2 can be either **centred** or **off-centred** (EBL1/VRM1 can only be **centred**). When centred, EBL2/VRM2 are displayed with their origin at the turning unit position. When off-centred there are two further options, **dropped** or **carried**. When carried in a stabilized mode, the off-centred position is at a constant true bearing and range from the turning unit. When carried in unstabilised mode the off-centre position will be at a constant relative bearing and range. When dropped they remain at a fixed position on the ground or on the water depending on whether the speed in use is 'speed over the ground' or 'speed through the water'. The dropped option is not available in H-Up presentation mode. The default settings are Centred and Carried.

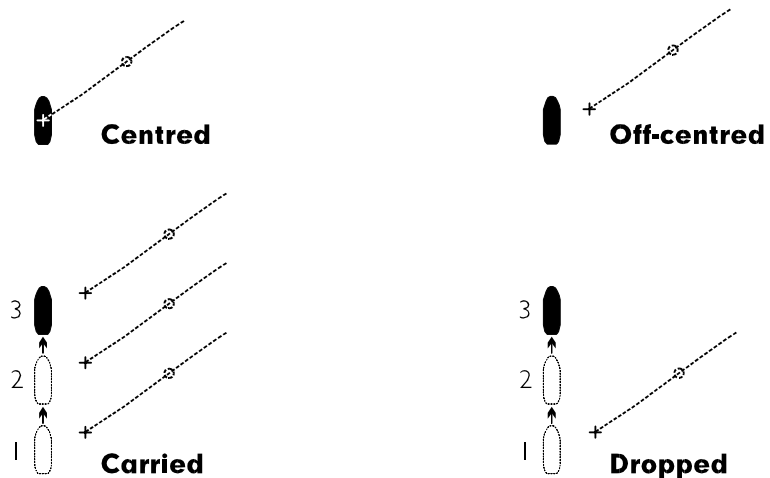



A letter (**D**) is displayed in the EBL caption box if dropped is selected.

A letter (**C**) is displayed in the EBL caption box if carried is selected.

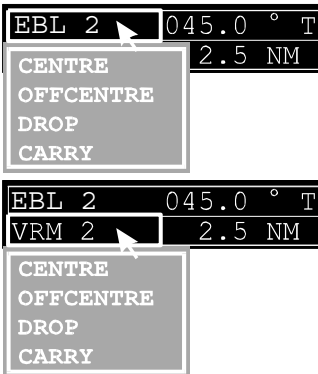

To select the required option (For EBL2/VRM2 ONLY)
Either EBL2 or VRM2 must be ON.

1. Position the screen cursor over the EBL2 or VRM2 caption box.
2. Right click to reveal the drop down menu.
3. Move the screen cursor to the required option.

If **OFFCENTRE** is selected the screen cursor is re-positioned at the centre of the video circle leaving the drop down menu in place.

- a) Move the cursor (+) to the required off-centre location.
- b) Left click to select, the screen cursor returns to the EBL2/VRM2 caption box and the EBL/VRM is redrawn at the new position. Carried will be the mode selected by the default.
- c) To change the Carry or Drop option, right click on the EBL2/VRM2 caption box.
- d) Move the cursor to the Carry or Drop option.
- e) Left click to select.

Defaults

If the radar is in a stabilised mode (North Up or Course Up), the bearing of EBLs is true (ie with respect to true north), if unstabilised (Head Up) the bearing is relative to own ship's heading line. Switching between stabilised and unstabilised modes causes both EBLs and VRMs to revert to their default values. They are also turned OFF if previously set to ON.

As stated earlier, EBL1/VRM1 can only be centred, whereas EBL2/VRM2 can be either centred or off-centred. Any changes to the start position of EBL2 is also applied to the centre of VRM2. If an off-centred VRM2 is turned ON without its associated EBL (EBL2), its centre is marked with a small filled circle.

The default bearing for EBL1 is 5.0° and for EBL2, 355°.

The default range for VRM1 is 2.5 nm and for VRM2, 4.5 nm.

The range of the VRMs is limited to one and two-thirds times the range scale in current use. When a change of range scale causes the limit to be exceeded, the VRM range remains unchanged until the VRM is altered. When it is altered, it immediately jumps to the limiting range and is not permitted to increase beyond the limit. These restrictions also apply in ERBL mode.

Warning Prompt

If the distance between the EBL 2 origin and own ship exceeds five times the selected range scale, it and its associated VRM are automatically centred and returned to their default values. A warning prompt is also displayed.

EBL 2 and VRM 2 re-centred

Intentionally Blank

Acquisition, Plotting and Zone Functions

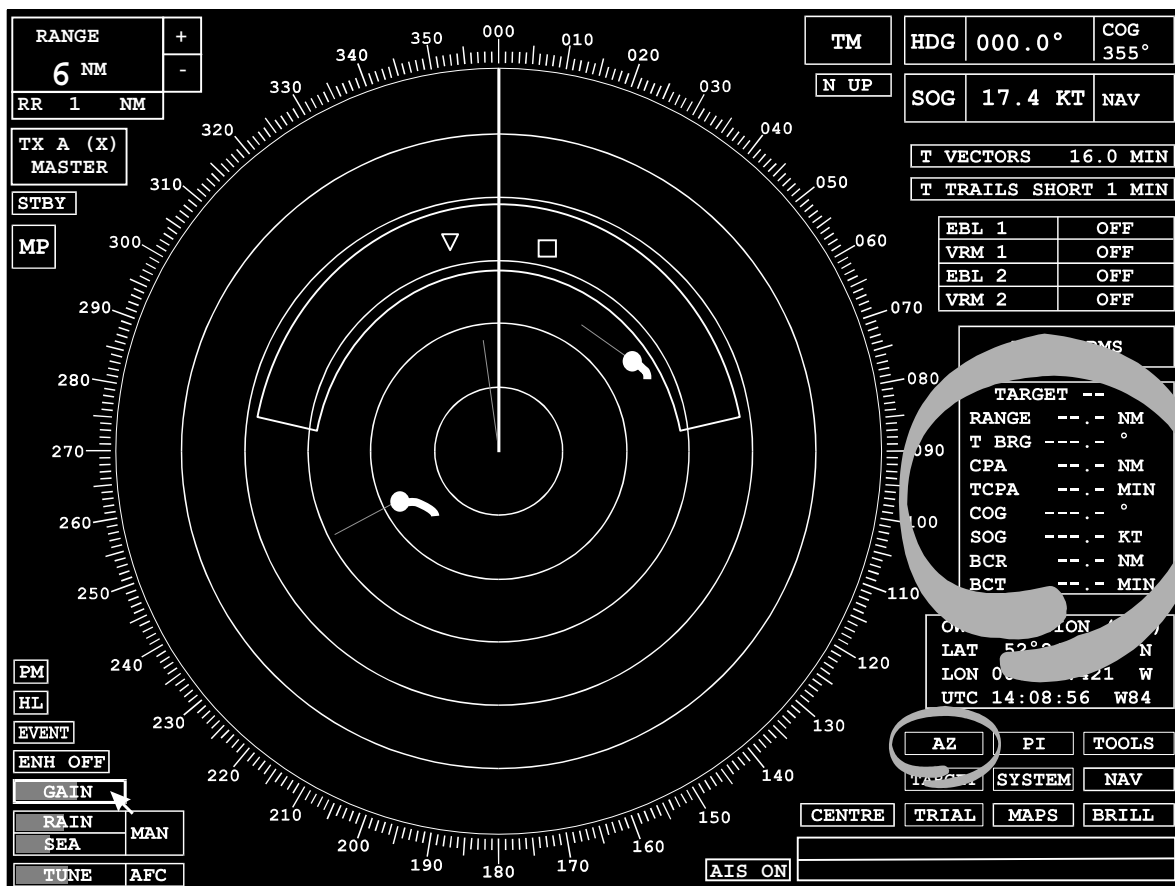

Covered in this chapter:

- Plotting a target by manually plotting its position at intervals.
- Manually acquiring a target for tracking.
- Automatically acquiring a target for tracking using auto-acquisition zones.
- Defining auto-acquisition and guard zones.
- Displaying target data.
- Description of Automatic Identification Option (AIS) and its features.

Introduction

In transmit mode, any target that appears on the radar display within the range of 0.25 to 40 nm can be plotted or tracked. The method used is either manual target plotting (EPA radars only) or target acquisition and auto-tracking (ATA and ARPA radars only). Once a target has been plotted or acquired, information relating to the target's proximity to own ship and its speed and bearing is maintained until the target is 'cancelled'.

An option for ATA and ARPA's is to display AIS information instead of tracked or acquired data, see AIS functions.

Autotrack and AIS synthetics are not displayed on the 0.25NM and 0.125NM ranges

Information on one or more tracked targets can be displayed in a target box, see **Target Data** later in this chapter.

An indication of how your radar is configured, is given by the caption in the radar function soft keys, see examples on the left.

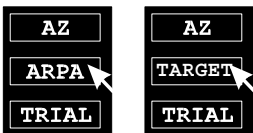

The caption will show an **AZ** and **TRIAL** function for **ARPA** (Automatic Radar Plotting Aid).

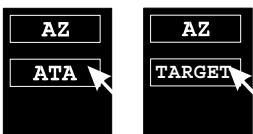

The caption will show an **AZ** but no **TRIAL** function for **ATA** (Automatic Tracking Aid).

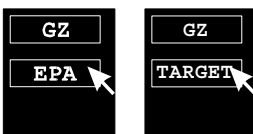

The caption will show **GZ** function for **EPA** (Electronic Plotting Aid).

Depending on the version of software **EPA**, **ATA**, **ARPA** or **TARGET** will be displayed as the caption for the **TARGET** soft key.

In this chapter, the plot functions associated with EPA radars are explained first, followed by acquisition and zone functions for ATA/ARPA radars later in the chapter.

Electronic Plotting Aid (EPA) Radars

Manual Plotting of Targets (EPA)

Manual plotting is only available in stabilized modes. When manually plotting a target, the initial position of the target is marked and then the target position is marked again after a suitable time interval. From the two position marks and the interval between plots, the target's speed and course is calculated and displayed as a target vector (see Vector Mode in Chapter 5).

PLOT nn			
TIME	nn.n	MIN	
RANGE	nn.n	NM	
T BRG	nnn.n		
CPA	nn.n	NM	
TCPA	nn.n	MIN	
CSE	nnn.n		
STW	nn.n	KT	
BC	nn.nNM	nnMIN	

Before plotting a target, the user must select the required plot number by left or right clicking on the title line of the plot tote area. Any actions in the video circle will apply to the plot displayed in the tote. Manual plots are numbered from 1 to 10.

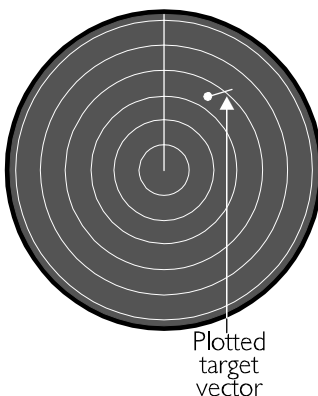

Plotting a Target

1. Position the cursor over the target in the video circle.
2. Left click to mark the target's initial position. (A second left click over the target, within 12 seconds, can be used to reposition it.)
3. After a minimum of 30 seconds, left click on the target again to mark its second position. The velocity of the target is then calculated and the target vector display accordingly. The vector position will be updated approximately once every scan taking own ship's motion into account, but a constant velocity is assumed for the target.
4. Continue plotting, by left clicking on the target, in order to update the calculated velocity and the target vector. Ensure that the target's associated plot number is displayed at the top of the tote area when updating.

Note – If a plot has not been updated for 10 minutes, a PLOT UPDATE alarm is raised. If the calculated velocity is greater than 150 kt, the prompt 'Plot distance too big' is displayed and the plot is ignored.

Cancelling Manual Plotting

1. Position the cursor over a plotted target in the video circle.
2. Right click to cancel the target plotting.
The target vector and associated target information are removed from the target.

Note – *Target plots will be cancelled automatically if their range exceeds the maximum plotting range or the time since the last plot exceeds 15 minutes.*

Manual Plotting Limitations

- Manual plotting is only available on the range scales from 0.5 to 48 nm.
- If the compass fails, it will not be possible to plot any more targets, and after 1 minute all target plots are cleared.
- If the radar is switched to unstabilised presentation modes, all target plots are automatically cleared.
- If the radar is switched to standby, all target plots will be cancelled automatically.

Manual Plotting Alarm Symbols

If an alarm is raised against a plotted target currently in the video circle, an alarm symbol is displayed (see below). This symbol flashes until the alarm is acknowledged. The alarm symbol then remains displayed as long as the alarm condition exists. Even if the target is not currently displayed in the video circle, an alarm will still be raised. The following alarm symbols, listed in order of priority, are used.

- ⚡ If a plotted target infringes the bow crossing limits, a BOW CROSS alarm is raised.
- △ If a plotted target infringes the CPA or TCPA limits, a CPA/TCPA alarm is raised.

If the interval between plots exceeds 10 minutes, a PLOT UPDATE alarm is raised, and the plot number associated with the target will flash in RED, even if the PLOT ID is set to OFF.

Plot Data (EPA)

Manually Plotted Target Data

The following data is shown;

PLOT	nn	
TIME	n.n	MIN
RANGE	nn.n	NM
T BRG	nnn.n	°
CPA	nn.n	NM
TCPA	nn.n	MIN
CSE	nnn.n	°
STW	nn.n	KT
BC	nn.nNM	nnMIN

PLOT	Target identification number.
TIME	The time elapsed since the last plot was made.
RANGE	Range of target from own ship.
T BRG	Bearing of target from own ship relative to true north.
CPA	Closest point of approach to own ship.
TCPA	Time to closest point of approach.
CSE/COG	Target's Course through the water (CSE) or Course Over the Ground (COG).
STW/SOG	Target's Speed Through the Water (STW) or Speed Over the Ground (SOG).
BC	Bow crossing distance and time.

The target, for which data is shown, can be selected by right clicking on the title in the plot tote area to reveal a numeric pad. A left click on the title allows the number to be changed by moving the cursor control. The selected target is identified in the video circle a green over the target.

Note that the Range and Bearing of a target is the Range and Bearing as measured from the Turning Unit (Radar Head). All target calculations are made with respect to the Radar Head.

Closest Approach and Bow Crossing Limits

The CPA, TCPA and BC (distance and time) can be viewed and changed as follows.

To View the Limits

1. Position the screen cursor over the appropriate line in the plot tote area (CPA/TCPA, BC(distance) or BC(time).
2. Press and hold down the left key.
The entered limit for the selected parameter is displayed in yellow for as long as the key is kept pressed.
3. Release the key.

Note – Bow crossing information is not available on static radar installations

To Change the Limits

A right click on the CPA, TCPA, BC(distance) or BC(time) lines will reveal a drop down numeric keypad from which the required limit can be entered, see Chapter 15. Alternatively, the limits can be changed via the EPA menu, see Chapter 8.

Guard Zones (EPA)

If the system is configured as an EPA then guard zones will be available instead of auto-acquisition zones. In this case, a **GZ** soft key is used to select and define guard zones.

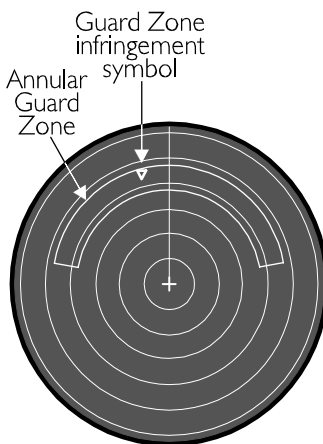
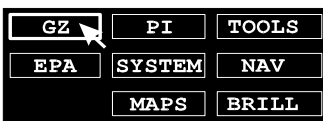

Two annular guard zones are available which are always displayed relative to own ship's head. Guard zones are active on all ranges but can only be displayed on the 3, 6 and 12 nm range scales in all motion and presentation modes.

When a target enters a guard zone a GZ ENTRY alarm is raised.

If 60 infringements have been detected, a ZONES FULL alarm is raised.

Accessing the Guard Zones Menu

1. Position the screen cursor over the GZ soft key.
2. Left click to reveal the Guard Zones menu shown on the left.

A left click on the EXIT GUARD ZONES soft key will close the GUARD ZONES menu.

Turning Guard Zones On/Off

Note – Guard zones retain their definitions when turned off.

1. Position the screen cursor over a ZONE line in the menu.
2. Left click to toggle the selected zone ON and OFF.

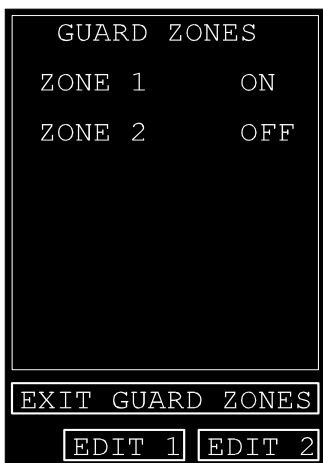

Defining a Guard Zone

Note – *A guard zone is not active while it is being defined.*



1. Position the cursor over an EDIT soft key.
2. Left click to select edit mode for the associated guard zone. The selected zone is displayed in a different colour and the associated ZONE ON/OFF line in the menu shows EDIT.
The other zone will temporarily be displayed at its last setting for reference purposes (provided the range in use is suitable), but will not detect any infringements unless it is currently ON.
3. Edit the zone as described in **Annular Zone Editing** later in this chapter.
4. When creating a completely new guard zone (ie without dragging) it will automatically store the new zone and switch it on.
5. If editing an existing guard zone, select either the EDIT soft key for that GUARD ZONE or the EXIT GUARD ZONES soft key to store the new zone and switch it on.

Automatic Targeting and Radar Plotting Aid Radars (ATA/ARPA)

Target Functions (ATA/ARPA)

Targets can be acquired manually by the operator or automatically using operator definable auto-acquisition zones. When a target enters an auto-acquisition zone, an alarm is raised and the target is automatically 'acquired'. Auto acquisition zones are available in all presentation and motion modes. Targets cannot be acquired within 0.25 nm of own ship.

Target Tracking Limitations

- When the maximum number of targets are being tracked, the TRACKS FULL alarm is raised and another target cannot be acquired until one or more targets are cancelled or automatically dropped.
- If the radar is switched to standby, all targets will be cancelled automatically.
- Already acquired targets are dead reckoned (**DR**) when within 0.25 nm of own ship.

The integrity of ARPA and ATA tracking is a function of many variables which include clutter conditions, signal-to-noise ratio, sensor errors (log, compass, nav input etc), scanner speed, speed and manoeuvrability of the target and the number of targets being tracked. The design of the tracker minimises the effects of these errors but the operator must be aware that such errors will produce discrepancies in derived tracked target information such as true speed, course, bearing, CPA and TCPA.

The tracker can track targets with relative speeds of up to 150kts.

The possibility of target swop is minimised by the use of damped plot predictions in the tracker. The ARPA and ATA tracker employs advanced rain and sea clutter rejection techniques independent of the display settings. A fully established tracked target will not be affected by large levels of sea or rain clutter, however attempting to acquire a target at close range in severe clutter conditions, may

cause the occasional appearance of the lost target symbol and its associated alarm.

When changing from one speed mode to another, and particularly between a water speed and a ground speed mode, the vectors take some time to resettle. Three minutes should be allowed to obtain full accuracy when switching between speed modes.

AIS Functions (Option)

If the system has the AIS option fitted, together with an AIS input from an AIS system via the serial interface unit, then AIS targets will be automatically displayed on the screen when in transmit.

The data from the AIS input is ground referenced to the LAT/LONG grid and therefore it is essential that the COMPASS and HM OFFSETs are set accurately to ensure correlation between the radar video and the AIS symbol. Own ships position from a GPS must be available for the AIS information to be displayed. All AIS target data is derived from the information received and not any radar tracking data.

The AIS vectors and tote data will be shown using the speed reference being used. All AIS vectors are shown as dashed lines.

AIS targets do not have a maximum range for display of 40NM.

AIS target alarms work in the same way as autotrack targets for Bow Crossing, CPA/TCPA and AZ Entry. There is also a lost target alarm but the criteria for declaring a lost target are different.

All AIS targets (sleeping or activated) raise an alarm when they infringe either the Bow Crossing Limit, CPA/TCPA limit or enter an acquisition zone.

Compass Errors

If targets are being tracked, a compass error will cause affected target data to change from green to red. The affected data being TBRG, CPA, TCPA, COG (or CSE), SOG (or STW), BCR and BCT. After 1 minute all targets will be cancelled; auto acquisition zones and the constant radius turn will be switched off and it will not be possible to use these facilities, or select a stabilised mode, until a valid compass heading is available. The system will reset to the H-Up presentation mode.

Target Alarm Symbols

If an alarm is raised against a target currently in the video circle, a red alarm symbol is displayed. This symbol flashes until the alarm is acknowledged. The alarm symbol then remains displayed as long as the alarm condition exists.

Even if the target is not currently displayed in the video circle, an alarm will still be raised. An unacknowledged alarm always has a higher priority than an acknowledged alarm. The following alarm symbols, listed in order of priority, are used.

- ◇ If the radar hasn't been able to obtain successfully the position of a target, which is being used as an echo reference, during the last three radar scans, a LOST REF alarm is raised.
- ⚡ If a target infringes the bow crossing limits, a BOW CROSS alarm is raised.
- △ (Non AIS) If a target infringes the CPA and TCPA limits, a CPA/TCPA alarm is raised.
 ↗ (AIS) (For AIS, the alarm symbol points in the direction of the vessels heading)
- ▽ When a target enters an auto-acquisition zone, an AZ ENTRY alarm is raised.
- ◇ (Non AIS) If the radar hasn't been able to obtain successfully a non AIS target's position during the last six radar scans, a LOST TARGET alarm is raised.
- ✂ (AIS) If the radar hasn't received data on an activated AIS target for at least 12 seconds a LOST target alarm is raised. The actual time depends on the speed of the target. The alarm symbol is the red bar, which is overlaid across the orientated green AIS symbol.

Manual Acquisition of Targets (ATA/ARPA)

Manual acquisition is only available on range scales of 0.5 nm and above. When a target is acquired it is automatically assigned an identification number. Target numbering always starts at 1 and goes up to a maximum of 60 (80 for AIS option). A target is assigned the next number in the sequence. Up to 60 targets can be acquired manually (only 40 for AIS option). Gaps which occur due to targets being cancelled or dropped, are not filled until the maximum number has been reached.

Acquiring a Target

1. Position the cursor over the target in the video circle.
2. Left click to acquire the target.

An initial tracking symbol is displayed centred on the target's estimated position. After 16 good plots, this initial tracking symbol is replaced by the target vector indicating the acquired target's speed and direction – see Vector Mode in Chapter 5.

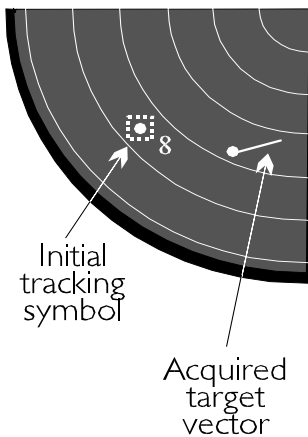

Note: When using the enhance facility, position the cursor over the nearest anti-clockwise edge of the target video to acquire the target.

Cancelling Target Acquisition

1. Position the cursor over an acquired target in the video circle.
2. Right click to cancel the target acquisition.
The target vector and associated target information are removed from the targets.

AIS Display of Targets

The positions of all received AIS targets are checked and only the nearest 40 AIS targets will be displayed. In addition to this, 40 manual/auto tracked targets can also be displayed.

There are two different types of AIS targets, sleeping and activated.



Sleeping target

A sleeping AIS target symbol is a green isosceles triangle pointing in the direction of the vessel's heading. If the vessel's heading is unavailable then the vessel's course information will be used instead, and if that is unavailable the triangle will point North.



Activated target

An activated target symbol has the same green isosceles triangle as a sleeping target above. Also the symbol will have a dashed vector pointing in the direction of the vessel's course based on the display presentation (true/relative) and speed reference (ground/water), and a solid line of fixed length from the apex of the triangle in the direction of the vessel's true heading. This heading line will also have a perpendicular turn indicator drawn at the end of the heading line, if the vessel is turning at a sufficient rate. If either the AIS course or speed information is unavailable then a red dot at the apex of the triangle will replace the dashed vector.

An AIS target will replace an autotrack target at the same position, as an activated AIS target. There is an association condition to determine this. See **Target Association** in Chapter 8. If there is no autotrack target to associate, then it will be displayed as a sleeping AIS target

When a new AIS target is displayed, it will be assigned an identification number. Target numbering starts at 1 and goes up to a maximum of 80. The target numbers are not separated between AIS and autotrack targets.

It is not possible to manually acquire an AIS target when AIS is switched on.

Activating a target

1. Position the cursor over the AIS target in the video circle.
2. Left click to activate the target.

Targets are automatically activated when included in a multi-target tote, or when they cause an alarm to be raised.

Selecting a target

1. Position the cursor over the activated AIS target in the video circle.
2. Left click to select the target for tote display

When a target is selected for tote display it will also display a dashed tote target symbol.

Deactivating a target

1. Position the cursor over the activated AIS target in the video circle.
2. Right click to deactivate the target.

The AIS vector and heading line will be removed from the display. Deactivating the target will not deselect the target, and if it is selected, data will remain in the tote box.

If either the velocity data or heading data is missing, then the symbol will change as shown below.

Auto dropping or auto acquiring of AIS targets

Activated AIS targets will be automatically acquired as an autotrack target if they are no longer within the 40 nearest targets, or if they become a lost target (but only after the alarm has been acknowledged). If this occurs, some target vector manoeuvres may be observed

Sleeping AIS targets will be automatically dropped if they are no longer within the 40 nearest AIS targets, or if they become lost targets. However if they are being used in any target tote or for track history, then they will be automatically acquired.

AIS Target Symbols



Sleeping Target. Green isosceles triangle.

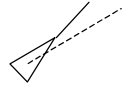

Activated Target. Green.

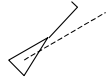

Activated Target with turn indicator. Green.



Activated target with missing velocity data. Red dot at apex of triangle.



Activated target with missing heading data. Green.



Activated target with missing velocity and heading data. Red dot at apex of triangle.



Selected sleeping target. Green.

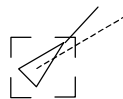

Selected activated target. Green.

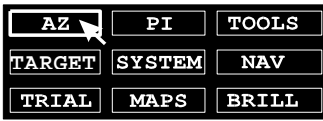

Auto-Acquisition Zones (ATA/ARPA)

If the system is configured as an ATA or an ARPA then auto-acquisition zones will be available. In this case, an **AZ** soft key is used to select and define the zones.

Two annular and two polygonal acquisition zones are available, they are displayed relative to own ship's head. Auto-acquisition zones can only be displayed on range scales from 0.75 nm to 96 nm (annular zones), or from 0.5 nm to 96 nm (polygonal zones).

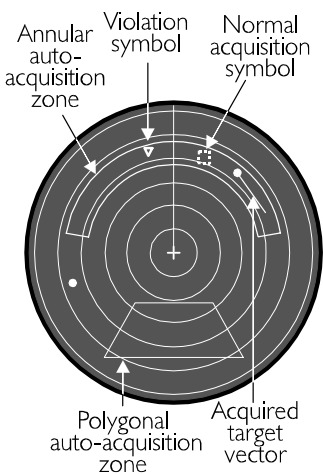

When a target enters an auto-acquisition zone, an AZ ENTRY alarm is raised and the auto-acquisition zone violation symbol is displayed. This flashes until the alarm is acknowledged, when the violation symbol is replaced by the normal acquisition symbol for a non AIS target. After 16 good plots, the normal acquisition symbol is replaced by the target vector indicating the acquired target's speed and direction – see Vector Mode in Chapter 5.

If a sleeping AIS target enters an auto-acquisition zone it will automatically be activated.

When a target is acquired it is automatically assigned an identification number. Target numbering always starts at 1 and goes up to a maximum of 60 (80 for AIS system). A target is assigned the next unused number.

Accessing the Auto-acquisition Zones Menu

1. Position the screen cursor over the AZ soft key.
2. Left click to reveal the AUTO ACQ ZONES menu shown on the left.

A left click on the EXIT ACQ ZONES soft key will close the AUTO ACQ ZONES menu.

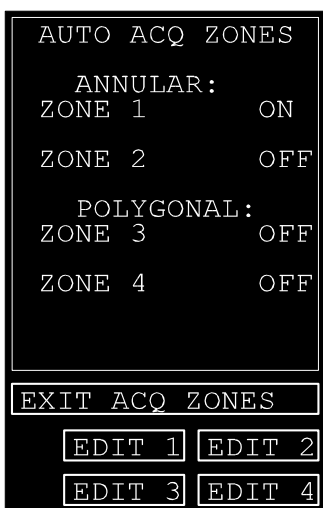

Turning Acquisition Zones On/Off

Note – Acquisition zones retain their definitions when turned off.

1. Position the screen cursor over a ZONE line in the menu.
2. Left click to toggle the selected zone ON and OFF.

Note – If an attempt is made to switch on a zone which exceeds systems capacity, the following prompt will be displayed.

Not enough room - Switch off other zones

Defining an Acquisition Zone

Note – An acquisition zone is not active while it is being defined.



1. Position the cursor over an EDIT soft key.
2. Left click to select edit mode for the associated zones. All other zones will temporarily be displayed at their last settings for reference purposes (provided the range in use is suitable), but will not detect any infringements unless they are currently ON. The selected zone is displayed in a different colour and the associated ZONE ON/OFF line in the menu shows EDIT.
3. For zones 1 and 2, edit the zones as described in **Annular Zone Editing**. For zones 3 and 4, edit the zone as described in **Polygonal Zones Editing**.
4. When creating a new zone (ie without dragging) it will automatically store the new zone and switch it ON.
5. If editing an existing Annular Zone, select either the EDIT soft key for that ZONE or the EXIT ACQ ZONES soft key to store the new zone and switch it on.

Annular Zone Editing

The following procedures apply to both guard zones (EPA Radars) and annular auto-acquisition zones (ATA/ARPA Radars).

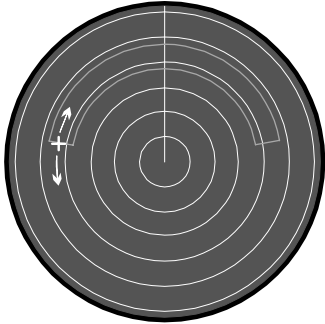

Changing the Start/Stop Bearing

1. Position the cursor over the start or stop bearing as required.

Note – *If the zone is a complete annulus, the start/stop bearing line will be displayed as an aid to editing.*

2. Press and hold down the left key.
3. Drag the start or stop bearing to its new position.

Note – *If the zone is a complete annulus, dragging the bearing line alters the start bearing.*

4. Release the key.

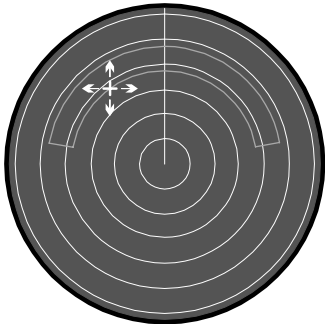

Changing the Range of a Zone

1. Place the cursor over the inner arc of the annulus.
2. Press and hold down the left key.
3. Drag the entire zone to its new position.
4. Release the key.

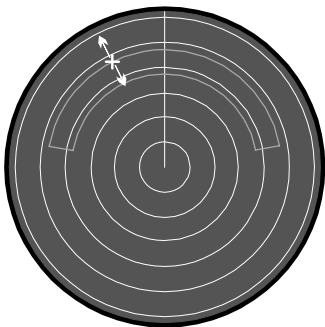

Altering the Depth of the Zone

Note – *This is only applicable to auto-acquisition zones, which can be adjusted from 0.4nm to 2nm. Guard zones are fixed at 0.4nm depth.*

1. Place the cursor over the outer arc of the annulus.
2. Press and hold down the left key.
3. Drag the outer arc to its new position.
4. Release the key.

Creating a New Zone

1. Place the cursor, away from the original zone, at the required start bearing and range.
2. Left click to define the initial range and bearing.
3. Left click again to define the end bearing and depth for the acquisition zone.

Notes

Left clicking twice on the same point will define a complete annulus. The minimum width of a zone is 6° and the maximum is 354°, or 360°. Attempting to define a zone of more than 354° will result in a full 360° zone.

Polygonal Zone Editing (ATA/ARPA)

The following procedure only applies to polygonal auto-acquisition zones. Each time a zone is selected for editing it must be created from scratch and the existing zone definition will be overwritten.

Important Note – Any part of a polygonal zone area within 1 nm of own ship will not detect new targets.

Defining a Zone

1. Left click at the required position to define the start point.
2. Left click again to define the next point. A mauve line will appear joining this point to the previous point.
3. Continue defining points by left clicking. A right click will delete the last line drawn.
4. Complete the polygon either by left clicking again on the start point, or by defining ten points (when it will be closed automatically). The zone will be switched-on automatically on completion.

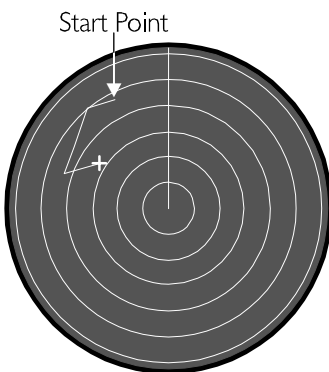

Editing Warning Points

The self explanatory warning prompts listed below are associated with Polygonal Zone editing.

Angle too small (if $<15^\circ$)

This side cannot cross another side

Zone too large

Point is too far away

Side too short

Target Data

The target tote defaults to showing data for a single target.

Acquired Target Data

The following data is shown.

TARGET	nn/name
RANGE	nn.n NM
T BRG	nnn.n
CPA	nn.n NM
TCPA	nn.n MIN
CSE	nnn.n
STW	nn.n KT
BCR	nn.n NM
BCT	nn MIN

TARGET	Target identification number/name and ✓ symbol if AIS.
RANGE	Range of target from own ship.
T BRG	Bearing of target from own ship.
CPA	Closest point of approach to own ship.
TCPA	Time to closest point of approach.
CSE/COG	Target's Course through the water (CSE) or course Over the Ground (COG)
STW/SOG	Target's Speed Through the Water (STW) or Speed Over the Ground (SOG).
BCR	Bow crossing range.
BCT	Bow crossing time.

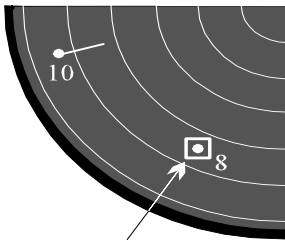

Selected Target is shown with a box around it

The target, for which data is shown, is selected by left clicking on that target in the video circle. The selected target is identified in the video circle by a small square (dashed or solid) symbol centred on the plot origin.

If the target is an AIS target left click on a selected target will toggle between the target tote and the AIS information tote.

Note that the Range and Bearing of a target is the Range and Bearing from the Turning Unit (Radar Head). All target calculations are made with respect to the Radar Head. Any suspect data (ie due to a sensor error) will be displayed in red.

Closest Approach and Bow Crossing Limits

The CPA/TCPA and BCR/BCT limits can be viewed and changed as follows.

To View the Limits

1. Position the screen cursor over the appropriate line in the target box (CPA, TCPA, BCR or BCT).
2. Press and hold down the left key.
The entered limit for the selected parameter is displayed in yellow for as long as the key is kept pressed.
3. Release the key.

To Change the Limits

A right click on the CPA, TCPA, BCR or BCT lines will reveal a drop down numeric keypad from which the required limit can be entered, see chapter 15.

Alternatively, the limits can be changed via the LIMITS & SETTINGS option of the TARGET menu, see chapter 8.

Changing the Data Shown in the Target Box

1. Right click on the top line in the target box to reveal the drop down menu shown on the left. The current selection is highlighted.
2. Position the cursor over the required option in the menu.
3. Left click to select.

A left click on the top line of the target box will toggle between the single target display and the last multi target display that was selected, CPA is the default at start up.

```
TARGET nn/name  
RANGE nn.n NM  
T BRG nnn.n  
CPA nn.n NM  
TCPA nn.n MIN  
CSE nnn.n  
STW nn.n KT  
BCR nn.n NM  
BCT nn MIN
```

```
SINGLE TARGET  
MULTI TARGET BY CPA  
MULTI TARGET BY RANGE  
MULTI TARGET (USER)  
AIS INFORMATION
```

Multiple Target Displays (ATA/ARPA)

For each target in a multi-target tote, its ID number, an isosceles triangle if it is an AIS target, TCPA and CPA are shown. Also its ID number is shown against the target in the video circle together with a tote target symbol. A left click on any of the targets in the list will switch to the single target display for that target.

TARGET (CPA)		
ID	TCPA MINS	CPA NM
02	4.7	3.6
01	3.2	4.8
03	5.7	7.2
--	--.-	--.-
--	--.-	--.-
--	--.-	--.-

Viewing Multiple Targets in Order of CPA

On selection of the MULTI TARGET BY CPA display option, up to 6 targets are listed in order of their CPA (lowest CPA at the top of the list) as shown in the example on the left. Targets with negative TCPA's will not be shown in the list.

TARGET (RANGE)		
ID	TCPA MINS	CPA NM
01	-3.2	4.8
02	4.7	3.6
03	5.7	7.2
--	--.-	--.-
--	--.-	--.-
--	--.-	--.-

Viewing Multiple Targets in Order of Range

On selection of the MULTI TARGET BY RANGE display option, up to 6 targets are listed in order of their range from own ship (closest range at the top of the list) as shown in the example on the left.

TARGET (USER)		
ID	TCPA MINS	CPA NM
03	5.7	7.2
01	-3.2	4.8
--	--.-	--.-
--	--.-	--.-
--	--.-	--.-
--	--.-	--.-

Viewing up to 6 User Selected Targets

On selection of the MULTI TARGET (USER) display option, up to 6 user selected targets are listed as shown in the example on the left. To include a target in the list, left click on an acquired target in the video circle. To remove a target from the list, right click on that target in the **list**.

```
TARGET xnn/name  
MMSI      00000007  
CALL SIGN xxxxxxxx  
NAME  
DESTINATION  
TYPE      Passenger  
HEADING   040°  
POSN ACC <10m (RAIM)  
          Underway
```

AIS Information Display (Option)

On selection of the AIS INFORMATION display option, the AIS information received for that target is displayed, as shown, if it is an AIS target. If the target is not an AIS target a brief explanatory prompt is displayed.

The target, for which data is shown, can be changed by left clicking on a different activated target in the video circle. A left click on the selected target in the video circle will toggle between the AIS information tote and the target tote.

The information displayed is as follows:

MMSI – the Maritime Mobile Service Identity number
Vessel Call Sign, name and destination
Vessel Type, heading and status (eg underway or moored)
The positional accuracy of the information will be either <10m or >10m. RAIM (Receiver Autonomous Integrity Monitoring) will be appended if in use.

There is a possibility of positional error, if a datum other than WGS84 is being used by the transmitter or by own ship.

Intentionally Blank

CHAPTER 8

Target Functions

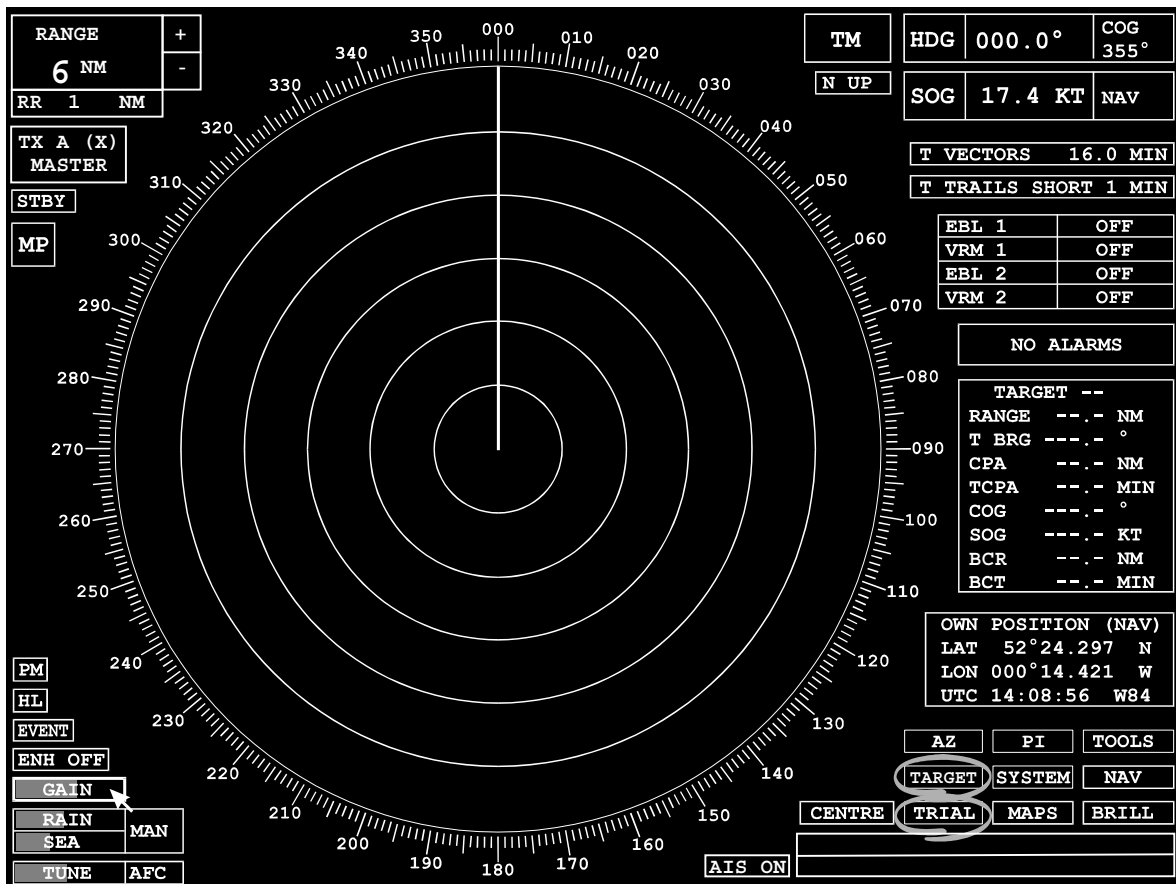

Covered in this chapter:

- Allocating names to acquired targets.
- Displaying target IDs and names in the video circle.
- Automatically dropping targets which are not a danger to own ship or which move beyond a fixed limit behind own ship.
- Displaying dots to indicate the past positions for all acquired targets.
- Outputting data on tracked targets.
- Target repair.
- Trial Manoeuvres.
- AIS features.



Introduction

A number of additional target functions are provided depending on whether the radar is configured as an ARPA (Automatic Radar Plotting Aid), an ATA (Automatic Tracking Aid) or an EPA (Electronic Plotting Aid). These functions are accessed from the **TARGET** soft key. The example on the left shows the **TARGET** soft key, but may be replaced by ARPA, ATA or EPA, dependant on the configuration and software version.

Accessing TARGET Functions

Note – Although the following procedure is given for the ARPA, it is exactly the same for the ATA and the EPA except that their associated menus will have fewer options available. From version 4.08 software the word TARGET replaces the word ARPA, ATA or EPA on soft keys and menus.



1. Position the screen cursor over the **TARGET** or **EPA** soft key.
2. Right click to toggle TARGET DISPLAY **ON** or **OFF**.

Note – When the DISPLAY function is turned-ON, only the options currently ON in the TARGET menu will be visible. When turned-OFF all TARGET related synthetics are removed from the radar picture.

TARGET Menu

A left click will reveal either the **TARGET** menu or the **EPA** menu as shown.

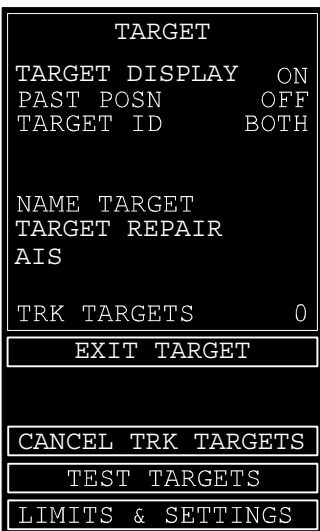

A left click on the **EXIT TARGET** or **EXIT EPA** soft key will close the menu.

Turning the Display of TARGET Data ON or OFF

1. Within the menu, position the screen cursor over the **TARGET DISPLAY** or **EPA DATA** line.
2. Left click to toggle the target display ON or OFF.

Both AIS and auto track Target data is only displayed on the 0.5NM range and above when in transmit.

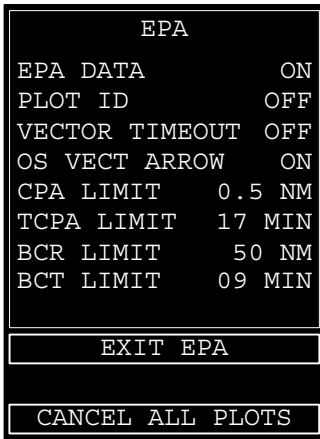

EPA(L) Menu

The EPA(L) menu combines the limits and settings menu with the EPA menu, as shown. Refer to Limits & Settings menu later in this chapter for further details on VECTOR TIME OUT, OS VECT ARROW and setting the CPA, TCPA, BCR and BCT limits.

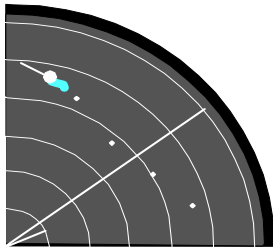

Past Position Dots (ARPA only)

If past position dots are switched on, dots will be displayed indicating the past positions for all targets. The interval between the dots is selected by the user.

As soon as an autotrack target is acquired, or when an AIS target is one of the closest 40, the past position data starts to build up. The number of dots displayed, up to a maximum of 4, is determined by the length of time the target has been tracked and the time interval selected.

Past position dots are available in all presentation and motion modes providing the system has a working compass. Dots always match the trail mode, ie True in RM(T)/TM, and relative in RM(R).



To Turn the Past Position Dots ON or OFF

1. Within the menu, position the screen cursor over the **PAST POSN** line.
2. Left click to toggle the display of past position dots ON or OFF. When the past position dots are switched ON, the time interval between dots will be displayed in the menu, and as a permanent prompt at the bottom of the display.

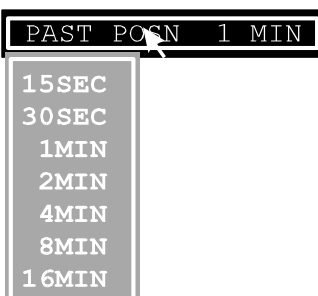

To Select the Past Position Time Interval

1. Within the menu, position the screen cursor over the **PAST POSN** line.
2. Right click to reveal a drop down menu listing the time intervals available.
3. Left click on the time interval required.

Target IDs

This facility enables the operator to select whether target IDs are displayed in the video circle against the associated tracked targets.

To Change Display of Target Names and IDs (ARPA and ATA only)



1. Within the menu, position the screen cursor over the **TARGET ID** line.
2. Left click to toggle through the options available, ie OFF – Number – Name – Both (Number & Name)

Or



1. Within the menu, position the screen cursor over the **TARGET ID** line.
2. Right click to reveal a drop down menu.
3. Left click on the option required.

Note: If Target Rename (VMS) is selected, only OFF or ON (BOTH) will be available. When NAME is selected the number will be displayed if no name has been allocated.

To Change Display of PLOT IDs (EPA only)



1. Within the menu, position the screen cursor over the **PLOT ID** line.
2. Left click to toggle the PLOT IDs ON or OFF.

Naming Targets (ARPA and ATA only)

This facility allows the operator to allocate names to tracked targets. It is not available if Target Rename or Target Rename (VMS) is selected as an Input on Initialisation (see Ships Manual Chapter 4).



1. Left click on the **NAME TARGET** line in the menu to reveal a drop down alpha-numeric keypad in which the target name can be entered – see Chapter 15.
2. After entering a name, select an acquired target by left clicking on a target within the video circle.

Cancel All Plots (EPA only)

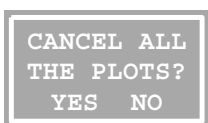

1. Left click on the **CANCEL ALL PLOTS** soft key to reveal the dialog box shown on the left.
2. Left click on YES to cancel all plots and close the dialog box.

A left click on NO will close the dialog box without canceling any plots.

Cancelling All Tracked Targets (ARPA and ATA only)



1. Left click on the **CANCEL TRK TARGETS** soft key to reveal the dialog box shown on the left.
 2. Left click on YES to cancel all the tracked targets and close the dialog box. (AIS targets are unaffected).
- A left click on NO will close the dialog box without canceling any targets.

Targets Currently Being Tracked (ARPA and ATA only)

The **TRK TARGETS** line in the menu indicates the number of targets currently being tracked.

Target Repair (ARPA & ATA only)

The target repair facility is provided to allow the repositioning of tracked (not AIS) target synthetics, in the event that they get separated from the target video due to mis-tracking. The following information associated with the target remains unaffected:-

- Target ID number
- Target name
- Existing Past Position dots
- Velocity

To Select Target Repair



1. Within the menu, position the screen cursor over the **TARGET REPAIR** text.
2. Left click to select. If not already on, the autotrack display will switch on.
3. Use the cursor to drag the required target vector to its correct position, and release. A right click will abort the repair.

Appropriate prompts will be displayed in the following conditions:-

- When a repair has been effected
- If an attempt is made to repair an echo reference target
- If an attempt is made to locate, the new target position outside the tracking range limits



AIS Menu (Option)

If the system has the AIS option enabled then the **TARGET** menu will also display an AIS line.

A left click on the **AIS** line in the **TARGET** menu will reveal the **AIS** menu as shown.

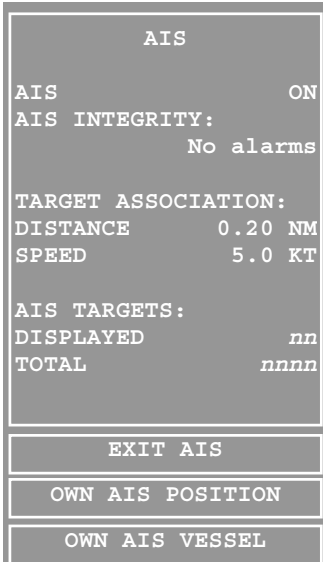

This menu allows the operator to view the AIS information of own vessel, the parameters associated with target association, the status of the AIS integrity alarm and the AIS target totals.

A left click on the **EXIT AIS** soft key will close the menu.

Turning AIS feature ON and OFF

1. Position the screen cursor over the AIS line in the AIS menu.
2. Left click to display a warning box.
3. Left click on YES in the dialog box to toggle AIS ON or OFF.

Turning the AIS feature ON will use the AIS information that is being received, and replace any autotrack target information for targets that match the association parameters.

Turning the AIS feature OFF will initiate autotrack target acquisition for any activated target, or a target used in the tote or for track history. However the maximum of 40 autotrack targets will still apply.

Whenever the source data for a target is changed, target manoeuvres may be observed.

AIS Integrity

The AIS Integrity line will indicate if there are any alarm messages being received. If there is one, then the alarm text will be displayed in the menu and an **AIS INTEGRITY** alarm raised. If there are no alarms then **NO ALARMS** will be displayed in the menu.

Target Association

When a new AIS target is to be displayed, the system will check to associate it with an existing autotrack target. First it checks the distance association and then the speed. If it does associate then the characteristics and history of that target will be transferred to the AIS target, and the autotrack target will be cancelled. The association characteristics are displayed in the AIS menu.

Changing the Target Association values

1. Position the screen cursor over the parameter to be changed
2. Left click to access
3. Move the cursor control left or right to change the parameter
4. Left click to accept

Alternatively a right click will reveal a drop down numeric keypad from which the parameter value can be entered, see Chapter 15.

Values can be set and stored between 0.01 and 1.0 NM for distance, and between 0.1 and 10.0 KTS for speed. The target has to meet both criteria to be associated.

AIS Target Totals

The displayed AIS targets line will show the number of AIS targets that can be shown on the screen.

The shaded area under the 'AIS ON' caption also represents this number. The total AIS targets line will show the number of different vessels from which AIS messages are being received and filtered for display.

```
OWN AIS POSITION

LAT      nn°nn.nnn N
LON      nnn°nn.nnn E

HEADING   nnn°
COG       nnn.n°
SOG       nnn.n KT

NAV STATUS:
          Underway

EXIT OWN POSITION
```

Own AIS POSITION Menu

A left click on the **OWN AIS POSITION** soft key will display the following read-only menu, containing the information sent out from the AIS.

```
OWN AIS VESSEL

MMSI      nnnnnnnnn
CLASS     x

TYPE      xxxxxxxxxxx
IMO NUM   nnnnnnnnn
CALL SIGN xxxxxxxx

NAME:
          Own ship name
DESTINATION:
          Destination

EXIT OWN VESSEL
```

Own AIS VESSEL Menu

A left click on the **OWN AIS VESSEL** soft key will display the following read-only menu, containing the information sent out from the AIS.

Test Targets (ARPA and ATA only)

Two user definable test targets are available in all presentation and motion modes, provided the system has a working compass and is in transmit. These targets can be acquired and tracked in exactly the same way as real targets. Each target is assigned with its own default parameters.

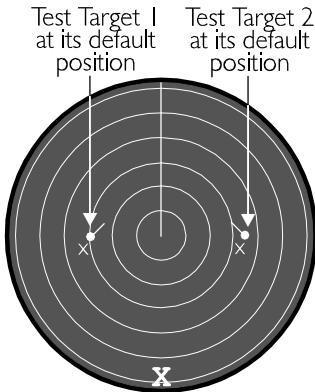

TEST TARGETS

TEST TARGETS	
TARGET 1	OFF
RANGE	5.0NM
R BRG	270.0°
STW	15.0KT
CSE	045.0°
TARGET 2	OFF
RANGE	4.0NM
R BRG	090.0°
STW	15.0KT
CSE	315.0°
EXIT TEST TARGETS	

TARGET 1 OFF

Selecting Test Target Mode

1. Position the screen cursor over the **TEST TARGETS** soft key located under the **TARGET** menu.
2. Left click to reveal the **TEST TARGETS** menu shown on the left.

A left click on the **EXIT TEST TARGETS** soft key will close the menu. It will not delete the Test Targets.

Switching Each Test Target ON and OFF

1. Position the screen cursor over the **TARGET 1** or **TARGET 2** line in the menu.
2. Left click to toggle that test target ON or OFF.
When either test target is switched on, a flashing letter 'x' is displayed at the bottom of the video circle. Additionally, a small flashing letter 'x' appears by the test target.

HAS TEST
TARGET BEEN
CANCELLED?
ACCEPT

Note – On turning-off a test target, a dialog box appears reminding the operator to cancel test target tracking. This will prevent a 'Lost target' alarm being raised. Left click on the **Accept** caption to clear the dialog box.

Changing Test Target Parameters

Before switching a test target ON, its initial range, bearing, speed and course can be defined by the operator. Once a target is ON, only its speed and course can be changed.

1. Position the screen cursor over the parameter to be changed.
2. Left click to access.
3. Move the cursor control left or right to change the parameter value, see Note below.
4. Left click to accept

Alternatively a right click will reveal a drop down numeric keypad from which the parameter value can be entered, see Chapter 15.

Note – Speed can be set from 0 to 75 kt inclusive; Range can be set from 0.3 to 40.0 nm inclusive.

Limits & Settings Menu

The LIMITS & SETTINGS menu provides the means of selecting additional features (Autodrop, Vector Timeout and OS Vector Arrow), and for setting the CPA, TCPA, BCR and BCT limits.

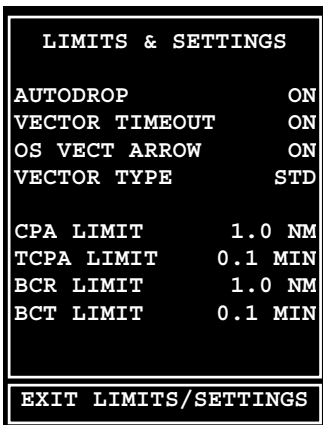

1. Position the screen cursor over the **LIMITS & SETTINGS** soft key located under the TARGET menu.
2. Left click to reveal the LIMITS & SETTINGS menu shown on the left.

A left click on the **EXIT LIMITS/SETTINGS** soft key will close the menu.

Automatic Dropping of Targets (ARPA and ATA only)

If Autodrop mode is switched on, autotrack targets which are not a danger to own ship are automatically dropped without any alarm being raised. Any autotrack target, whether it was acquired manually or automatically, will be dropped if it meets all of the following criteria,

- The target is not in an auto-acquisition zone
- It is not the echo reference target
- It doesn't have a CPA/TCPA or Bow Crossing alarm raised against it

- The TCPA is more than 3 minutes ago
- The target is astern of own ship
- Its range is more than 10 nm from own ship

Regardless of whether Autodrop mode is ON or OFF, all targets will be dropped when the radar is switched to standby. Also, any target which meets any of the following criteria will be automatically dropped.

- Its range is more than 40 nm from own ship
- Valid plot data has not been obtained for the last 60 radar scans, ie the target has been lost and a **LOST TARGET** alarm already been raised.

Autodrop (ATA and ARPA only)



The Autodrop facility is selected (ON or OFF) by a left click on the AUTODROP line in the menu. Access to this facility requires the input of the Navigator's password.

Vector Timeout

If the selected vector mode does not match the current motion mode (see Chapter 5), the vector data is displayed in orange. If Vector Timeout has been selected (ON) using the procedure below, then the vector mode will revert to the same as the motion mode after 30 seconds.



To Turn Vector Timeout ON or OFF

1. Within the menu, position the screen cursor over the **VECTOR TIMEOUT** text.
2. Left click to toggle ON or OFF.

OS Vector Arrow

This option allows the user to display an arrowhead on own ship's vector. A single arrowhead represents course and speed through the water (STW), and a double arrowhead represents course and speed over the ground (SOG).



To Turn OS Vector Arrow ON or OFF

1. Within the menu, position the screen cursor over the **OS VECT ARROW** text.
2. Left click to toggle ON or OFF.



VECTOR TYPE STD

Vector Type

From version 5.0 software the type of vector display for non AIS enabled sets can be set as STD (solid lines default) or AIS (dashed lines).

Access to this facility requires the input of the Navigators password.

To Switch Vector Types

1. Within the menu position the screen cursor over the VECTOR TYPE text.
2. Left click to toggle between AIS and STD.

Note – This feature also makes the selected target symbol dashed or solid as set.

CPA, TCPA, BCR and BCT Limits

The alarm limits for 'Closest point of approach to own ship' (**CPA**) and 'Time to CPA' (**TCPA**), and for 'Bow crossing range' (**BCR**) and 'Bow crossing time' (**BCT**) can be set and stored in the following manner.



CPA LIMIT	4.3 NM
TCPA LIMIT	09 MIN
BCR LIMIT	2.0 NM
BCT LIMIT	05 MIN

1. Within the LIMITS & SETTINGS menu, position the screen cursor over the line of the limit that is to be changed.
2. Left click to access. The selected line will be highlighted in yellow.
3. Move the cursor control left or right to change the limit setting.
4. Left click to accept the new limit.

Alternatively, a right click on a limit line in the menu will reveal a drop down keypad from where the required limit can be entered, refer to Chapter 15.

Note – These limits can also be set from the Target Tote menu.

Trial Manoeuvres (ARPA only)

Note – This option will only be available on a system which is configured as an ARPA.

A trial manoeuvre can be carried out to see the effect of a proposed manoeuvre of own ship.

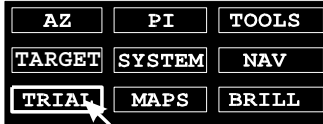

1. Position the screen cursor over the TRIAL soft key.
2. Left click to reveal the TRIAL MANOEUVRE menu shown in the example left.

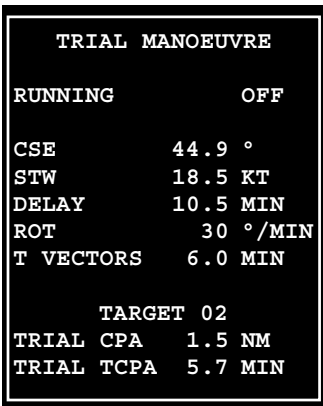

Note – Own ship's course and speed are used as the default settings in the Trial Manoeuvre menu. A right click at any time will exit the facility and remove the menu.

Running a Trial Manoeuvre

Final Course of Own Ship

Enter the proposed course of own ship to be followed after the manoeuvre.

1. Left click on the COURSE line (CSE or COG) to activate.
2. Move the cursor control left or right to set the course required.
3. Left click to accept.

Speed of Manoeuvre

If you intend to change speed, enter the proposed speed of own ship to be maintained during and after the manoeuvre.

1. Left click on the SPEED line (STW or SOG) to activate.
2. Move the cursor control left or right to set the required speed.
3. Left click to accept.

Manoeuvre Delay

Enter the proposed time delay between switching the trial manoeuvre ON and actually starting the manoeuvre.

1. Left click on the DELAY line to activate.
2. Move the cursor control left or right to set the required delay.
3. Left click to accept.

Rate of Turn

From version 5.01 software it is possible to enter the proposed Rate Of Turn (ROT) to be maintained during the manoeuvre.

1. Left click on the ROT line to activate.
2. Move the cursor control left or right to set the required ROT.
3. Left click to accept.

Note – This ROT can be set differently to the standard ROT set during initialisation. Before 5.01 software the standard ROT was always used for the manoeuvre.

Vector Type

Select TRUE or REL (Relative) vector type as follows,

1. Position the screen cursor over the vector type selection field in the Trial Manoeuvre menu.
2. Consecutive left clicks will toggle the type between TRUE (T) and RELATIVE (R) VECTORS.



Vector Time

Enter the proposed vector time.

1. Position the screen cursor over the vector time field in the Trial Manoeuvre menu.
2. Left click to access.
3. Move the cursor control left or right to change the time.
4. Left click to accept.



Note – Entering a longer vector time will allow you to see further into the trial manoeuvre. The above procedures (for Vector Type and Vector Time) will overwrite any selections made earlier (see Vector Mode in Chapter 5) and will remain in force until changed. If required, reset the vector time after the trial manoeuvre is completed.

Trial CPA/TCPA

From version 5.01 software it is possible to view the effect the trial manoeuvre has on the CPA/TCPA of the tote target. This data is shown at the bottom of the TRIAL MANOEUVRE menu. The data in the tote menu is unaffected by the trial manoeuvre.

Manoeuvre Switch-ON

Left click on the RUNNING line to switch the manoeuvre ON. The 'manoeuvre delay' entered earlier will start to count down.

The manoeuvre vectors are displayed until the delay time for the manoeuvre reaches zero, or the manoeuvre is switched-OFF. (When the manoeuvre is running, a left click on the RUNNING line will switch-OFF the manoeuvre.)

The trial manoeuvre vectors are displayed when the trial manoeuvre is running and the dialog box is displayed. If the dialog box is exited while the manoeuvre is running the manoeuvre continues to run, even though the trial vectors are not displayed.

The manoeuvre's speed, course, delay, rate of turn, vector type and length can be changed at any time during the trial.

If true (T) vectors are selected, the trial vector is shown for own ship only, as shown in the example below. This shows own ship's true course during the manoeuvre. The Rate of Turn and the manoeuvre speed determine the radius of the turn. Effects due to tidal stream and leeway are not taken into account

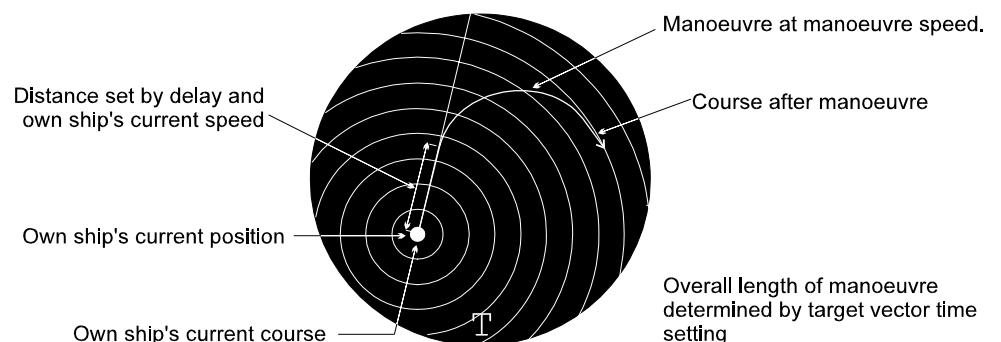

If relative (R) vectors are selected, the trial vectors are applied to every acquired or activated AIS target, with own ship's vector suppressed, and show the course and speed of the targets relative to own ship. The effects on the targets trial vector due to tidal stream, leeway are not taken into account when calculating the relative vectors.

From version 5.01 software onwards, the trial relative vectors will be drawn as three lines. The first part of the vector represents the vector before the manoeuvre. The third part of the vector represents the situation after the trial manoeuvre has completed. These two parts are joined by a straight line, (the second part of the vector) which represents the complex manoeuvre between own ship and the relative target. The third part of the vector will always be at the correct relative angle, but its position is very dependent on own ships rate of turn and speed during the manoeuvre.

Therefore these relative vectors should only be used for planning. The normal (non-trial) vectors should be used for collision avoidance.

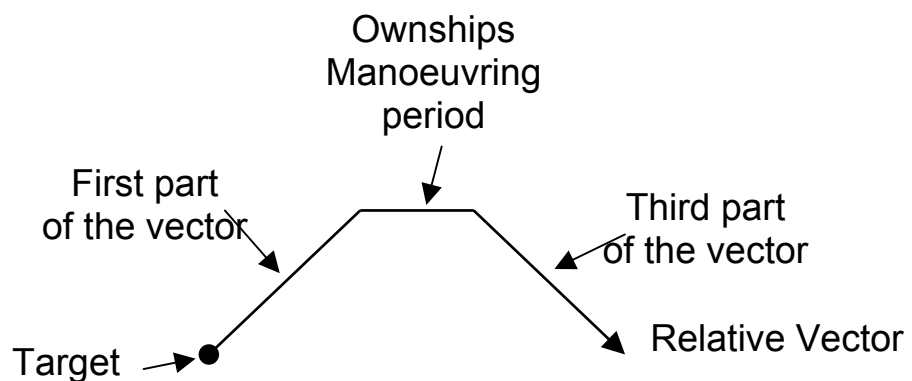

Manoeuvre Time

While the trial manoeuvre is running and the Trial Manoeuvre Menu is displayed, the letter 'T' will appear flashing at the bottom of the video circle. Once the delay reaches zero, the 'T' is removed from the display and the manoeuvre is turned OFF.

Note – A MVR TIME alarm is raised 30 seconds before the manoeuvre is turned OFF.

CHAPTER Navigation 9

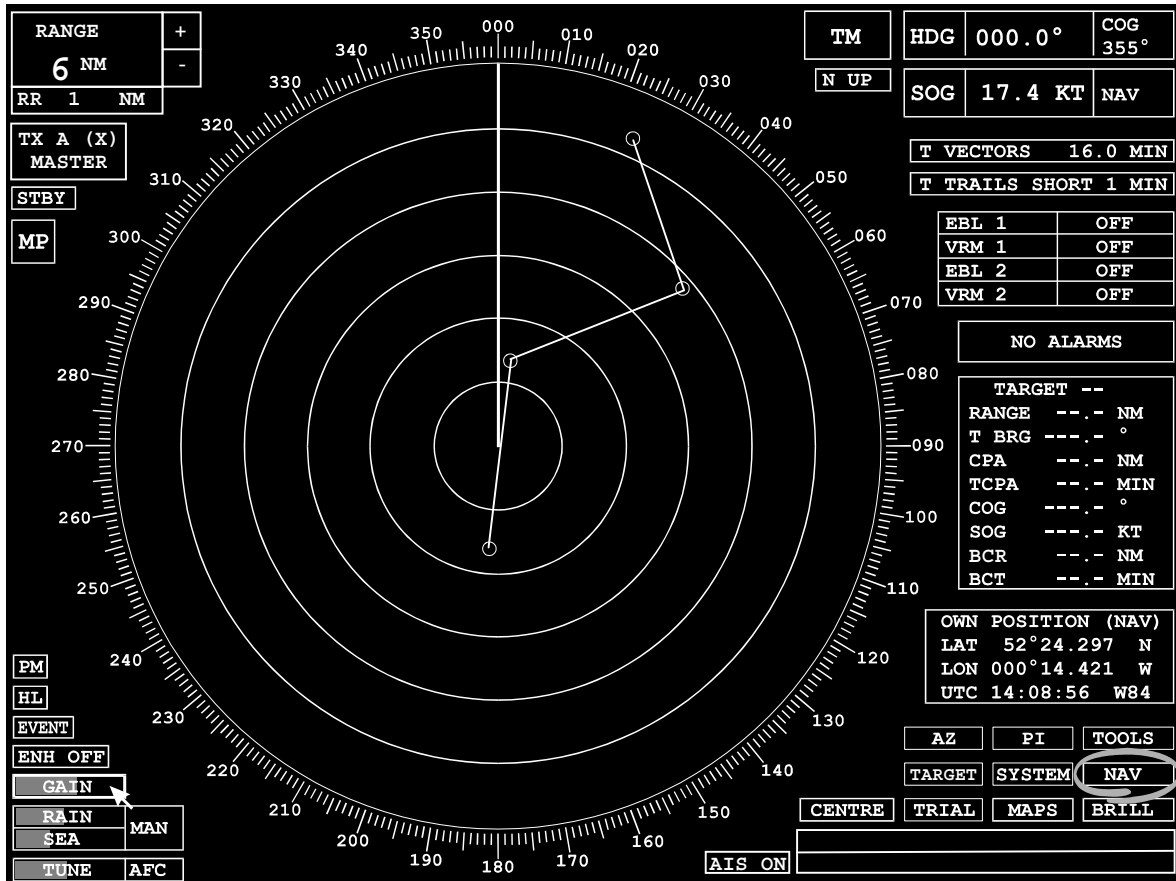

Covered in this chapter:

- Selecting the method used to derive own ship's position.
- Generating and displaying route data to allow own ship to follow a pre-defined route.
- Displaying a route.
- Recording and replaying data on the positions of own ship and tracked targets.
- Synchronising the system's internal clock with UTC or local time.
- Setting the cursor data display type.



Introduction

The navigation (NAV) soft key provides access to the NAVIGATION menu and the facilities for;

- Defining own ship's position
- Setting cursor data display
- Switching route display ON and OFF
- Recording and playback of tracks
- Setting system time and date
- Displaying route data
- Displaying waypoint data
- Generating internal routes*
- Route and waypoint transfer*
- Editing position database*

**Note – From version 4.08 software, a new facility has been added to ARPA's enabling the direct input of route data. This has produced a new version of the menu as below, whilst the soft keys have the same function, they are now located in different positions.*

Important Note – The new facility of internal routes is to be used as an indication of progress along a route only (similar to a GPS receiver), routes should always be planned on ECDIS or paper charts so that all depth, contour and dangers are evident to the navigator.

Turning the Navigation Display ON and OFF



1. Position the screen cursor over the NAV soft key.
2. Right click to toggle the display of routes, waypoints and track history ON or OFF.

Note – When ON, only the navigation features which were previously turned ON from within the NAVIGATION menu are displayed. See NAVIGATION menu below.

Accessing the NAVIGATION Menu

1. Position the screen cursor over the NAV soft key.
2. Left click to reveal the NAVIGATION menu shown on the left.

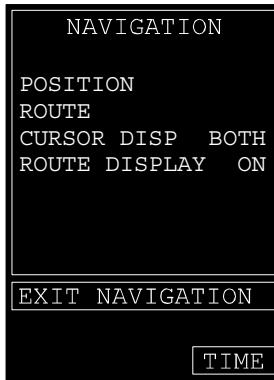

There are two variants of this menu, as shown.

A left click on the EXIT NAVIGATION soft key will close the menu.

Separate soft keys or menu lines are provided for access to TIME, TRACK HISTORY, POSITION and ROUTE menus.

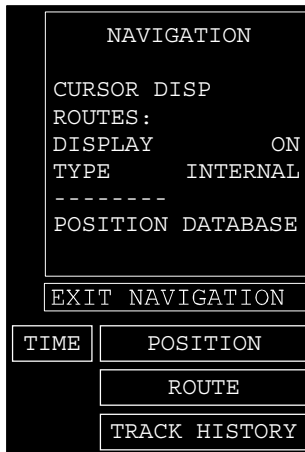

The TYPE and POSITION DATABASE lines are only available on an ARPA system with at least version 4.08 software.

The TRACK HISTORY soft key is not available on EPA.



Track History (ARPA and ATA only)

The TRACK HISTORY facility is accessed from the TRACK HISTORY soft key, which is displayed below the NAVIGATION menu. This allows the positions of own ship and up to six targets to be recorded. Recorded data can be replayed in either standby or transmit at a later date. Data cannot be recorded and replayed at the same time.

Track history can be recorded irrespective of motion mode or presentation mode, provided that a valid heading and own ship's position are available.

Track history can only be displayed (and replayed) on range scales of 0.5NM and above.

Track history, for each target and own ship, comprises three types of data as follows;

Track Segments

These are straight lines drawn between recorded time mark positions. They are dotted for targets, and solid for own ship. Each time a target or own ship travels for a user specified time, its new lat/long position is recorded, and an additional track segment is added to the track history display. Data is recorded using WGS84 datum.

Time Marks

Data is recorded at fixed time intervals. The recording interval defaults to 1 minute but can be defined by the user (1, 3, 6, 12, 30 or 60 minutes). Data is recorded for each target and own ship at each time mark. The data is also time tagged in UTC or local time depending on which is in current use. Time marks are displayed at multiples of 20 time intervals. See **Setting System Time and Date** later in the chapter.

Event Marks

The lat/lon positions of each target and own ship are recorded and time tagged on operator request.

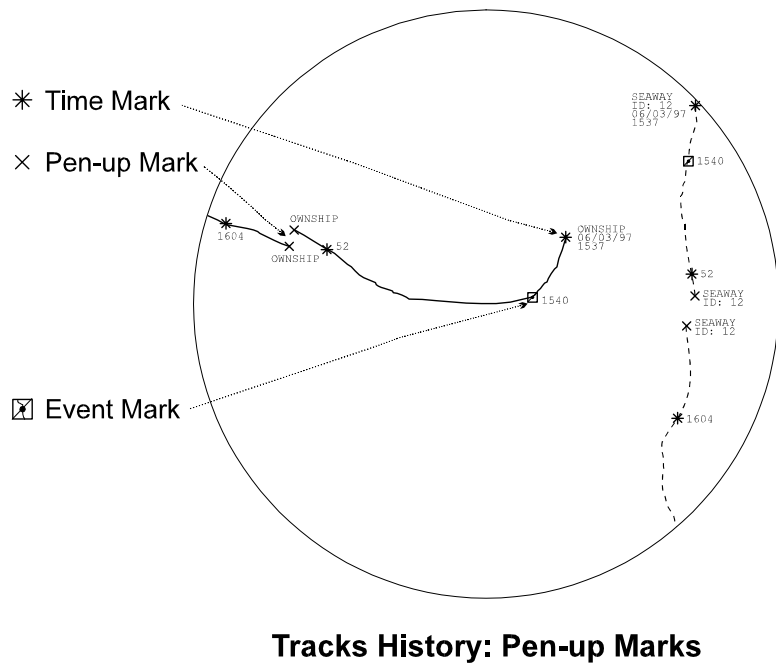
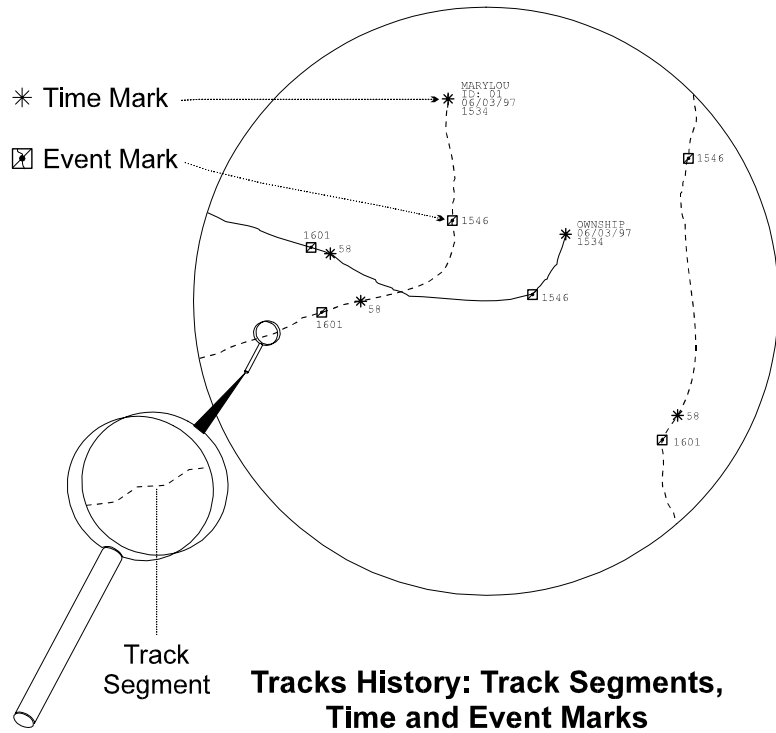

Track history is built up of a series of short **Track Segments**. These are always straight lines which start and finish at recorded positions.

Time Marks are displayed as asterisks after every 20 recorded positions with the time of the fix shown nearby. The time is given in hours and minutes for the first fix, and for the first fix after each hour. Otherwise, it is given in minutes only. The date is shown at the start of the track and against a time mark when midnight is passed. **Event Marks** are shown as a small box with the position and time displayed nearby. If the system detects a significant jump in consecutive segment positions, a **Pen-up** symbol is displayed at the end of each segment.

TRACK HISTORY

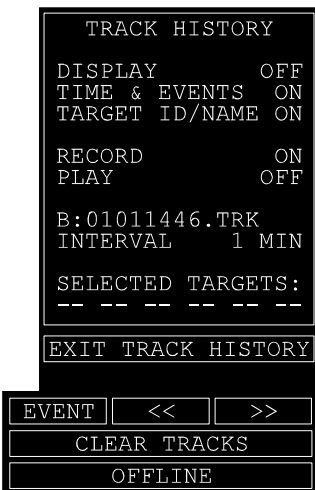

Accessing the TRACK HISTORY Menu

1. Position the screen cursor over the TRACK HISTORY soft key below the NAVIGATION menu.
2. Left click to reveal the TRACK HISTORY menu shown on the left.

A left click on the EXIT TRACK HISTORY soft key will close the TRACK HISTORY menu and return to the NAVIGATION menu.



Display of Track History Data

The track history components can be selectively displayed or turned off by left clicking on the DISPLAY, TIME & EVENTS and TARGET ID/NAME lines in the menu.

Setting the DISPLAY line to OFF will remove ALL track history components from the screen.

If the DISPLAY line is set to ON then the TIME & EVENTS line in the menu can be used to toggle ON and OFF the TIME & EVENTS data.

If the DISPLAY line is set to ON then the TARGET ID/NAMES line in the menu can be used to toggle ON and OFF the ID/NAME data.

Starting/Stopping a Recording

At least one memory card must be inserted and not have its 'write protect' switched on. The file name is allocated automatically by the system, see **Filenames** on next page.



1. Position the screen cursor over the RECORD line in the TRACK HISTORY menu.
2. Left click to toggle record ON (start recording) or OFF (stop recording).

Record-ON cannot be selected while an earlier track history is being played.



If two memory cards are present, the dialog box shown is displayed. Left click on the appropriate caption to proceed.

Filenames

Filenames are allocated automatically by the system and consist of the current date and time with a fixed extension of .TRK being added. The full filename will therefore be of the form 'mmddhhmm.TRK' which, reading from left to right, relates to month (*mm*), day (*dd*), hours (*hh*) and minutes (*mm*), eg 06152035 for June 15th at 8.35hrs in the evening.

Note – Files can be renamed after recording, using the SYSTEM menu, selecting MEMORY CARD and then RENAME FILE, see Chapter 14.

Setting the Time Interval

To set the time interval for time mark recording,



1. Position the screen cursor over the INTERVAL line in the TRACK HISTORY menu.
2. Left click to select. The interval time will be highlighted in yellow.
3. Move the cursor control left or right to select the interval time required. The time intervals available are 1, 3, 6, 12, 30 or 60 minutes.
4. Left click to accept the new interval time.



Alternatively a right click on the INTERVAL line will reveal a drop down menu containing a list of the intervals available. Left click on the time required.

Selecting Targets for History Tracking

Note – Own ship is automatically tracked and doesn't need to be selected. Targets selected must be already being tracked, or be an AIS target.



1. Position the screen cursor anywhere over the bottom two lines in the TRACK HISTORY menu.
2. Left click to select.
3. Within the video circle, left click on a target to select it for history tracking. The selected target's No will replace a pair of dashes in the bottom line of the menu.

Note – Target numbers are ordered numerically starting at the left of the dashed line.

Steps 2 and 3 can be repeated to select up to six targets.
4. Left click anywhere over the bottom two lines to end selection.



Deselecting Targets from History Tracking

1. Position the screen cursor anywhere over the bottom two lines in the TRACK HISTORY menu.
2. Left click to select.
3. Within the video circle, right click on the target to deselect it from history tracking. The selected target's number will be removed from the bottom line of the menu.
4. Left click anywhere over the bottom two lines to end selection.



Alternatively, a right click anywhere on the bottom two lines in the TRACK HISTORY menu will reveal a drop down menu containing a list of the selected targets. Left click on the target to be deselected (or on the REMOVE ALL option), or right click to close menu.

Event Recording

The recording of an event can be actioned from either of the EVENT soft keys (the one in the bottom left corner of the TRANSMIT display, or the one under the TRACK HISTORY menu). These keys are only active if tracks (own ship/target) are currently being recorded.



1. Position the screen cursor over either of the EVENT soft keys.
2. Left click to record. This will place an event marker and time on own ship and all tracks currently being recorded.  1640

Removing Current Track from Display

This operation is only applicable when recording. It allows unwanted data to be permanently removed from display.



1. Position the screen cursor over the CLEAR TRACKS soft key beneath the TRACK HISTORY menu.
2. Left click to remove all current tracks from the display. The track history will then start to build up again in real time, as before.

Note – The data will only be removed from the screen not from the memory card.

Replaying a Recorded Track

A track history can be displayed in TRANSMIT mode providing its lat/long is close to the current lat/long position. Alternatively, it can be displayed in STANDBY mode. To select a recorded track history file for replay, in either STANDBY or TRANSMIT mode, use the following procedure.

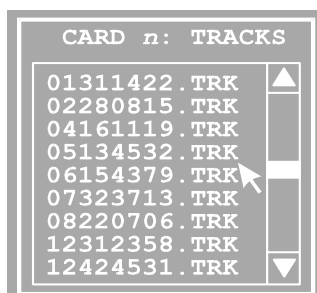

1. Position the screen cursor over the PLAY line in the TRACK HISTORY menu. Play-ON cannot be selected while a track history is being recorded.
2. Left click to reveal the drop down menu shown on the left.
3. If required, left click on the CARD *n*: caption to select memory CARD A or CARD B.
4. Scroll the list if necessary. Left click on the track required to start the replay.

A warning prompt will be displayed if an invalid range scale or an unstabilised presentation mode is in operation. A warning prompt is permanently displayed while the replay is in progress.

Track history is in replay mode

Off Line Centre (Standby Mode)

If in STANDBY mode, the CENTRE LAT/LONG POSITION must be set, in order for the track history to be viewed. This is achieved via the OFFLINE CENTRE menu as follows.

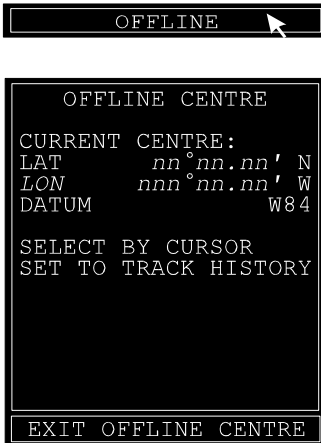

1. Position the screen cursor over the OFFLINE soft key located below the TRACK HISTORY menu.
2. Left click to reveal the OFFLINE CENTRE menu shown left.
3. Left click on the SET TO TRACK HISTORY line in the menu. This will set own ship's initial position (from the track history) to be at the centre of the video circle.

Note – The SET TO TRACK HISTORY line only appears if PLAY is set to ON.

4. Any point in the video circle can be centred by left clicking, first on the SELECT BY CURSOR line in the menu, and then on the required point in the video circle.

Alternatively, a lat/long position with its related datum can be manually entered by left clicking on the LAT, LON or DATUM line in the menu.

Note – The cursor position will always be shown in W84 datum regardless of the input datum. Any changes made to the off line centre are saved on power-OFF.

Replaying Large Tracks

When replaying large track files (too large to be displayed all at once in the video circle), use consecutive left clicks on the back (<<) and forward (>>) soft keys, located under the TRACK HISTORY menu, to step through the recording.



If the beginning or end of a track is already displayed, then clicking on the back or forward soft keys (as appropriate) will result in the display of a suitable warning prompt.



Switching the Replay OFF

1. Position the screen cursor over the PLAY line in the TRACK HISTORY menu.
2. Left click to switch replay OFF

Deleting a Track File from a Memory Card

Tracks can only be deleted from a memory card via the SYSTEM menu. Select MEMORY CARD from the SYSTEM menu, see Chapter 14.

Setting System Time and Date

This facility allows the user to synchronise the system's internal clock to the Universal Time Constant (UTC) or Local Time (LOC). UTC is input from an external navigation sensor if the system was suitably configured during commissioning. See Ship's Manual, Chapter 4.

If UTC is available, local time cannot be entered. However, a local time offset can be entered.

Accessing the Time and Date Menu

1. Position the screen cursor over the TIME soft key beneath the NAVIGATION menu.
2. Left click to reveal the TIME AND DATE menu shown on the left.

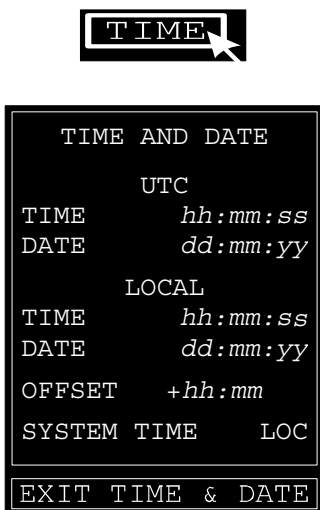

The time mode currently selected is reflected in the SYSTEM TIME line in the menu, LOC or UTC. This is the time displayed in the USER DATA area when it is showing OWN POSITION, see Chapter 3.

A left click on the EXIT TIME & DATE soft key will close the TIME AND DATE menu and return the NAVIGATION menu.

Selecting the Time Mode

1. Position the screen cursor over the SYSTEM TIME line in the TIME AND DATE menu.
2. Left click to toggle between UTC and LOC.



Entering a UTC Date

If UTC is being provided by an external navigation sensor, the time and date (if provided) are indicated in the TIME AND DATE menu. If the navigation sensor is not providing the date, one can be entered as follows.

1. Position the screen cursor over the UTC DATE line in the menu.
2. Left click to reveal a drop down numeric keypad.
3. Use the keypad to enter the date required. See Chapter 15.



Entering a Local Time Offset

Local time cannot be entered when UTC time is available. However, a local time offset can be entered, which will cause local time to be displayed as UTC time plus/minus any offset.



1. Position the screen cursor over the OFFSET caption in the menu.
2. Left click to reveal a drop down numeric keypad.
3. Use the keypad to enter the offset required in hours and minutes. See Chapter 15.

Note – *The offset is remembered on power-off.*

Entering a Local Time and Date

If a UTC input is not configured, both local time and date can be entered.



1. Within the TIME AND DATE menu, position the screen cursor over the LOCAL TIME or LOCAL DATE lines as appropriate.
2. Left click to reveal a drop down numeric keypad.
3. Use the keypad to enter the time or date as required. See Chapter 15.

Note – *OFFSET and SYSTEM TIME selections will not be available if UTC is not configured.*

Position

The Position function allows the method used to derive own ship's position to be selected from one of the following,

- NAV A navigation sensor.
- EP/DR An estimated position or dead reckoning.

Accessing the Position Menu

1. Position the screen cursor over the POSITION soft key under the NAVIGATION menu **or** the POSITION line in the menu.
2. Left click to reveal the POSITION menu shown on the left.

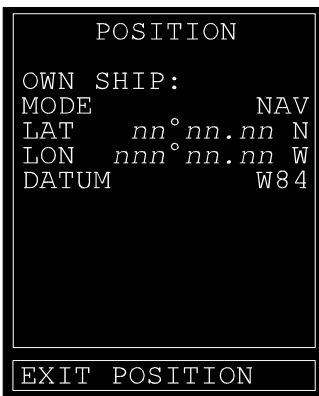

The current position mode is indicated in the MODE line of the menu.

A left click on the EXIT POSITION soft key will close the POSITION menu and return the NAVIGATION menu.

Selecting the Position Mode

1. Position the screen cursor over the MODE line in the POSITION menu.
2. Left click to select the mode required.
Each click will cycle through the available modes. The selected mode will appear in the MODE line of the menu.



A right click on the MODE line will reveal a drop down menu listing the modes available. Left click on the mode required, or right click to close the menu without further action.



A brief description of each mode is given on the next page.

```
POSITION
OWN SHIP:
MODE          NAV
LAT   nn°nn.nn N
LON   nnn°nn.nn W
DATUM          W84
```

Navigation (NAV) Position Mode

When NAV position mode is selected, own ship's position is derived from an external Navigation Sensor. This can be Loran, GPS or Decca. The position is interpreted in W84 (WGS84) datum.

If the sensor input fails (no messages received for 10 seconds or more), a NAV INPUT alarm is raised. If the position is invalid for one minute a POSITION alarm is raised. (See Chapter 13.) The NAV position mode **cannot** be selected if the sensor input has failed.

Own Ship's Position

The co-ordinates for own ship's position, are given in the LAT/LON (own ship) lines of the POSITION menu. The default datum for LAT/LON is W84. If in NAV mode, a nav offset can be applied to compensate for the sensor's position relative to own ship. (See Initialisation menu in Chapter 4 of Ship's Manual).

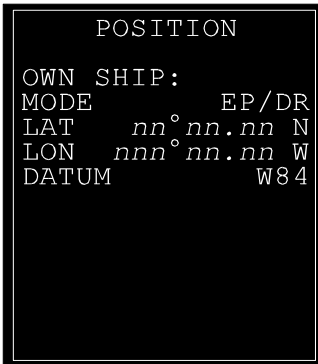

Estimated Position/Dead Reckoning (EP/DR) Mode

When EP/DR mode is selected, the last known value of own ship's position is used but a new lat/lon can be entered. The position is continuously updated by calculating an EP or DR (dead reckoned) position depending on the speed mode in use. EP is used if the speed input is ground locked. If an alarm exists for the selected speed or compass, for more than a minute the derived position will go to dashes, and a POSITION alarm will be raised. EP/DR mode is not available when AIS is in use.

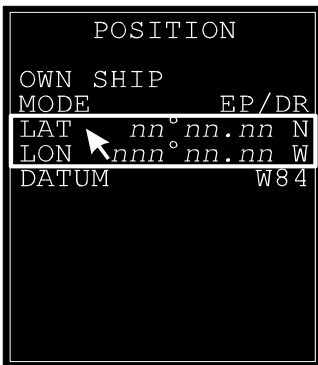

Entering an Estimated Position

The co-ordinates for own ship's position, are given in the LAT/LON (own ship) lines of the POSITION menu. If the position mode selected is EP, an estimated position can be entered as follows:

1. Position the screen cursor over the own ship's LAT/LON lines in the POSITION menu.
2. Left click to reveal a drop down numeric keypad.
3. Use the keypad to enter the EP lat/lon and datum. Selecting datum within the drop down keypad will reveal a list of the datums available. This enables the input of a position in any given datum. See Chapter 15.

Cursor Display

Within the NAVIGATION MENU, the CURSOR DISP line relates to the cursor data displayed when the cursor is within the video circle, see **The On-screen Cursor** in Chapter 2. The information can be displayed in Lat/Lon or Range/Bearing format or in both. If both is selected, 'time to go to cursor position' (**TTG**) is additionally displayed except on SC1.xx and 4.xx versions of software.

TTG always uses the NAV SPEED for this calculation and is dashed out if no nav sensor is fitted.

A screenshot of a menu option labeled 'CURSOR DISP BOTH'. The text is displayed in a dark rectangular box with a white border. A mouse cursor is positioned over the text.

1. Position the screen cursor over the CURSOR DISP line in the NAVIGATION menu.
2. Left click to toggle for BOTH, LAT/LON or RANGE/BRG.

Alternatively, a right click on the CURSOR DISP line will reveal a drop down menu listing the options available. Left click on the option required, or right click to close the menu without further action.

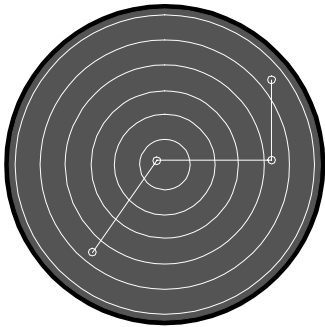

Routes

The ROUTE display is controlled from the NAVIGATION menu. Route data is calculated internally from the internal route data or the route data received from an external source.

Routes can be displayed on all ranges in stabilised modes and when ownships latitude is between 78°N and 78°S.

Route Display

Up to nine legs of a route, consisting of up to ten waypoints, are displayed on the screen at any one time.

Route Legs

Routes can be displayed with rhumb line (RHL) legs or great circle legs (GC). Rhumb lines are drawn as straight lines between waypoints, great circle lines are drawn using an approximation to the great circle curve.

Turning the Route Display ON and OFF

1. Position the screen cursor over the ROUTE DISPLAY or DISPLAY line in the NAVIGATION menu.
2. Left click to toggle the route display ON or OFF.

Note – If H-Up mode is selected when route display is ON, the route display is inhibited until a stabilised mode is selected.

Warning Prompts

If an attempt is made to turn the route display ON when the system is unstabilised in standby, or outside allowed latitudes, an appropriate prompt is displayed.

Select stabilised mode

Invalid latitude

Own ship lat/lon not available

Only available in transmit

ROUTE DISPLAY ON

or

ROUTES :
DISPLAY ON

Route Type

On an ARPA with version 4.08 software or above it is possible to select three types of routes; external, internal, and single leg. On ATA's and EPA's only external routes are available and no TYPE line is displayed.

To select Route Type (ARPA's only)

Either

1. Position the screen cursor over the TYPE line in the NAVIGATION menu.
2. Left click to select the type required. Each click will cycle through the available types. The selected type will appear in the TYPE line of the menu.



Or

1. Position the screen cursor over the TYPE line.
2. Right click to reveal a drop down menu.
3. Within the menu position the screen cursor over the required mode.
4. Left click to select. A right click will close the menu without further action.



Dependent on the route type selection the ROUTE soft key will produce three different menus.

Refer to either EXTERNAL ROUTES, INTERNAL ROUTES or SINGLE LEG ROUTE for details of their functionality.

External Routes

When the route type selected is EXTERNAL the ROUTE soft key functions as follows.

Accessing the EXTERNAL ROUTE Menu

1. Position the screen cursor over the ROUTE soft key under the NAVIGATION menu or the ROUTE line in the menu.
2. Left click to reveal the EXTERNAL ROUTE menus shown on the left.

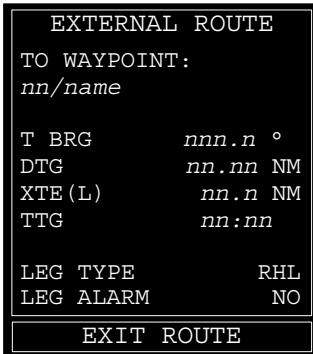

There are two variants of this menu as shown.

A left click on the EXIT ROUTE soft key will close the EXTERNAL ROUTE menu and redisplay the NAVIGATION menu.

Waypoint Data

The first part of the menu will identify the next waypoint number. On software version 4.08 and above its latitude, longitude, datum will also be displayed.

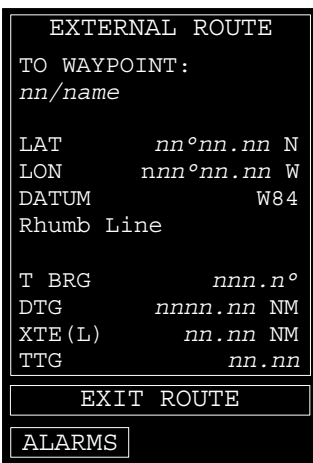

Route Data

The data given in the menu is calculated internally from the route being received and is relative to the next waypoint, and is for indication only. The LEG TYPE defaults to Rhumb Line (RHL); if Great Circle (GC) leg type is required, it must be selected by the user (See Selecting Leg Type later in the chapter). The information displayed is as follows;

- *nn/name* - Identifier of TO WAYPOINT.
- T BRG - True Bearing of NEXT WAYPOINT.
- DTG - Distance To Go to NEXT WAYPOINT.
- XTE (L) or (R) - Cross Track Error, Left or Right.
- TTG - Time To Go to NEXT WAYPOINT.
- LEG TYPE - Rhumb Line (RHL) or Great Circle (GC).
- LEG ALARM - Whether an alarm will be generated on a leg. (EPA(L) only).

Relevant parts of this information can be displayed in the User Data area of the screen if the Waypoint option is selected. See User Specified Data in Chapter 3.

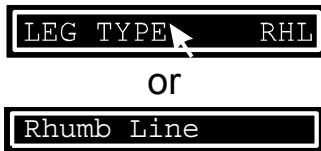

Selecting the LEG TYPE

1. Position the screen cursor over the LEG TYPE line in the EXTERNAL ROUTE menu.
2. Left click to toggle the leg type to Rhumb Line (RHL) or Great Circle (GC). See **ROUTE LEGS** above.

Note – When sailing an external route, the LEG TYPE defaults to ‘rhumb line’ (RHL), after each change of leg. If the route being steered includes ‘great circle’ legs, the user can elect to have an alarm after each change of leg, to prompt the selection of a great circle for the current leg. See Sailing Alarms below.

Sailing Alarms

From the route menu it is possible to select which sailing alarms are required.



Selecting the LEG ALARM (EPA(L) only)

1. Position the screen cursor over the LEG ALARM line in the EXTERNAL ROUTE menu.
2. Left click to toggle the leg alarm to YES (on) or NO (off).



Selecting the SAILING ALARMS menu

Where an ALARMS soft key is available.

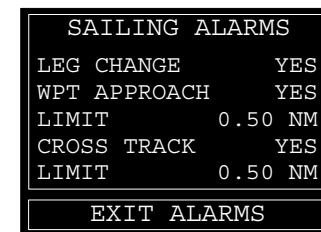

1. Position the screen cursor over the ALARMS soft key under the ROUTE menu.
2. Left click to reveal the SAILING ALARMS menu shown on the left.

Note – A left click on the EXIT ALARMS soft key will close the menu.

LEG change Alarm

If this is set to ON an alarm will be raised on each and every LEG CHANGE.

Changing the alarm settings

The alarm setting for LEG CHANGE, WPT APPROACH or CROSS TRACK can individually be changed.

1. Within the menu position the screen cursor over the alarm you wish to change.
2. Left click to toggle the alarm state to YES(ON) or NO(OFF).

Changing the alarm limits

For waypoint approach and cross track error there are distance limits for when the alarms will be activated.

1. Within the menu position the screen cursor over the limit you wish to change.
2. A left click on the line will allow adjustment using movement of the cursor control.
3. A left click will store the value.

Alternatively a right click will reveal a drop down numeric keypad from where a new limit can be entered. Refer to Chapter 15.

Internal Routes (ARPA only)

When the route type selected is INTERNAL the ROUTE soft key functions as follows.

This feature allows the user to define waypoints and routes directly on the radar display, either by entering lat/long information or positioning the screen cursor.

These routes are stored as files on a memory card. Each route can have 128 entries. An entry consists of a waypoint name and the type of the next leg. Routes are stored as files with the .RTE extension.

The waypoint LAT/LONG positions are stored separately in a file POSITION.POS on the memory card. See POSITION DATABASE later in the chapter.

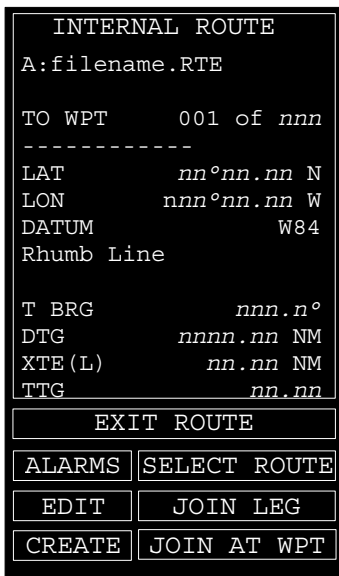

Accessing the INTERNAL ROUTE Menu

1. Position the screen cursor over the ROUTE soft key under the NAVIGATION menu.
2. Left click to reveal the INTERNAL ROUTE menu shown on the left.

A left click on the EXIT ROUTE soft key will close the INTERNAL ROUTE menu and redisplay the NAVIGATION menu.



Selecting an Internal Route from a Memory Card

1. Left click on the SELECT ROUTE soft key under the INTERNAL ROUTE menu to reveal a drop down menu as shown on the left.

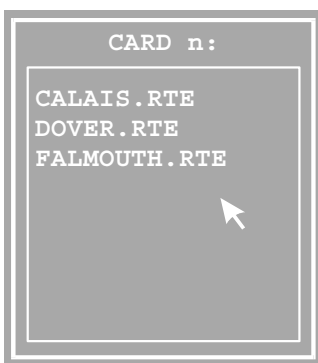

Note: This menu contains a list of filenames for the routes stored on the selected memory card, CARD A or CARD B. The card selected is indicated in the line at the top of the menu. A right click will close the menu with no further action.

2. Position the screen cursor over the CARD n: line, and left click to select the card required.
3. Position the screen cursor over the filename of the route you wish to recall. The file selected will be highlighted.
4. Left key to select.

The INTERNAL ROUTE menu will now be shown with details of its filename and the name and lat/long of the first waypoint in the ROUTE.

The ROUTE will also be displayed on the screen as a series of red circles joined by dashed red lines.

To view details of other waypoints in the route, left click on the TO WPT line and enter the waypoint number.

Sailing on Internal Route

Once a route is selected and you are in transmit you then have the option to join the route at a waypoint or during a leg.

Joining a Route

In transmit two soft keys are displayed for joining a route, depending on whether you want to join at a waypoint or during a leg.



JOIN LEG



JOIN AT WAYPOINT

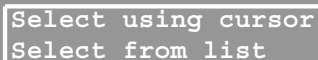

Select using cursor
Select from list

1. Position the screen cursor over either the JOIN LEG or JOIN AT WAYPOINT soft key.
2. Left click to reveal a drop down menu containing two options as shown.
3. Either
 - a) Position the screen cursor over the SELECT USING CURSOR line and left click.
 - b) Move the screen cursor to either the waypoint or the leg where you wish to join the route.
 - c) Left click to select.Or
 - a) Position the screen cursor over the SELECT FROM LIST line and left click.
 - b) A drop down list of waypoints as shown will be display.
 - c) Move the screen cursor to either the waypoint you wish to join at or the waypoint at the end of the leg you wish to join at.
 - d) Left click to select.

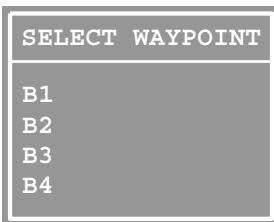

SELECT WAYPOINT

B1
B2
B3
B4

The dashed lines in the route now become solid to indicate the route is now being sailed.

If you selected to join at a waypoint, a route line will be drawn to the waypoint you selected. The menu on display will now show the data of the next waypoint together with its calculated data.

At the bottom of the INTERNAL ROUTE menu, two new soft keys STEP ON and STOP SAILING will be shown.



Actions whilst sailing a Route

Whilst sailing a route, the soft keys will be displayed as shown. See Sailing Alarms for details of the ALARMS soft key.



The STEP ON soft key allows the user to move the 'TO WPT' to the next waypoint in the route.

When selected a dialog box is displayed to confirm the action.



The STOP SAILING soft key allows the user to stop sailing.

When selected a dialog box is displayed to confirm the action.



The EDIT key allows the user to edit the part of the route that has not yet been sailed.

It will not be possible to select any legs before the leg that own ship was sailing.

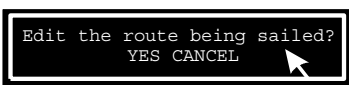

If you select EDIT, a prompt is displayed to confirm that you want to Edit the Route being sailed.

On selecting yes, the EDIT ROUTE menu will be shown and sailing will be suspended.

See Route editing procedures later in the chapter.



Once you have finished editing and exited the EDIT ROUTE menu, the route will automatically be selected and sailed.



Refer to the SAILING ALARMS section for details of the ALARMS soft key.

Creating and Editing Internal Routes

The procedures for creating internal routes, and those for editing internal routes, are very similar. Editing is always for the route currently selected in the menu. See **Selecting an Internal Route from a Memory Card**.

Selecting an Internal Route from a Memory Card

When creating a route the user is initially prompted to enter a **new filename** for the route about to be created. After the new filename has been entered, the remaining procedures for creating a route are the same as those for editing.



Creating an Internal Route

1. Position the screen cursor over the CREATE soft key, under the INTERNAL ROUTE Menu.
2. Left click to reveal a drop down alpha-numeric keypad as shown on the left. Alpha-numeric keypads and their use are described in Chapter 15.
3. Enter the card and filename under which the new map will be saved.
4. When the card and filename is as required, position the screen cursor over the 'carriage return' symbol.
5. Left click to save. This will create the file on the selected memory card under the chosen filename, see notes below.

Notes

1. *If the chosen filename already exists, the name is not accepted, the message 'File already exists' is displayed on the temporary prompt line.*
2. *If the chosen filename is accepted, the **EDIT ROUTE** menu is automatically displayed.*

Editing a Selected Internal Route

Before a route can be edited it must first be selected. See **Selecting an Internal Route from a Memory Card**.

1. Position the screen cursor over the EDIT soft key, under the INTERNAL ROUTE Menu.
2. Left click to reveal the EDIT ROUTE menu shown on the left.



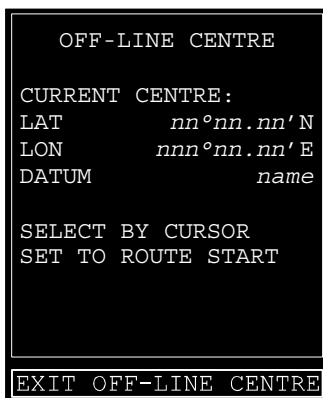
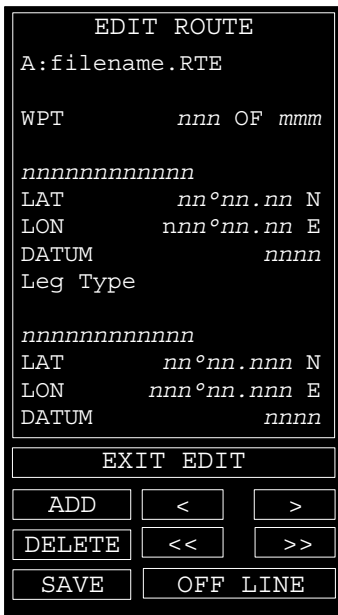

A route can be edited in TRANSMIT mode provided its lat/long is close to the current lat/long position. If this is not the case, the route must be edited in STANDBY mode. In order to do this, the cursor lat/long and range, must be set so that the route can be displayed.

Setting the OFF-LINE CENTRE for Editing in STANDBY Mode

1. Position the screen cursor over the OFF-LINE soft key under the EDIT ROUTE menu.
 2. Left click to reveal the OFF-LINE CENTRE menu shown on the left.
- Note** – The Lat/Long and datum information displayed in the menu defaults to the most recent values set in this mode.
3. If the datum of the lat/long about to be entered (Step 8) is not that displayed in the menu, left click on the DATUM line to reveal a list of the datums available. Left click on the datum required.
 4. Within the menu, left click on the LAT or LONG line to reveal a drop down numeric keypad. Use the keypad to enter the Lat/Long of the selected route.

Additionally, a left click on the SELECT BY CURSOR line causes a + cursor to appear at the centre of the video circle. To change the centre position, left click with the cursor control at the appropriate position. The route will then be re-drawn.

Also a left click on the SET TO ROUTE START line will set the off-line center to be that of the first waypoint in the route and draw the route accordingly.

A left click on the EXIT OFF-LINE CENTRE key will return the system to the EDIT ROUTE menu.

The route can now be edited using the procedure given below.

Route Editing Procedure

A route consists of a string of waypoints in a specific order. The only editing that can be carried out is to add new waypoints into a route or delete them from a route. It is also possible to change the stored data associated with a waypoint from this menu.

When editing a route the information for two waypoints will be displayed. The waypoint at the top of the menu will also be displayed in mauve on the screen with a mauve dotted line joining it to the waypoint at the bottom of the menu.

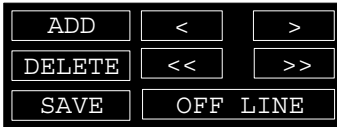

```
Select from database
Enter using cursor
Enter using keypad
```

```
SELECT POSITION
001
002
003
006
007
008
```

```
A B C D E
F G H I J
K L M N O
P Q R S T
U V W X Y
Z _ DEL CLR
1 2 3
4 5 6
7 8 9
< 0 > <|
A:
ENTER WPT NAME
```

Adding a waypoint into a route

1. Position the screen cursor over the ADD soft key.
2. Left click to reveal a drop down menu containing three options.
3. Either
 - a) Position the cursor over the SELECT FROM DATABASE line.
 - b) Left click to reveal a list of waypoint names.
 - c) Move the cursor to the waypoint you wish to add.
 - d) Left click to select

Or

- a) Position the cursor over the ENTER USING CURSOR line.
- b) Left click to reveal a drop down alpha-numeric keypad as shown. See chapter 15 for more information.
- c) Enter the new WAYPOINT NAME at the bottom.
- d) Left click over the carriage return symbol.
- e) Position the screen cursor at the waypoint location required and left click.

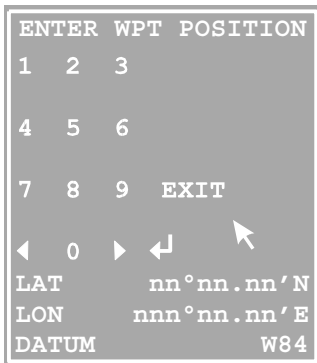

Or

- a) Position the cursor over the ENTER USING KEYPARD line.
- b) Left click to reveal a drop down alpha-numeric keypad as shown. See chapter 15 for more information.
- c) Enter the new WAYPOINT NAME at the bottom.
- d) Left click over the carriage return symbol to reveal an ENTER WPT POSITION numeric keypad as shown.
- e) Use the keypad to enter the required waypoint Lat/Lon position.
- f) Change the datum if required.
- g) Position the cursor over the carriage return symbol and left click to define the waypoint.

When a waypoint is added, it will be added in between the two waypoints in the menu. At the start and end of the route only one waypoint is displayed, and the waypoint can be added before the first waypoint or after the last waypoint.

Displaying the waypoint information as a route

The four arrow keys allow you to display different waypoint information and hence edit different parts of the route.



The double arrows will take you back ten waypoints or forward ten in the route.



The single arrow keys enable you to step back or step on the information displayed one waypoint at a time.

At the start of the route only the TO WAYPOINT data is shown.

At the end of the route only the FROM WAYPOINT data is shown.

Editing the waypoint data from the EDIT ROUTE menu

To edit the LAT/LONG position, or datum of a waypoint, use the following procedure.



LAT nn°nn.nnn'N
LON nnn°nn.nnn'W

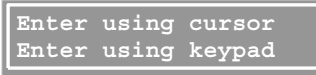

Enter using cursor
Enter using keypad

1. Ensure the waypoint to be changed is the top waypoint on the EDIT ROUTE menu.
2. Position the cursor over the LAT/LON lines.
3. Left click to reveal a drop down menu as shown.
4. Either
 - a) Position the cursor over the ENTER USING CURSOR line and left click.
 - b) The screen cursor will be re-positioned in the center of the video circle and a prompt 'Select a position' will be displayed.
 - c) Use the cursor to select the new position and left click.
 - d) The waypoint will move to the new position and the screen data updated.

Or

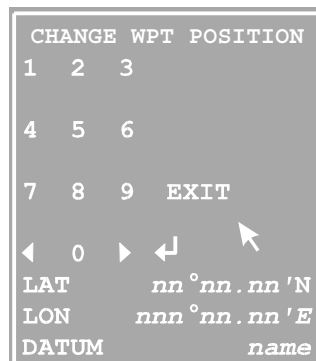

CHANGE WPT POSITION
1 2 3
4 5 6
7 8 9 EXIT
◀ 0 ▶ ↵ ⏪
LAT nn°nn.nnn'N
LON nnn°nn.nnn'E
DATUM name

- a) Position the cursor over the ENTER USING KEYPAD line.
 - b) Left click to reveal a drop down numeric keypad as shown on the left
 - c) Use the keypad to enter the Latitude and Longitude of the waypoint.
 - d) If the datum displayed is incorrect for the lat/long about to be entered, position the cursor over the DATUM caption and left click. This will reveal a list of the datums available. A right click will remove the keypad without further action.
 - e) Left click on the datum associated with the Latitude and Longitude in use.
 - f) Position the cursor over the 'carriage return' symbol ↵ and left click.
5. The waypoint will be re-drawn at the new position and the screen data updated.

Note – This will update the data for that waypoint in the position database for all uses of that waypoint.

Editing the Leg Type

For each leg of an internal route this can be set to Rhumb Line or Great Circle. By default it is set to Rhumb Line.



1. Position the cursor over the leg type line in the EDIT ROUTE menu.
2. Left click to select Great Circle or Rhumb Line.

Deleting a Waypoint from a Route

1. Ensure that the waypoint you wish to delete is the FROM waypoint at the top of the EDIT ROUTE menu.
2. Position the cursor over the DELETE soft key and left click.
3. A confirm delete dialogue box will be displayed.
4. Left click on Yes to confirm delete.



Note – This will not delete the waypoint data from the position database.

Saving a Route

The SAVE soft key allows the user to save a route that is being created or edited to the memory card.



1. Position the cursor over the SAVE soft key.
2. Left click to reveal a drop down alpha-numeric keypad as shown on the left. See chapter 15 for further information.
3. Enter the filename under which the new route will be saved. The original filename will initially be displayed, and this can be overwritten if required.
4. When the filename is as required, position the cursor over the 'carriage return' symbol.
5. Left click to save the route to the memory card.

Note – If an attempt is made to exit from the EDIT ROUTE menu when there are unsaved edits, the user will be prompted, in the form of a dialog box, to save the current edits before exiting.

Exiting the Edit Route

A left click on the EXIT EDIT soft key will close the menu and re-display the INTERNAL ROUTE menu.



Single Leg Routes (ARPA only)

When the route type selected is SINGLE LEG, the ROUTE soft key functions as follows.

This allows the user to define a single waypoint and single leg route on the radar display, either by entering LAT/LONG information, positioning the screen cursor or using an existing waypoint in the POSITION DATABASE on a memory card.

Accessing the SINGLE LEG ROUTE menu

1. Position the screen cursor over the ROUTE soft key, under the NAVIGATION menu.
2. Left click to reveal the SINGLE LEG ROUTE menu shown on the left.

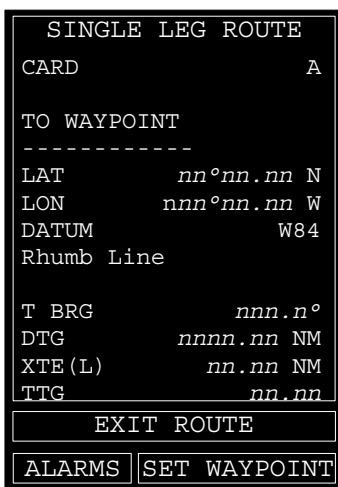

A left click on the EXIT ROUTE soft key will close the SINGLE LEG ROUTE menu and redisplay the NAVIGATION menu.

A left click on the CARD line will switch between the two memory cards, A and B, for accessing and storing waypoints in the POSITION DATABASE.

Refer to the SAILING ALARMS section for details of the ALARMS soft key.

Setting the Single Leg Waypoint

1. Position the screen cursor over the SET WAYPOINT soft key.
2. Left click to reveal a drop down menu containing three options.
3. Either
 - a) Position the cursor over the SELECT FROM DATABASE line.
 - b) Left click to reveal a list of waypoint names from the POSITION DATABASE on the memory card selected.
 - c) Move the cursor to the waypoint you wish to use.
 - d) Left click to select.

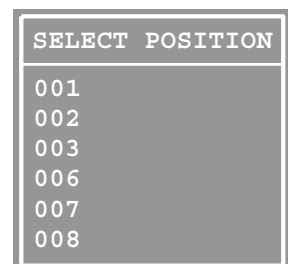
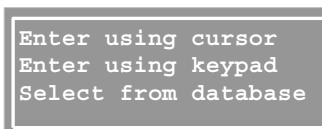

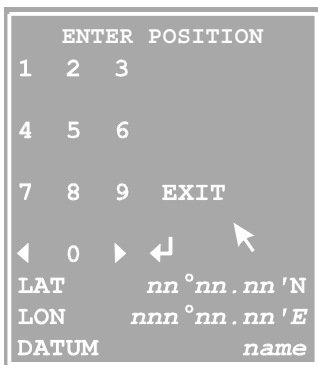

Or

- a) Position the cursor over the ENTER USING CURSOR line.
- b) Left click to reveal a drop down alpha-numeric keypad as shown. See chapter 15 for further information.
- c) Enter the new waypoint name at the bottom.
- d) Position the cursor over the 'carriage return' symbol and left click.
- e) Position the screen cursor at the waypoint location required and left click.

Or

- a) Position the cursor over the ENTER USING KEYPAD line.
- b) Left click to reveal a drop down alpha-numeric keypad as shown. See chapter 15 for further information.
- c) Enter the new waypoint name at the bottom.
- d) Position the cursor over the 'carriage return' symbol and left click to reveal an ENTER POSITION numeric keypad as shown.
- e) Use the keypad to enter the required waypoint LAT/LONG position.
- f) Change the datum if required.
- g) Position the cursor over the 'carriage return' symbol and left click to define the waypoint.

Sailing a Single Leg Route

Once the waypoint has been defined a route consisting of two waypoints and a single leg will be displayed on the screen, and sailing will commence automatically.

The menu on display will now show the data of the TO WAYPOINT together with its calculated data.



The STOP SAILING soft key allows the user to stop sailing. When selected a dialog box is displayed to confirm the action.

Position Database

The Position Database is used to store all internal and single leg route waypoint data.

The position database will be created when the first waypoint is stored on that card.

There is a separate store on each memory card.

Editing the Position Database

1. Position the screen cursor over the POSITION DATABASE line in the NAVIGATION menu.
2. Left click to reveal the POSITION DATABASE menu shown on the left.



The data that is initially shown is for the first waypoint on CARD A. The POSITION line shows how many waypoint definitions are stored in the DATABASE on the card selected.



To change the DATABASE to the other memory card, click on the CARD line to toggle between A and B.

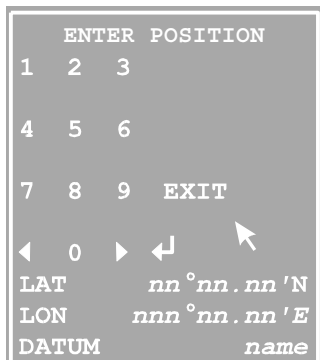
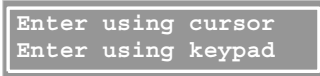

Adding a Waypoint to the Database

1. Position the screen cursor over the ADD soft key.
2. Left click to reveal a drop down menu containing two options.
3. Either
 - a) Position the cursor over the ENTER USING CURSOR line.
 - b) Left click to reveal a drop down alpha-numeric keypad as shown. See chapter 15 for further information.
 - c) Enter the waypoint name at the bottom.
 - d) Position the cursor over the 'carriage return' symbol and left click.
 - e) Position the screen cursor at the waypoint location required and left click.

Or

- a) Position the cursor over the ENTER USING KEYPAD line.
 - b) Left click to reveal a drop down alpha-numeric keypad as shown. See chapter 15 for further information.
 - c) Enter the waypoint name at the bottom.
 - d) Position the cursor over the 'carriage return' symbol and left click to reveal an ENTER POSITION numeric keypad as shown.
 - e) Use the keypad to enter the required waypoint LAT/LONG position.
 - f) Change the datum if required.
 - g) Position the cursor over the 'carriage return' symbol and left click.
4. The data for that waypoint has now been entered and will be displayed in the menu. The number of waypoints in that cards database will also increase by one.

Note: The preferred entry for WAYPOINTS is by entering their LAT/LONG position taken from a CHART, using the DATUM of the CHART.

Displaying the Waypoint Information in the Database

The six arrow keys allow you to display all the different waypoints in the database.



The single arrow keys enable you to step on or step back one waypoint at a time.



The double arrow keys enable you to step on or step back ten waypoints at a time in the database.



The double arrow and line keys enable you to go to the start or end of the database.

Editing the Waypoint data in the Database

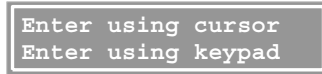

1. Display the waypoint data to be edited.
2. Position the cursor over the LAT/LONG lines.
3. Left click to reveal a drop down menu containing two options as shown.
4. Either
 - a) Position the cursor over the ENTER USING CURSOR line and left click.
 - b) The screen cursor will be re-positioned in the centre of the video circle, and a prompt 'Select a position' will be displayed.
 - c) Use the cursor to select the new position and left click.
- Or
 - a) Position the cursor over the ENTER USING KEYPAD line.
 - b) Left click to reveal a drop down numeric keypad as shown on the left.
 - c) Use the keypad to enter the Latitude and Longitude of the waypoint.
 - d) If the datum displayed is incorrect for the lat/long about to be entered, position the cursor over the DATUM caption and left click. This will reveal a list of the datums available. A right click will remove the keypad without further action.
 - e) Left click on the datum associated with the Latitude and Longitude in use. The datum selected is retained throughout the editing session until changed.

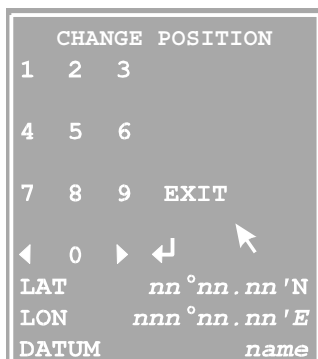

- f) Position the cursor over the 'carriage return' symbol and left click. ↵
5. The data for the waypoint will now be updated in the menu.

Changing the Waypoint name in the Database

Note – If a waypoint name is changed, it will not be possible to use a route that uses the original name of the waypoint. **WARNING – USE WITH CAUTION.**

1. Display the waypoint name to be changed in the POSITION DATABASE menu.
2. Position the cursor over the existing NAME of the waypoint in the menu.
3. Left click to reveal a drop down alpha-numeric keypad as shown.
4. Enter the new waypoint name at the bottom.
5. Position the cursor over the 'carriage return' symbol and left click. ↵

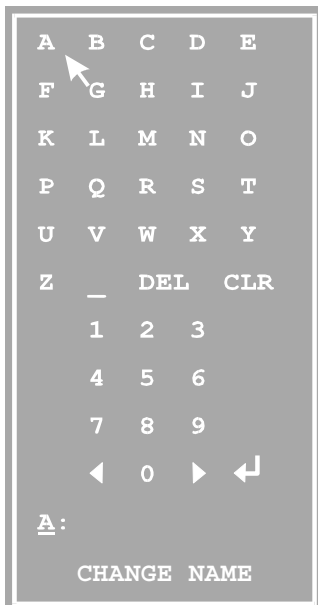

Deleting a Waypoint from the Database

Note – This will permanently remove the waypoint and its data from the database. It will not be possible to use a route that uses the deleted waypoint. **WARNING – USE WITH CAUTION.**

1. Display the waypoint data to be deleted in the POSITION DATABASE menu.
2. Position the cursor over the DELETE key and left click.
3. A confirm dialog box will be displayed.
4. Left click on YES to confirm delete.



Route and Waypoint Transfer (ARPA only)

The System Initialisation and Commissioning section of the Ship's Manual (chapter 4) gives details of how to enable the transfer of route and waypoint data.

When ROUTE & WAYPOINT TRANSFER has been set up as an input device, and the NAV soft key is selected, the NAVIGATION menu display will now include a ROUTE TRANSFER line as shown.

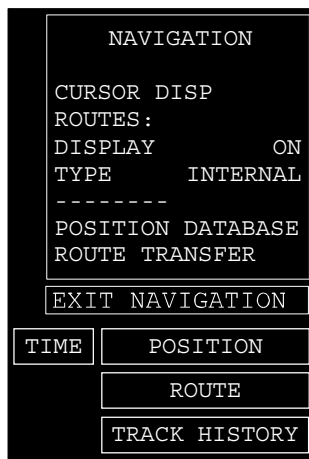

This function enables route files (.RTE) to be transferred to a memory card and waypoint positions to be added to the POSITION DATABASE.

For the Route and Waypoint Transfer to function successfully, the following points must be observed.

- A memory card, which is NOT write protected must be fitted in the slot specified.
- There must be sufficient space on the memory card to save the .RTE (route) file.

Transferring Routes and Waypoints

1. Position the cursor over the ROUTE TRANSFER line in the NAVIGATION menu.
2. Left click to reveal the ROUTE TRANSFER menu shown on the left.

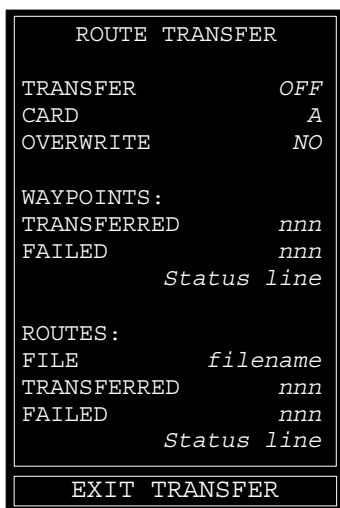

A left click on the TRANSFER line will toggle the input on and off.



A left click on the CARD line will toggle from A to B indicating which card the data is to be transferred to.



A left click on the OVERWRITE line will toggle this option on and off.



A left click on the EXIT TRANSFER soft key will close the menu and end the transfer.

The card and overwrite lines can only be changed when the transfer is off.

Data will only be transferred while the menu is displayed and Transfer is set to on

Statistics and Errors

While data is being transferred the following statistics will be available.

The TRANSFERRED lines will indicate the number of routes or waypoints successfully transferred.

The FAILED lines will indicate the number of routes or waypoints not successfully transferred.

The ROUTES FILE line will indicate the filename of the route being transferred.

The STATUS lines on the menu will show the status of the transfer. This will normally be LOADING during transfer and TRANSFER OK at the end.

Transferred data will be checked for its validity. If any data is considered to be invalid it will be ignored.

The following self-explanatory information may be shown on the status line.

- CAN'T OVERWRITE
- INVALID ROUTE NAME
- INVALID WAYPOINT NAME
- INCOMPLETE DATA
- INVALID ROUTE
- INVALID POSITION
- DATABASE FULL

CHAPTER Maps 10

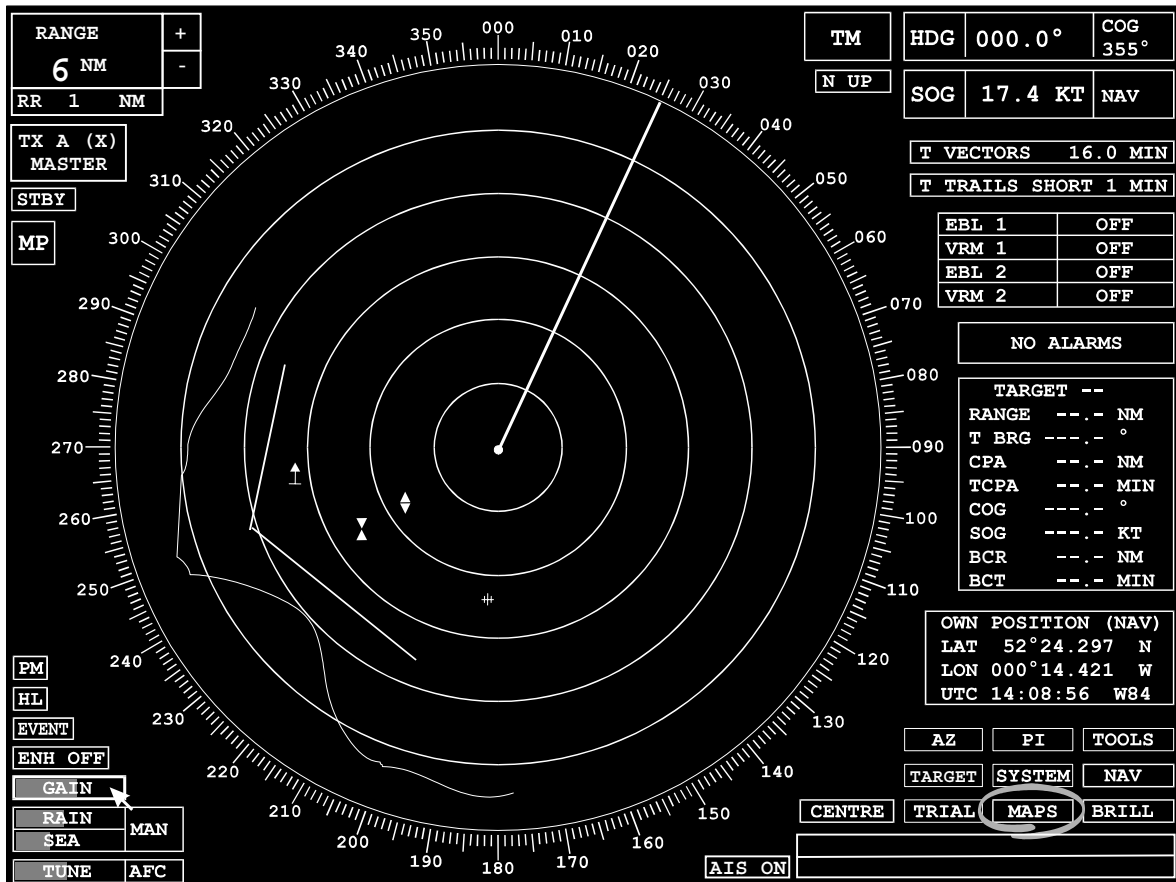

Covered in this chapter:

- Displaying maps.
- Selecting a map and choosing which features will be displayed.
- Creating, editing and deleting maps.
- Creating, editing and deleting guard lines.



Introduction

The **MAPS** facility allows user defined Maps and Guard Lines to be displayed within the video circle.

MAPS and GUARD LINES can be displayed in either STANDBY or TRANSMIT mode.

They can only be displayed in stabilized presentation modes (North-Up or Course-Up) and only on range scales of 0.5NM and above.

They cannot be displayed at latitudes further north than 78°N or further south than 78°S.

Maps are stored as files on a memory card and can be selected for display either individually or as a folio. A folio is a collection of up to 10 maps. Up to 500 elements of a map can be displayed at any one time. When a folio is selected for display, the closest 500 elements to own ship are automatically selected from ALL the maps in the folio. This enables maps for particular routes to be grouped together and automatically displayed when own ship's lat/long is appropriate.

Offsets

In order to compensate for errors in the alignment of maps it is possible to add an OFFSET to a map position. The offset is applied to all points of a map and to all associated layers. The same offset is applied to all maps in a folio.

Layers

Individual maps are LAYERED with each layer containing a different type of data such as coastlines, buoys, etc. Individual layers can then be selected for display. Layers are provided for the following sets of data.

- Dangers.
- Buoy and beacons.
- Coastline.
- Ship safety contour
- Traffic zones.
- Prohibited areas.
- Channel boundaries

Note – Layers, line type and colour, are designed to comply with the ECDIS IEC61174 (Draft) specification.

Guard Lines

Up to twenty guard lines, each defined by a start and end position, can be displayed. When the guard lines are 'active', an alarm is raised when any of the lines are crossed by own ship. Guard lines are displayed as thick red lines when active. When a crossing alarm is raised, the guard line being crossed will flash until the alarm is acknowledged. Guard lines are not available on an EPA(L).

Datums

Maps are always displayed and stored referenced to the W84 (WGS84) datum. However, manually entered map elements can be entered using lat/long references in datums other than W84 (WGS84).

Turning the Maps Display ON and OFF

This key provides an easy way of suppressing the display of maps and guard lines.



1. Position the screen cursor over the MAPS soft key.
2. Right click to toggle between maps ON and maps OFF.

Note – When **ON** is selected, only the map features which were previously turned ON from within the MAPS menu are displayed. See **Map Facilities**.

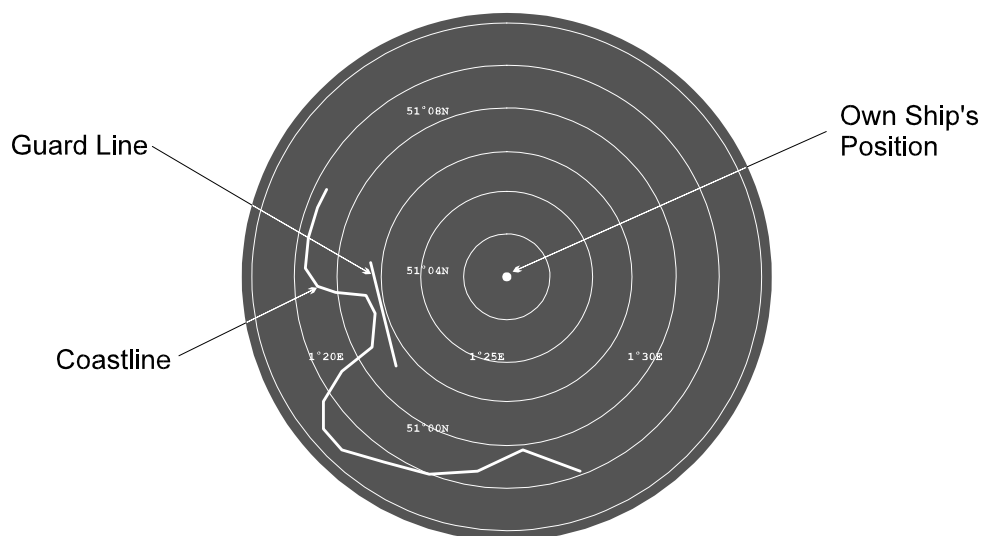

Video Circle
MAPS Display

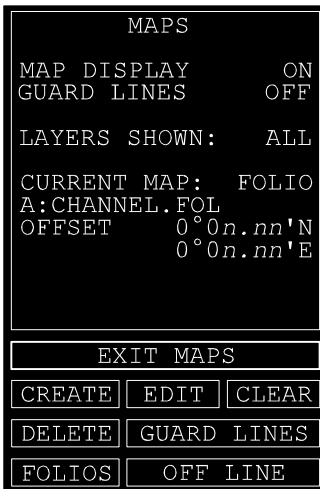

MAP Facilities

1. Position the screen cursor over the MAPS soft key.
2. Left click to reveal the MAPS menu and soft keys shown on the left.

The soft keys, associated with the MAPS menu, enable maps, layers, folios and guard lines to be created, edited, cleared and deleted.

Notes

1. For use of EPA(L) radars, see **MAP Facilities for EPA(L) Radars** at the end of the chapter.
2. For users with a Navline Interface fitted and initialized, see the **Navline Interface** section at the end of the chapter.

Selecting Maps and Folios from a Memory Card

1. Within the MAPS menu, position the screen cursor over the **filename** of the map or folio currently selected, or the line of dashes if none have been previously selected. (A:CHANNEL.FOL in the example above left).
2. Left click to reveal a drop down menu as shown on the left.

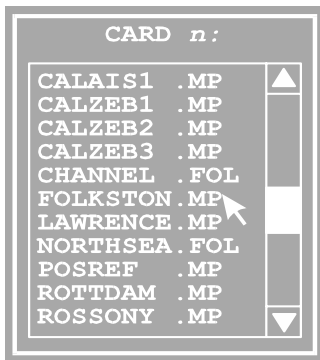

Note – This menu contains a list of filenames for the maps and folios stored on the selected memory card, CARD A or CARD B. The card selected is indicated in the line at the top of the menu. A right click will close the menu with no further action.

3. Position the screen cursor over the CARD n: line, and left click to select the card required.
4. Position the screen cursor over the filename of the map or folio you wish to recall. The file selected will be highlighted. Use the scroll facility if required.
5. Left click to select.
ALL layers of the map or folio selected will be switched ON.

Note – A selected map or folio will NOT be switched ON if certain parameter limits are exceeded, see **Warning Prompts** at the end of the Chapter. A warning prompt will also be given if maps are missing from a selected folio.

The missing maps can be identified by left clicking on the FOLIOS soft key – the missing maps are shown in RED.

Turning the Selected Map On and OFF

1. Within the MAPS menu, position the screen cursor over the MAP DISPLAY caption.
2. Left click to toggle between map ON and map OFF.

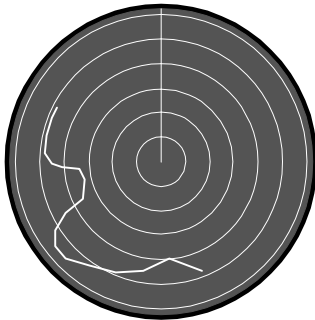

Map ON

Note – A selected map or folio will NOT be switched ON if certain parameter limits are exceeded, see **Warning Prompts** at the end of the Chapter.

Offsetting Map position

A map can be re-aligned by up to a maximum of 9.99' in both axis to compensate for errors in position information. This allows a map to be aligned with known targets and map symbols. Offsetting can be achieved by either the direct input of a numeric offset, or by a process of dragging within the video circle.

Offsetting a Map by Direct Input

1. Within the MAPS menu, position the screen cursor over the OFFSET line.
2. Right click to reveal the OFFSET drop down keypad from where the relevant offsets can be entered, see Chapter 15.



Offsetting a Map in the Video Circle

1. Within the MAPS menu, position the screen cursor over the OFFSET line.
2. Left click to activate the dragging facility.
3. Move the cursor into the video circle and position it over a map segment.
4. Press and hold down the left key, and then drag the map to the required offset position.
5. Release the left key.

The offset will not be accepted if the map is dragged beyond the 9.99' limits in either axis. In such cases, the map will return to its original position when the key is released.

Selecting Map Layers

Where a map contains more than one layer, the selection and deselection of layers is made via the LAYERS SHOWN caption in the MAPS menu.

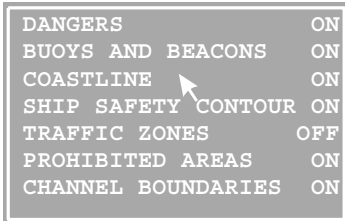

1. Position the screen cursor over the LAYERS caption.
2. Left click to reveal a drop down menu, containing a list of the layers available, as shown on the left.
3. Position the cursor over the layer which is to be switched ON or OFF.
4. Left click to toggle the layer ON and OFF.
5. Right click to close the drop down menu.

Note – If any layer is switched OFF, the LAYERS caption in the MAPS menu will change from ALL to USER, see example left. At least one layer must be selected ON at all times. If only one layer is switched ON, the user is prevented from switching that layer OFF until at least one other layer is switched ON first.



Activating and De-activating Guard Lines



1. Within the MAPS menu, position the screen cursor over the GUARD LINES caption.
2. Left click to toggle the guard line function between ON and OFF.

When GUARD LINES are OFF (Inactive) no GUARD LINE alarms will be raised, and no GUARD LINES will be drawn on the screen.

This function is also available within the GUARD LINES menu.

See warning prompts at the end of the chapter.

Deselecting Maps

A map or folio can be deselected using the **CLEAR** soft key.

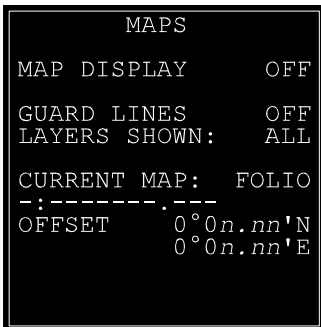

To deselect a map or folio;

1. Position the screen cursor over the CLEAR soft key.
2. Left click to clear the MAP or FOLIO currently selected in the MAPS menu.
The filename is **dashed out** and the maps DISPLAY is forced **OFF**, see example left. Any map OFFSET that has been added is also cleared.

Deleting a Map from a Memory Card



WARNING - THIS ACTION CANNOT BE UNDONE.

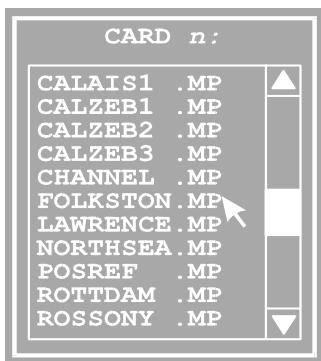

1. Position the screen cursor over the DELETE soft key.
2. Left click to reveal a drop down menu as shown on the left.

Note – This menu contains a list of filenames for the map stored on the selected memory card, CARD A or CARD B. The card selected is indicated in the line at the top of the menu. A right click will close the menu with no further action.

3. To change the selected card, position the screen cursor over the CARD n: line, and left click.
4. Position the screen cursor over the filename of the map you wish to delete. Use the scroll facility if required. The file selected will be highlighted.
5. Left click to delete. This will reveal a YES/NO dialog box. Left click on YES to delete the map. The selected map is now completely deleted from the memory card.

Creating and Editing Maps/Layers

The procedures for creating maps, and those for editing maps, are very similar. Editing is always for the map currently selected in the MAPS menu. See **Selecting Maps and Folios from a Memory Card**. When creating a map the user is initially prompted to enter a **new filename** for the map about to be created. After the new filename has been entered, the remaining procedures for creating a map are the same as those for editing.

Note: *The preferred entry for MAPS is by entering their LAT/LONG position taken from a CHART, using the DATUM of the CHART. This will minimize any angular alignment errors caused by COMPASS and HM offset inaccuracies.*

Creating a New Map

1. Position the screen cursor over the CREATE soft key.
2. Left click to reveal a drop down alpha-numeric keypad as shown on the left.
Alpha-numeric keypads and their use are described in Chapter 15.
3. Enter the card and filename under which the new map will be saved.
4. When the card and filename is as required, position the screen cursor over the 'carriage return' symbol.
5. Left click to save.
This will create the file on the selected memory card under the chosen filename, see notes below.



Notes

1. *If the chosen filename already exists, the name is not accepted, the keypad menu closes and the message 'File already exists' is displayed on the temporary prompt line.*
2. *If the chosen filename is accepted, the **MAP EDIT** menu is automatically displayed. Proceed to the section on map editing which follows.*

Editing a Selected Map

A map can be edited in TRANSMIT mode provided its lat/long is close to the current lat/long position. If this is not the case, the map must be edited in STANDBY mode. In order to do this, the cursor lat/long and range, must be set so that the map can be displayed.

Displaying a Map for Editing in STANDBY Mode

Note – The MAP display is switched-OFF when changing from TRANSMIT mode to STANDBY mode. Hence, the MAP display must be switched-ON again when in STANDBY.

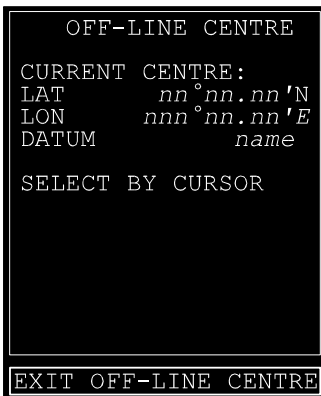

1. If necessary, select the MAPS facility by left clicking on the MAPS soft key.
2. If necessary, select the required map from the MAPS menu.
3. Within the MAPS menu, position the screen cursor over the MAP DISPLAY caption.
4. Left click to toggle for map ON.
5. Position the screen cursor over the OFF-LINE soft key under the MAPS menu.
6. Left click to reveal the OFF-LINE CENTRE menu shown on the left.

Note – The Lat/Long and datum information displayed in the menu defaults to the most recent values set in this mode.

7. If the datum of the lat/long about to be entered (Step 8) is not that displayed in the menu, left click on the DATUM line to reveal a list of the datums available. Left click on the datum required.
8. Within the menu, left click on the LAT or LONG line to reveal a drop down numeric keypad. Use the keypad to enter the Lat/Long of the selected map.



Additionally, a left click on the SELECT BY CURSOR line causes a + cursor to appear at the centre of the video circle. To change the centre position, left click with the cursor control at the appropriate position. The map will then be re-drawn, with this position as the centre of the video circle

The map can now be edited in the normal way using the editing procedures given on the following pages.



A left click on the EXIT OFF-LINE CENTRE key will close the menu.

Map Editing Procedures



1. Position the screen cursor over the EDIT soft key.
2. Left click to reveal the EDIT MAPS menu and soft keys shown on the left.



Note – The particular layer of the map that you wish to edit **MUST** now be selected before proceeding, see **Selecting a Map Layer** below. When in EDIT mode all layers of a map will be displayed, when the edit is finished the LAYERS SHOWN will stay as ALL and not revert to USER. (See Selecting Map Layers earlier in the chapter).

The SYMBOL line will only be present in the menu if the selected layer contains symbols.

Note – A left click on the EXIT EDIT MAPS soft key will close the menu and re-display the MAPS menu.

Selecting a Map LAYER

1. Position the cursor over the LAYER name caption in the menu (DANGERS in the example above left).
2. Left click to toggle through the LAYER options available.

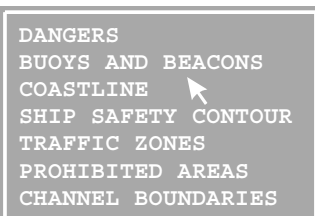

Alternatively a right click will reveal the drop down menu shown on the left. Left click on the type of layer required. The layer selected will appear in the LAYER name line of the EDIT MAPS Menu.

Each layer conveys information as a series of predefined lines or symbols as indicated below.

Dangers:	Various symbols, in magenta.
Buoys and beacons:	Various symbols, each with its own predefined colour (either red or green).
Coastline:	Continuous white line.
Ship safety contour:	Continuous grey line.
Traffic zones:	Continuous magenta line.
Prohibited areas:	Dashed magenta line
Channel boundaries:	Dashed grey line.

After a layer has been selected, select the required edit mode as follows.

Selecting an Edit MODE

1. Position the cursor over the Mode caption in the EDIT MAPS menu.
2. Left click to toggle through the EDIT options available (ADD, DELETE, MOVE or MODIFY).

Note – *The MODIFY option is only available when editing symbols. It is not available for editing 'lines'.*

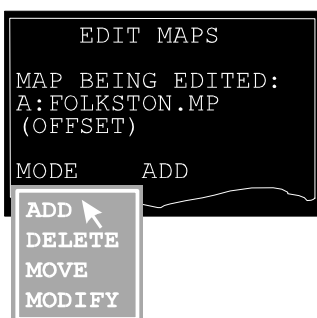

Alternatively a right click will reveal the drop down menu shown on the left. Left click on the edit mode required. The mode selected will appear in the MODE line of the EDIT MAPS Menu.

Adding Lines and Symbols to a Map

The ADD mode of editing allows the user to add lines or symbols to the selected layer, either from within the video circle or by lat/long entries in the EDIT MAPS menu.

Note – *The maximum recommended number of elements stored in a map (an element is a single line or symbol) is 1000. The map will take longer to display if this number is exceeded.*

Adding Lines in the Video Circle

This ONLY applies to layers which use lines.

1. Within the video circle, position the screen cursor at the start point of the line required.
2. Left click to define the point.
3. Move the cursor to the next point.
4. Left click to define the second point.
5. Repeat Steps 3 and 4 as often as required to build the required contour.
6. Right click on the last point or on the NEW LINE soft key to end the contour.

Note – *The above process can be repeated as often as required to add more lines.*

Adding Symbols via the Video Circle

This ONLY applies to layers which use symbols.

1. Position the screen cursor over the SYMBOL line in the EDIT MAPS menu.
2. Left click to toggle through the SYMBOL options available.
Alternatively a right click will reveal a drop down menu containing a range of symbols in their respective colours. Left click on the symbol required. The selected symbol will appear in the SYMBOL line of the menu.
3. Within the video circle, position the cursor at the point where you want the symbol placed.
4. Left click to place.
The selected symbol will appear in the video circle.

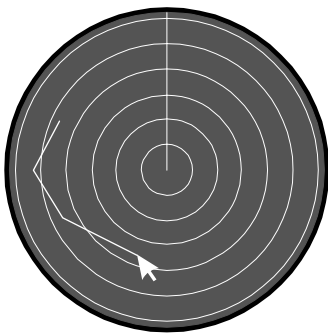

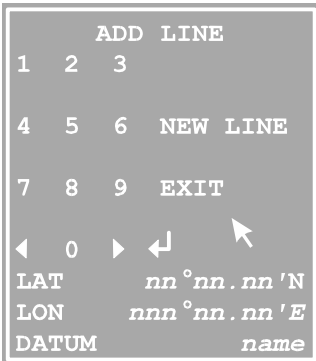

Adding Lines by Entering a Lat/Lon

This ONLY applies to layers which use lines.

1. Position the screen cursor over the LAT/LON line in the EDIT MAPS menu.
2. Left click to reveal a drop down numeric keypad as shown on the left.
3. If the datum displayed is incorrect for the lat/long about to be entered (Step 5), position the cursor over the DATUM caption and left click.
This will reveal a list of the datums available. A right click will remove the keypad without further action.
4. Left click on the datum associated with the Latitude and Longitude in use.
The datum selected is retained throughout the editing session until changed.
5. Use the keypad to enter the Latitude and Longitude of the start position.
6. Position the cursor over the 'carriage return' symbol ↵ and left click to define the start position.
7. Use the keypad to enter the Latitude and Longitude for the next position.
8. Position the cursor over the 'carriage return' symbol ↵ and left click to define that position.
9. Repeat Steps 7 and 8 as often as required to build the required contour, or select NEW LINE to end the current line and start a new one.

Note – The above process can be repeated as often as required to add more lines.

10. Left click on the EXIT caption to end the process and close the drop down keypad.

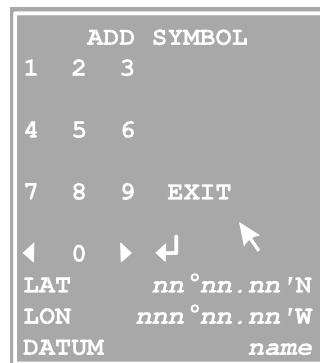

Adding Symbols by Entering a Lat/Lon

This ONLY applies to layers which use symbols.

1. Position the screen cursor over the SYMBOL line in the EDIT MAPS menu.
2. Left click to toggle through the SYMBOL options available.
Alternatively a right click will reveal a drop down menu containing a range of symbols in their respective colours. Left click on the symbol required. The selected symbol will appear in the SYMBOL line of the menu.
3. Position the screen cursor over the LAT/LON line in the EDIT MAPS menu.
4. Left click to reveal the drop down numeric keypad shown on the left.
5. If the datum displayed is incorrect for the lat/long about to be entered (Step 7), position the cursor over the DATUM caption and left click.
This will reveal a list of the datums available. A right click will remove the keypad without further action.
6. Left click on the datum associated with the Latitude and Longitude in use.
The datum selected is retained throughout the editing session until changed.
7. Use the keypad to enter the Latitude and Longitude of the position where you want the symbol placed.
8. Position the cursor over the 'carriage return' symbol ↵ and left click to define the position.
9. Repeat Steps 7 and 8 as often as required.
10. Left click on the EXIT caption to end the process and close the drop down keypad.

Deleting Lines and Symbols from a Map

The DELETE mode of editing allows the user to delete single segment lines, points within a contour and symbols from within the video circle, on the selected layer.

Deleting Lines and Symbols in the Video Circle

1. Within the video circle, position the cursor over the symbol, or over a point on the contour, or at any point along the single segment line, you wish to delete.
2. Left click to delete.

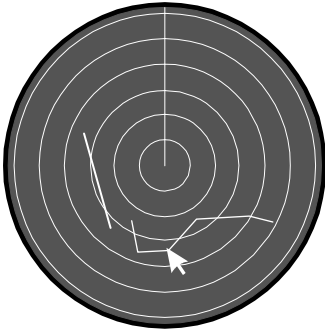

Left click to delete
point in contour

Note – A left click on a point will result in two segments being deleted and the remaining end points being joined.

Moving Lines and Symbols on a Map

The MOVE mode of editing allows the user to move lines and symbols from within the video circle, on the selected layer

Moving Lines and Symbols in the Video Circle

1. Within the video circle, position the cursor over the symbol, or the point on a line, you wish to move.
2. Press and hold down the left key.
3. Drag the selected point to its new position.
4. Release the left key.

Note – *If the start or end point of a line is selected, the line will move when dragged. If a point within a line is selected, the line will be split into two segments and the drag will affect both segments.*

Modify Map Symbols

The MODIFY mode of editing allows the user to change a map symbol from within the video circle, on the selected layer.

Modifying Symbols in the Video Circle

1. Position the screen cursor over the SYMBOL line in the EDIT MAP menu.
2. Left click to toggle through the SYMBOL options available.
Alternatively a right click will reveal a drop down menu containing a range of symbols in their respective colours. Left click on the symbol required. The selected symbol will appear in the SYMBOL line of the menu.
3. Within the video circle, position the cursor over the symbol you wish to change.
4. Left click to replace the symbol with the one selected in the menu.





Saving a Map

A left click on the SAVE soft key allows the user to save a map that is being created or edited, to the memory card. This should be done regularly to guard against the risk of data loss.

Note - If an attempt is made to exit from the EDIT MAPS menu when there are unsaved edits, the user will be prompted, in the form of a dialog box, to save the current edits before exiting. Also if over 100 edits have been made without saving, a brief prompt will be displayed as a reminder to save the map.

Creating and Editing Folios

The Folios facility allows the user to create a new folio of up to ten maps, and to edit or delete existing folios. A folio can only be created from maps located on the same memory card as the folio. If necessary, move maps before creating the folio.

Viewing the Current Folio

1. Position the screen cursor over the FOLIOS soft key.
2. Left click to reveal the FOLIO menu and soft keys shown on the left.
The menu will be for the FOLIO currently selected in the MAPS menu (See **Selecting Maps and Folios from Memory**). If a folio hasn't been selected, it will be untitled.

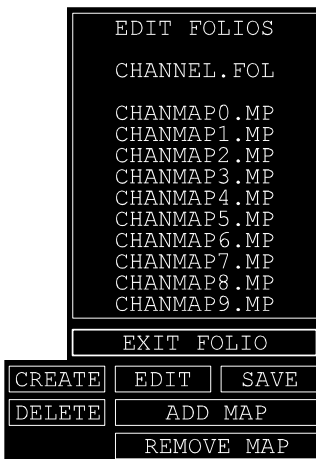

Note – A left click on the EXIT FOLIO soft key will close the FOLIO menu **unless** edits have been made which have not been saved. In which case, the user is prompted to save their changes before exiting.

Creating a New Folio

1. Position the screen cursor over the CREATE soft key.
2. Left click to reveal the CREATE NAME drop down keypad.



Note – This keypad is the same as that explained under **CREATING a New Map** earlier in the chapter. It allows the entry of a memory card identifying letter and an 8 character filename. The filename extension is fixed as **.FOL**.

Once the new filename has been entered and accepted, the functions of ADD MAP, REMOVE MAP and SAVE can be used.

Adding a Map to a Folio

ADD MAP

1. Position the screen cursor over the ADD MAP soft key.
2. Left click to reveal a CARD menu containing a list of the MAPS available. (This is the card on which the Folio has been created).

Note – At this point, a right click will close the CARD menu and re-display the FOLIO menu.

3. Within the CARD menu, left click on the map to be included in the folio. After this selection, the menu is closed leaving the cursor over the ADD MAP soft key.
4. Repeat steps 2 and 3 until all required maps have been added. A prompt will be displayed when the folio is full (contains ten maps).

Removing a Map from a Folio

REMOVE MAP

1. Position the screen cursor over the REMOVE MAP soft key.
2. Left click to reveal a drop down menu containing a list of the MAPS in the folio.

Note – A right click at this point will close the drop down menu and re-display the FOLIO menu.

3. Within the drop down menu, left click on the map to be removed from the folio. After this selection, the menu is closed leaving the cursor over the REMOVE MAP soft key.
4. Repeat steps 2 and 3 until all required maps have been removed.



Saving a Folio

A left click on the SAVE soft key allows the user to save a newly created folio, or an edited folio, to the memory card.

Note – If an attempt is made to exit from the EDIT FOLIO menu when there are unsaved edits, the user will be prompted, in the form of a dialog box, to save the current edits before exiting.

Editing a Folio

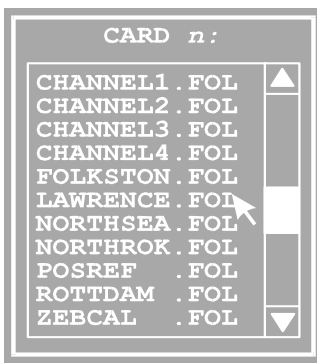

1. Position the screen cursor over the EDIT soft key located below the EDIT FOLIOS menu.
2. Left click to reveal a drop down menu containing a list of FOLIO filenames. (A further right click will remove the menu without taking further action).
3. Within the menu, left click on the **CARD n** line to select the card required, CARD A or CARD B.
4. Left click on the filename of the folio you wish to edit. The menu for the selected FOLIO will appear and the functions of ADD MAP, REMOVE MAP and SAVE can now be used as described earlier.

Note – A folio that is currently in use cannot be edited.

Deleting a Folio from a Memory Card

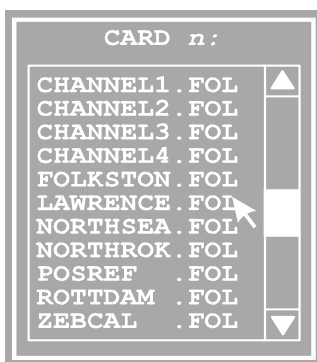

1. Position the screen cursor over the DELETE soft key.
2. Left click to reveal a drop down menu containing a list of folios as shown on the left.
3. Within the menu, left click on the **CARD n** line to select the card required, CARD A or CARD B.
4. Left click on the filename of the folio you wish to delete. This will reveal a YES/NO dialog box. Left click on YES to delete the folio.
5. Right click to close the list and re-display the FOLIO menu.

Creating and Deleting Guard Lines

Guard lines can be created by entering their start and end positions either in the video circle or in a drop down lat/long keypad accessed from the GUARD LINES menus. Guard lines are drawn in mauve and are inactive (off) during editing. They are activated and drawn in red on exiting from the Guard Lines menu.

Viewing the Current Guard Line Selection



1. Position the screen cursor over the GUARD LINES soft key.
2. Left click to reveal the GUARD LINES menu and soft key shown on the left.

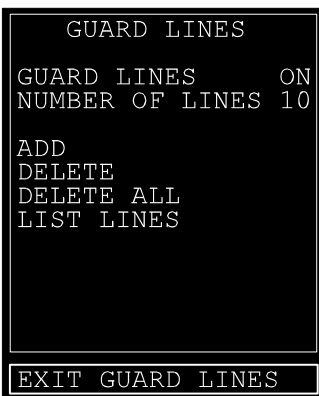

The 'NUMBER OF LINES' line in the menu indicates the number of guard lines currently defined. A maximum of up to 20 guard lines can be defined.

Note – A left click on the EXIT GUARD LINES soft key will close the menu and re-display the MAPS menu. Guard lines are stored in non-volatile memory.

Activating and Deactivating Guard Lines



1. Within the GUARD LINES menu, position the screen cursor over the GUARD LINES caption.
2. Left click to toggle the guard line function between ON and OFF.

This function is also available on the main MAPS menu.

Adding Guard Lines in the Video Circle

Guard lines are defined by a 'start-of-line' position and an 'end-of-line' position. They can only be added in TRANSMIT.



1. Position the screen cursor over the ADD line in the GUARD LINES menu.
2. Left click to select.

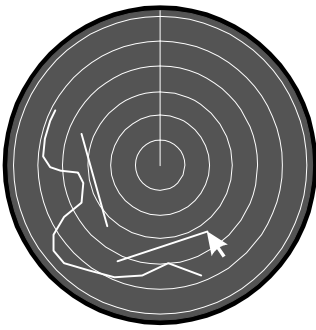

Left click to start line
Left click to end line

3. Move the cursor into the video circle and position it at the start point of the line required.
4. Left click to define the point.
5. Move the cursor to the end point.
6. Left click to define the end point.
7. Repeat Steps 3 to 6 as often as required to create up to twenty guard lines.

A right click will undo the last position.

You will be prompted when the maximum number of lines is defined.



Deleting Guard Lines via the Video Circle

1. Position the screen cursor over the DELETE line in the GUARD LINES menu. Individual lines can only be deleted in TRANSMIT.
2. Left click to select.
3. Move the cursor into the video circle and position it anywhere on the guard line you wish to delete.
4. Left click to delete.

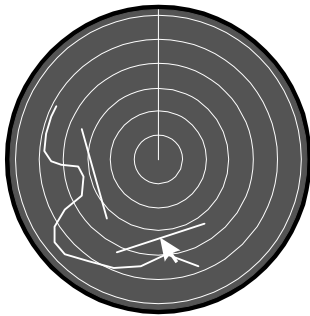

Left click to delete



Deleting ALL Guard Lines

1. Position the screen cursor over the DELETE ALL line in the GUARD LINES menu.
2. Left click to select. This will reveal an ACCEPT/CANCEL dialog box. Left click on ACCEPT to delete. This will delete all guard lines from the system.



Viewing Guard Lines using the MENU

1. Position the screen cursor over the LIST LINES caption in the GUARD LINES menu.

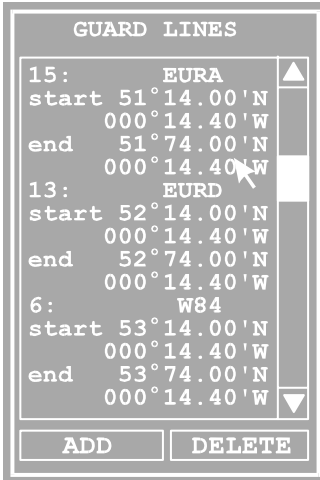

- Let click to reveal a drop down list and soft keys as shown left. Use the scroll bar as required to view the List.
- Follow the instructions below to add lines to or delete lines from this list.

Note – A right click at any time the list is displayed, will close the list and return the GUARD LINES menu.

Adding Guard Lines using the Keypad

Guard lines are defined by a 'start-of-line' lat/long and an 'end-of-line' lat/long entered in a drop down menu accessed via the ADD soft key.

- Position the screen cursor over the ADD soft key.
- Left click to reveal a drop down numeric keypad from where the datum, 'start-of-line' lat/long and an 'end-of-line' lat/long can be entered. See not below.

Note – Guard line lat/long information can be entered in datums other than W84. First, check that the datum displayed in the keypad is the one required for the start and end lat/long you are about to enter. If it is not the datum required, select the new datum before entering any lat/long.

While the list is displayed, lat/long information on up to a maximum of 20 guard lines can be added.

- Right click to close the list.

Deleting Guard Lines using the LIST

- Scroll the list if required, and left click on the details of the GUARD LINE to be deleted.
(A left click on any line in the list will highlight ALL lines associated with the GUARD LINE).



- Position the screen cursor over the DELETE soft key.
- Left click to delete.

While the list is display as many guard lines as required can be deleted.

- Right click to close the list.

Navline Interface

The System Initialisation and Commissioning section of the Ship's Manual (Chapter 4), gives details of how to enable the Navline Interface as an input device.

When the Navline Interface has been set up as an input device and MAPS is selected, the MAPS menu display is as shown in the example left.

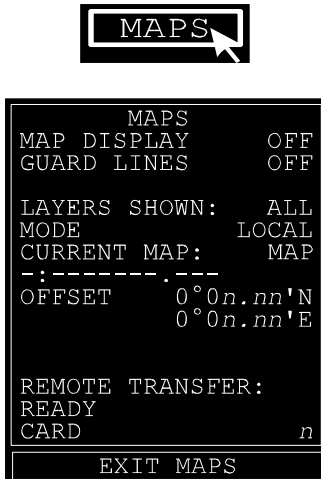

The main differences are, the inclusion of a MODE selection line (LOCAL or REMOTE), and three additional lines, related to mode selection, at the bottom of the menu.

For the Navline Interface to function successfully, the following points must be observed.

- A memory card, which is NOT write protected, must be fitted.
- There must be sufficient space on the memory card to save the (chartname).EXT file.
- REMOTE Mode must be selected.

Mode Selection

1. Position the cursor over the MODE line in the MAPS menu.
2. Left click to toggle for LOCAL or REMOTE (see Note below).

Note – The default mode at switch-ON is **LOCAL**. Before selecting **REMOTE**, make the appropriate memory card selection by left clicking on the 'CARD n' line at the bottom of the menu to toggle for CARD A or CARD B (Navline information is automatically saved to the card selected).

LOCAL Mode

When LOCAL Mode is selected, the radar behaves as if the Navline Interface is not present and can be operated normally, as described in the earlier parts of this chapter.

REMOTE Mode

When REMOTE Mode is selected, navline information is accepted over the interface, and is then converted into a file format with a '.EXT' extension (short for external). This

file is automatically saved to the selected memory card (A or B).



Remote Transfer Status

Within the MAPS menu, the line immediately below the **REMOTE TRANSFER:** line, provides information on the status of the transfer cycle. When Navline information starts being received, the status line caption changes from 'READY' (ie waiting) to 'LOADING', see example left.



When loading is finished, the status changes to 'CONVERTING *nn%*' as the received information is converted into a (**chartname**).**EXT** file for storage on the memory card (see example left). During the conversion phase, the *nn%* figure indicates the percentage conversion so far achieved.

When the conversion phase is completed, the name of the file created, complete with .EXT extension, is displayed immediately below the CURRENT MAP line in the menu. If MAP DISPLAY (top line of menu) is selected ON, the newly converted map will be displayed if appropriate to the current location.

Note – In *REMOTE* mode, the current map is always replaced by the new one received from the VMS.



The radar is now ready to receive further information over the navline interface and the status caption is changed to 'READY', thus completing the cycle (see example left).

If the new map is subsequently modified (ie edited using the procedures contained in the earlier part of this chapter) the edited map will have a '**.MP**' file extension.

MAP Facilities for EPA(L) Radars

The EPA(L) radar has its own internal memory for the storage of map files, and does not use an external memory-card reader.



When MAPS is selected, the MAPS menu display is as shown in the example left.

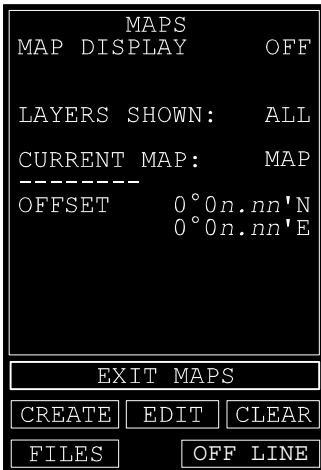

The main differences are, no GUARD LINE or FOLIO facilities and, because the EPA(L) uses an internal memory, the inclusion of a FILES soft key. Operation of the CREATE, EDIT, CLEAR and OFF LINE functions are the same as for other BridgeMaster E (BM E) radars, see MAP Facilities earlier in the chapter.

Selecting Maps from the Internal Memory

1. Within the MAPS menu, position the screen cursor over the **filename** of the map currently selected, or the line of dashes if none have been previously selected.
2. Left click to reveal a drop down menu as shown on the left.

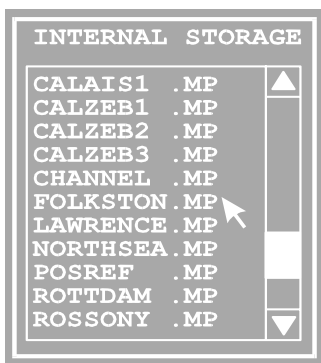

Note – This menu contains a list of filenames for the maps stored in the Internal Memory.

3. Position the screen cursor over the filename of the map you wish to recall. The file selected will be highlighted. Use the scroll facility if required.
4. Left click to select.
ALL layers of the map selected will be switched ON.

Note – A selected map will NOT be switched ON if certain parameter limits are exceeded, see **WARNING Prompts** at the end of the Chapter.

Offsetting a Map

The procedures for offsetting a map (re-aligning) are the same as those described earlier in this chapter under the heading **Offsetting Map position**.

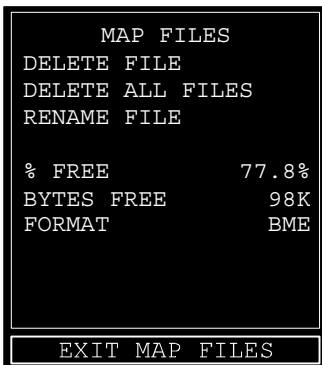

Deleting Maps from the Internal Memory

1. Position the screen cursor over the FILES soft key.
2. Left click to reveal the MAP FILES menu as shown on the left.

An indication of the free space available in the Internal Memory is given in the lower part of the menu.

Deleting a Single Map File

WARNING! – Deleted files CANNOT be recalled.

1. Position the screen cursor over the DELETE FILE line in the MAP FILES menu.
2. Left click to reveal a list of map files stored in the Internal Memory as shown in the example left.
3. Left click on the file to be deleted. This will replace the list with the dialogue box shown lower left.
4. Left click on the **YES** caption to delete the selected file.

Or

Left click on the **NO** to close the dialogue box without taking further action.

Or

Right click to cancel.

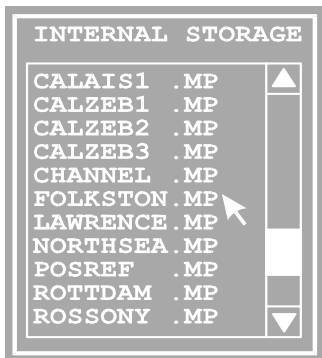

Deleting ALL Map Files

WARNING! – Deleted files CANNOT be recalled.

1. Position the screen cursor over the DELETE ALL FILES line in the MAP FILES menu.
2. Left click to reveal a confirmation box as shown on the left.
3. Click on the **YES** caption to delete all files, or on the **NO** caption to close the box without further action.
4. An ENTER PASSWORD screen will then be displayed. The NAVIGATORS PASSWORD must then be entered to DELETE ALL FILES, or right click to cancel.



Renaming a File

1. Left click on the RENAME FILE line in the MAP FILES menu.

The procedure for renaming a file are now the same as those described in Chapter 14 under the headings Memory Card Facilities, File Management, **To Rename a File**.

Warning Prompts

Warning prompts are displayed when conflicting conditions prevail.

Note – *Only a selection of warning prompts are described.*

Maps and Folios

If an attempt is made to turn-ON a folio or map when the system is unstabilised, outside the allowed range scale, outside the allowed latitude or a NAV alarm is present, an appropriate prompt is displayed and the folio or map is NOT turned ON. See prompts below.

Select stabilised mode

Select a valid range

Own Ship lat/lon is outside valid limits

Own ship lat/lon not available

If a selected Folio has some maps missing, the following prompts is displayed.

Maps missing - select Folios

A left click on the FOLIOS soft key will reveal a list of the maps in the Folio with the missing maps displayed in red.

Guard Lines

If an attempt is made to turn the Guard Lines ON while a NAV POSITION alarm exists, the following prompt is displayed and the guard line is NOT switched on.

```
Own ship lat/lon not available
```

Editing: Lat/Lon Inputs

The following warning prompt is displayed if an attempt is made to enter an invalid lat/long.

```
Invalid Entry
```

Editing: Adding Maps to Folios

The following prompt is displayed when the folio is full (contains the maximum of ten maps).

```
Folio is full
```

Editing: Adding Guard Lines

The following prompt is displayed when the maximum number of guard lines (twenty) have been defined.

```
All guard lines are defined
```

CHAPTER Parallel Index Lines

11

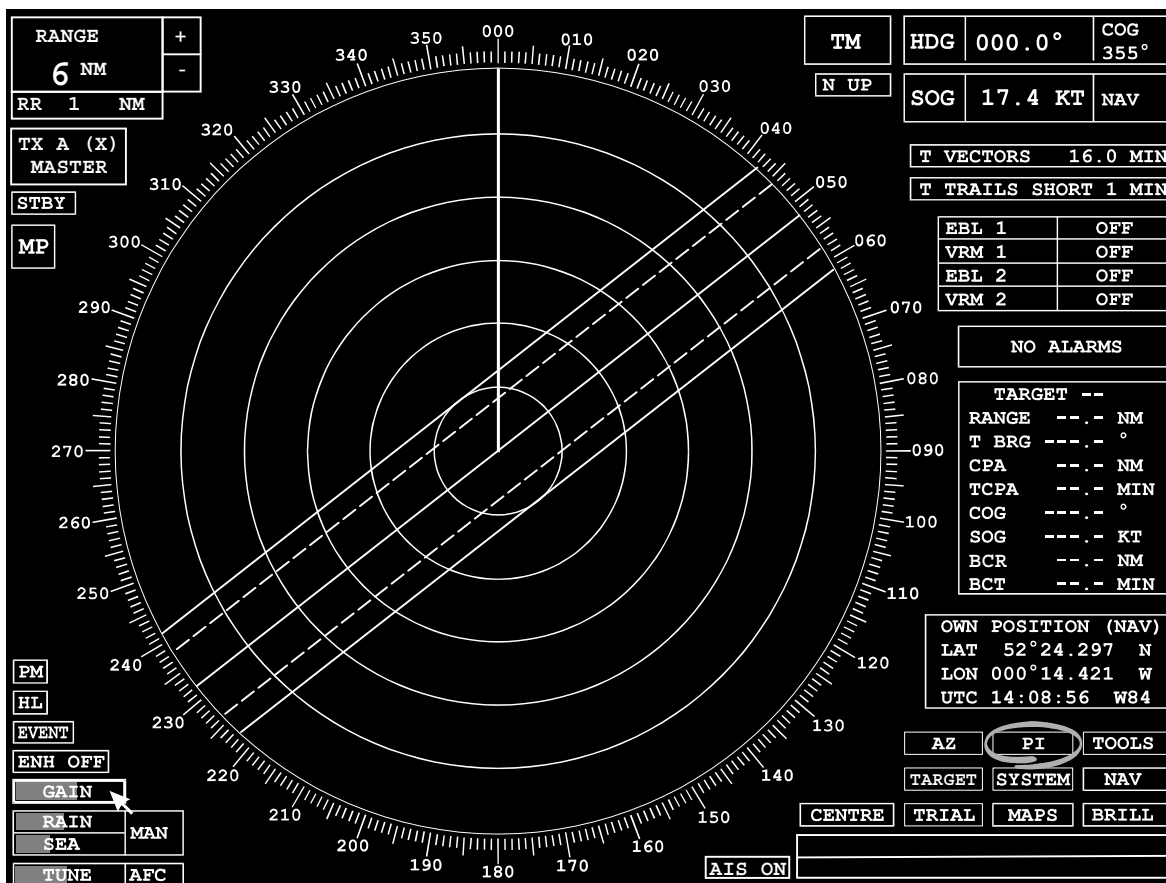

Covered in this chapter:

- Displaying index lines.
- Selecting and editing index lines.

Introduction

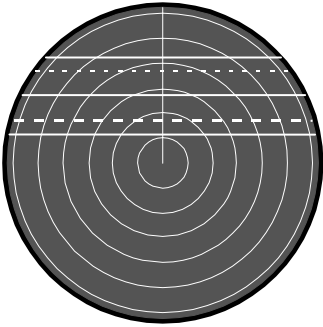

The **Parallel Index Line (PI)** facility allows up to five index lines (only four on EPA(L)) to be displayed simultaneously. The lines span the entire video circle, irrespective of the range scale in use.

Index lines are available in all presentation and motion modes, but only on range scales of 0.25 nm and above. Selecting an invalid range scale will suppress the display of index lines until a valid range is reselected. Index lines are not available in Standby on an EPA(L).

Each index line is defined by the range of its closest point to own ship, its bearing and its line type. Bearings are **true** when in a stabilised presentation mode, but **relative** to own ship's head when in an unstabilised mode.

Switching between stabilised and unstabilised presentation modes, or between standby and transmit, causes the display of index lines to be switched off.

On the EPA(L) and software versions up to 5.00 the index lines are retained in the internal non-volatile memory. From software version 5.01 onwards the index lines can only be stored on to the removable memory card.

In the following chapter all functions related to the memory card are only available from software version 5.01 onwards.

Note – It is not possible to transfer index lines stored in non-volatile memory to a memory card.

Turning the Index Lines Display ON and OFF

1. Position the screen cursor over the PI soft key which is located in the bottom right corner of the display.
2. Right click to toggle the lines ON or OFF.

Note – Index Lines will only be switched on if the INDEX LINE menu is set for DISPLAY ON. When lines are switched-ON, all defined index lines are displayed.





Accessing the Index Lines Menu

1. Position the screen cursor over the **PI** soft key which is located in the bottom right corner of the display.
2. Left click to reveal the Index Lines menu shown on the left. There are two variants of the menu as shown.

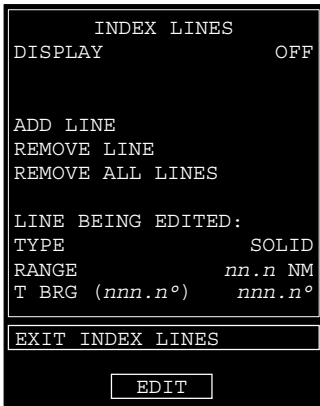

When the INDEX LINES menu is displayed it overwrites the target data and user data areas, and presents a new set of soft keys.

A left click on the EXIT INDEX LINES soft key will close the menu.

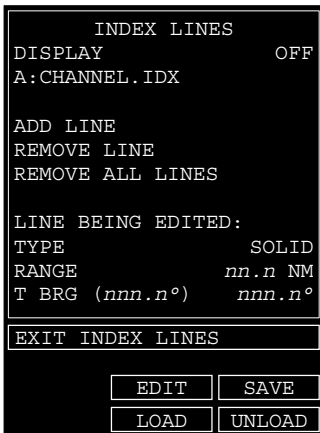

From version 5.01 software an extra line is provided for details of the memory card file, together with LOAD, UNLOAD and SAVE soft keys.



Turning Index Lines ON and OFF

1. Within the menu, position the screen cursor over the DISPLAY line.
2. Left click to toggle index lines between ON and OFF. An appropriate prompt is displayed if conditions are incorrect.

Any defined lines will be shown at their last positions.

From Version 5.01 software onwards an Index Line filename will be required to display any index lines. See over.

Selecting a Group of Index Lines from a Memory Card

1. Within the INDEX LINES menu, position the screen cursor over the filename of the index lines currently selected or the line of dashes if none have been previously selected. (A:CHANNEL.IDX in the example.)
2. Left click to reveal a drop down menu as shown on the left.

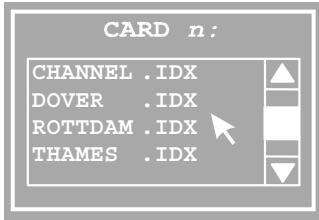

Note – This menu contains a list of filenames for the index lines stored on the selected memory card, either CARD A or CARD B. A right click will close the menu with no further action.

3. Position the screen cursor over the CARD n:line, and left click to select card A or B.
4. Position the screen cursor over the filename of the group of index lines you wish to display. The file selected will be highlighted. Use the scroll facility if required.
5. Left click to select.

The filename of the group of Index Lines will then be displayed in the menu.

Index Line Editing

Within the INDEX LINES menu, all lines from ADD LINE to T-BRG (or R-BRG) are used for editing, but are not active until edit mode is selected and the display of index lines is ON.

Selecting the EDIT mode



1. Position the screen cursor over the EDIT soft key located under the INDEX LINES Menu.
2. Left click to access. A Permanent Prompt 'In Edit Mode' is displayed.

If index lines are already displayed, one line will be shown in magenta to indicate it is ready for editing.

Selecting a Line for editing

The range and bearing of a selected line can be changed by dragging the line within the video circle, or from within the menu using the cursor control or a series of drop down keypads.

1. Within the video circle, position the screen cursor on the line to be edited.
2. Left click to select.
The selected line will be drawn in magenta and its pivot point is marked by a small filled circle. The pivot point is only used during editing. All other lines in the group are drawn in light blue.

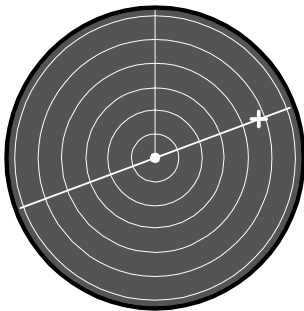

Drag line
to change bearing

Changing the Bearing of Selected Line

1. Within the video circle, position the video cursor over any point on the **line** other than the pivot point.
2. Press and hold down the left key.
3. Rotate the line about the pivot point by dragging to the required **bearing**. The bearing is automatically updated in the menu.
4. Release the left key.

Alternatively a left click on the BRG line in the INDEX LINES menu will allow adjustment using movement of the cursor control. A right click will reveal a drop down numeric keypad from where a new bearing can be entered. Refer to Chapter 15.

The figure given in brackets in the BRG line is the reciprocal bearing of the selected line and is for information only.

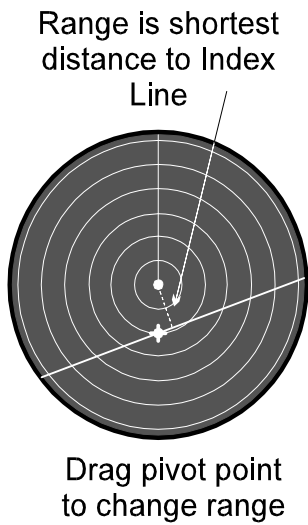

Changing the Range of Selected Line

1. Within the video circle, place the video cursor over the **pivot point** of the selected line.
2. Press and hold down the left key.
3. Drag the line to the required **range** from own ship. The range is automatically updated in the menu.
Note – Range is the shortest distance from Own Ship to index line.
4. Release the left key.

Alternatively a left click on the RANGE line in the INDEX LINES menu will allow adjustment using movement of the cursor control. A right click will reveal a drop down numeric keypad from where a new range can be entered. Refer to Chapter 15.

Changing the Line Type of Selected Line

1. Position the screen cursor over the TYPE line in the menu.
2. Left click to cycle through the line types available (SOLID, or mark/space ratio 1:1 or 3:5 or 1:4 or 2:4 on EPA(L)). The line type displayed is the line type selected.

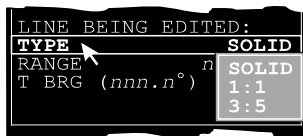

Alternatively, a right click will reveal a drop down menu, as shown on the left, containing a list of the line types available.

Left click on the line type required.



Adding a Line

1. Position the screen cursor over the ADD LINE caption in the INDEX LINES menu.
2. Left click to add.

The new line (at full video circle width) will be drawn in magenta through own ship with its pivot point on own ship. It will be shown either as a vertical line (see example on the left) or at the bearing of any other defined line.

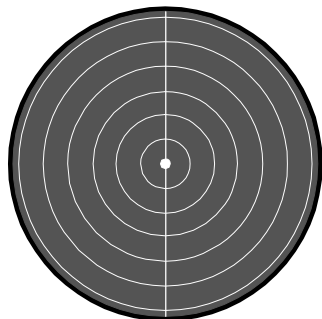

If the maximum number of lines has already been defined, a suitable prompt is displayed and no new line is added.

Once a line has been added, it can be edited in any of the ways already explained (a change of range, bearing and line type).



Removing a Line

1. Position the screen cursor over the REMOVE LINE caption in the INDEX LINES menu.
2. Left click to access.
The caption in the menu will be displayed in yellow.
3. Within the video circle, position the video cursor over the line to be removed.
4. Left click to remove.
If required, steps 3 and 4 can be repeated on all lines in the group.

A further left click on the REMOVE LINE caption in the INDEX LINES menu will return the caption to its original colour and return editing to the 'edit by dragging mode'.



Removing ALL Lines

1. Position the screen cursor over the REMOVE ALL LINES caption in the INDEX LINES menu.
2. Left click to remove all lines.
A dialog box requesting confirmation will appear, see example left.
3. Within the dialog box, click on **ACCEPT** to remove all lines.

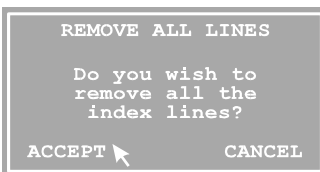

Saving a Group of Index Lines to a Memory Card

The group of index lines being edited can be saved at any time using the SAVE soft key.

1. Ensure the system is in Edit mode.
2. Position the screen cursor over the SAVE soft key under the INDEX LINES menu.
3. Left click to save.
A drop down alphanumeric keypad will be revealed from where a memory card and filename can be entered. Refer to Chapter 15.
4. Once saved the chosen filename will be displayed in the filename line.

If during an edit mode the group of lines has been edited but not saved then (Unsaved) will be displayed under the filename line.



Loading a Group of Index Lines from a Memory Card

The LOAD key allows a new group of Index Lines to be loaded from a memory card.

1. Position the screen cursor over the LOAD soft key under the INDEX LINES menu.
2. Left click to reveal a list of filenames available for loading from the selected memory card.
3. Position the screen cursor over the CARD n:line and left click to select Card A or B.
4. Position the screen cursor over the filename of the group of index lines you wish to load. The file selected will be highlighted. Use the scroll facility if required.
5. Left click to select. The filename of the group of Index Lines will then be displayed in the menu.



Unloading a Group of Index Lines

The UNLOAD key removes all index line data from the screen and the filename from the menu. This is useful to clear the system before creating a new group of index lines.

Exiting from Edit Mode

Edit mode can be exited either by a left click on the EDIT soft key or the EXIT INDEX LINES soft key.

On the EPA(L) and software versions up to 5.00 when an editing session is ended, all edited data is saved to the radars non-volatile memory.

From Software Version 5.01, the group of index lines must be saved to a memory card before exiting. If an attempt is made to exit from index lines when there are unsaved edits, the user will be prompted, in the form of a dialogue box to save the current edits before exiting.

Warning Prompt

If an attempt is made to edit or turn index lines ON when an invalid range is selected, the following prompt is displayed.

Invalid range for index lines

CHAPTER Tools 12

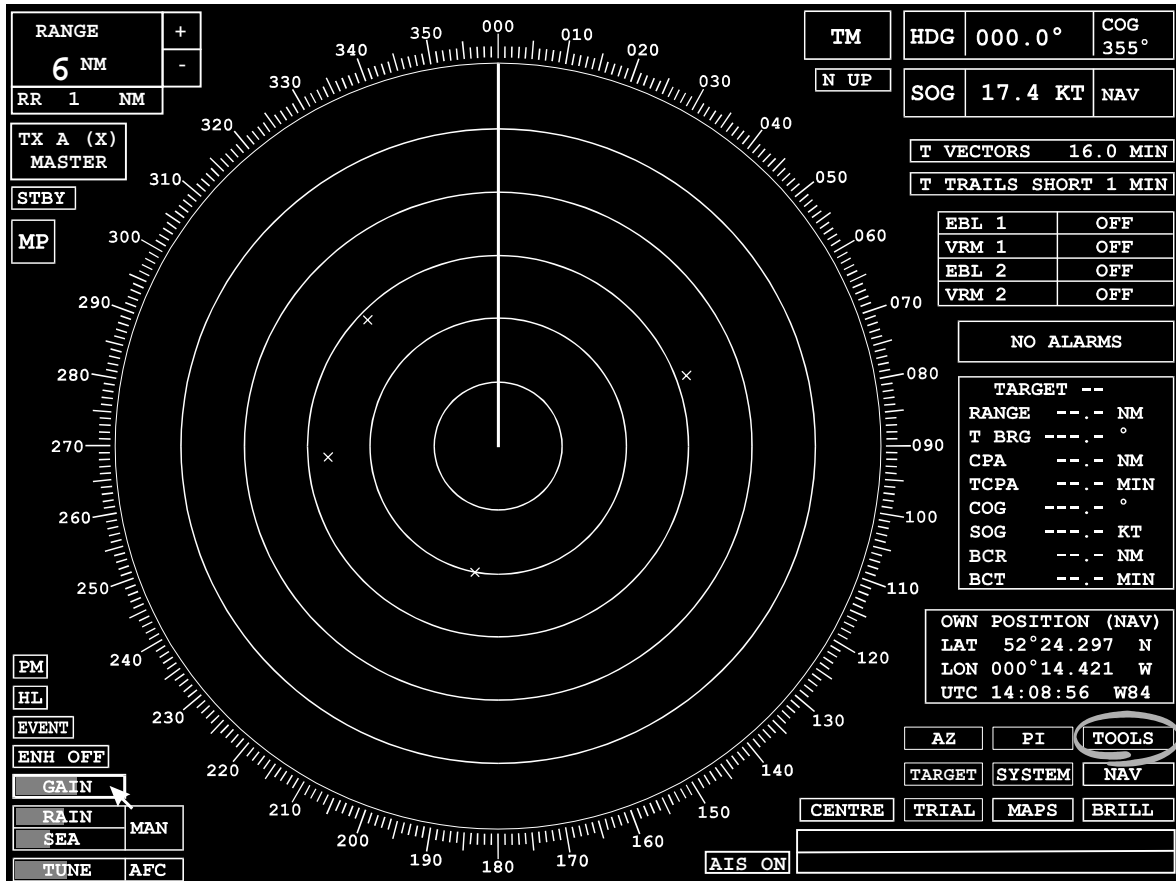

Covered in this chapter:

- Displaying a half circle or full circle rotating cursor to provide a means of parallel indexing.
- Marking points of interest in the video circle.
- Planning a change of course using a constant turn radius.
- Displaying an outline of own ship at its position in the video circle.
- Display of VMS graphics (Predicted Vector and Next Turn EBL)



Introduction

The **TOOLS** soft key provides access to a number of on-screen tools which allow the user to:

- Display a half or full circle 'Rotating Cursor'.
- 'Mark' up to 20 points of interest on screen.
- Pre-plan a 'Radius Turn'.
- Display the 'Ship's Profile'.

Accessing the TOOLS

1. Position the screen cursor over the **TOOLS** soft key.
The **TOOLS** soft key is only available in transmit.
2. Right click to toggle tools display **ON** or **OFF**.



Note – When tools are turned-**ON**, only the tools currently **ON** in the **TOOLS** menu will be visible. When tools are turned-**OFF** all tools related synthetics are removed from the radar picture.

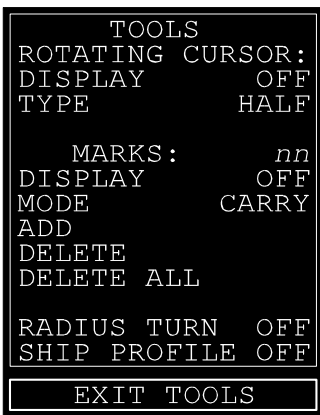

A left click will reveal the **TOOLS** menu and an **EXIT** soft key as shown on the left.

Note – A left click on the **EXIT TOOLS** soft key will close the menu.

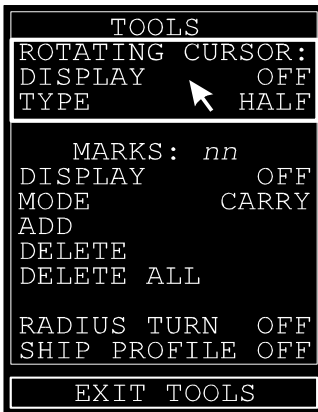

Rotating Cursor

A **HALF** circle, or **FULL** circle, rotating cursor can be displayed to provide a means of parallel indexing. The rotating cursor consists of a single white line diameter plus a number of equally spaced lines which are perpendicular to the single line. The spacing of the perpendicular lines corresponds to the range ring spacing on all ranges except the 0.75 nm (1.5km) range where spacing is at half ring intervals. The rotating cursor is always centred on own ship.

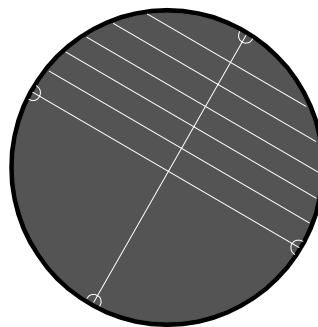

HALF Rotating Cursor

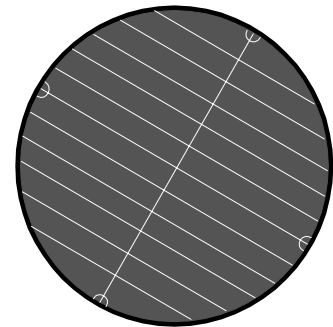

FULL Rotating Cursor

The displayed cursor can be rotated by dragging (left click, hold and drag) the end points of the lines which pass through the video circle centre. The end points are marked with an open semi-circular marker. ◡



To Turn the Rotating Cursor ON or OFF

1. Within the menu, position the screen cursor over the DISPLAY line under the ROTATING CURSOR heading.
2. Left click to toggle the cursor ON or OFF.



To Select HALF or FULL Circle Cursor

1. Within the menu, position the screen cursor over the TYPE line.
2. Left click to toggle the cursor to HALF or FULL.

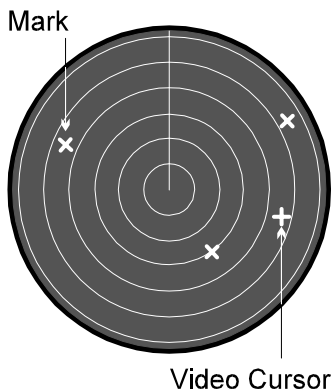
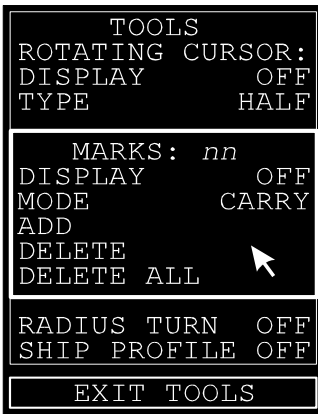

Marks

Up to 20 position 'marks' can be defined within the video circle. The marks are available in all stabilised motion modes and on all range scales, and may be '**dropped**' or '**carried**'. When carried, the marks remain at a fixed range and true bearing from own ship. When dropped they remain at a fixed position on the ground or in the water (depending on the speed mode in use).

In the menu the MARKS : *nn* line indicates the number of marks currently defined, and the MODE line indicates whether CARRY or DROP is selected.

To Turn Marks ON or OFF

1. Within the menu, position the screen cursor over the DISPLAY line under MARKS: *nn* heading.
2. Left click to toggle marks ON or OFF.

Marks are displayed as small white crosses (x) within the video circle.

To CARRY or DROP Marks

1. Within the menu, position the screen cursor over the MODE line.
2. Left click to toggle between DROP and CARRY.

To ADD Marks

1. Within the menu, position the screen cursor over the ADD line.
2. Left click to select. The ADD line in the menu will change to yellow.
3. Position the cursor over the position to be marked.
4. Left click to mark.

If an attempt is made to add a mark when 20 marks are already defined, the following prompt is displayed.

All marks are now allocated



To DELETE Individual Marks

1. Within the menu, position the screen cursor over the DELETE line.
2. Left click to select. The DELETE line in the menu will change to yellow.
3. Position the cursor over the mark to be deleted.
4. Left click to delete.

To DELETE ALL Marks

WARNING – THIS OPERATION CANNOT BE UNDONE.



1. Within the menu, position the screen cursor over the DELETE ALL line.
2. Left click to delete ALL marks.

Note – All ‘marks’ are *cleared automatically* if the Drop or Carry mode is altered, or the presentation mode is changed to Head Up (See Chapter 5: Presentation & Motion Modes).

VMS Graphics (ATA/ARPA only)

Note – This will only appear in the TOOLS menu if the NAV Input has been set up to accept the VMSG message type at initialisation. See ship’s manual Chapter 4.

This line is used to select whether VMS graphics are displayed in the radar circle. They are displayed in orange, and show the predicted vector (PV) and next turn EBL as sent from the VMS.



1. Within the menu, position the screen cursor over the VMS GRAPHICS line.
2. Left click to toggle between OFF and ON.

VMS graphics can be displayed when in transmit mode, provided that valid compass information is available. If no VMS messages are received for 10 seconds, a VMS GRAPHIC alarm will be raised.

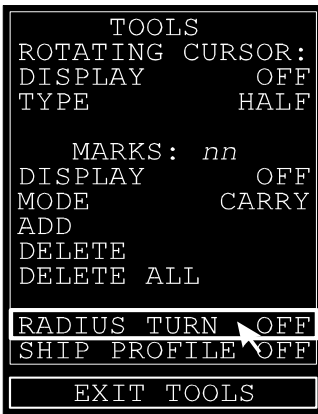

Constant Radius Turn

This tool allows the user to plan a change of course using a constant radius turn. It is available in transmit mode for all motion modes, stabilised presentation modes and range scales. The planned turn is displayed as three adjustable lines as shown in the figure below.

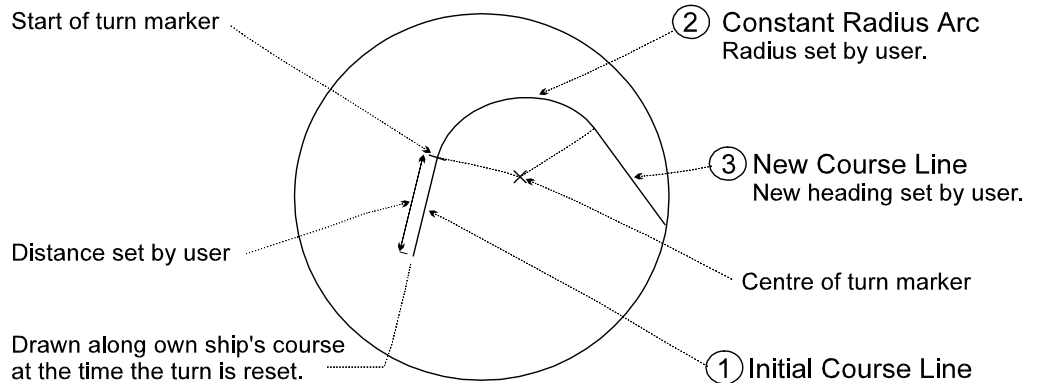

Radius Turn Menu

A left click on the RADIUS TURN line will reveal the RADIUS TURN menu shown below left.

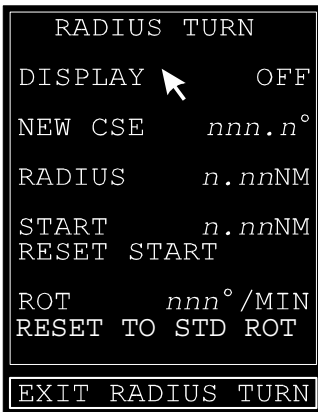

The planned turn is displayed initially with default values applied. Any adjustments made by the user are automatically limited to the maximum rate of turn.

The MAX RATE OF TURN is entered during initialisation.

Within the menu, left clicks on the DISPLAY line will toggle the 'radius turn' display ON and OFF.

Note – A left click on the EXIT RADIUS TURN soft key will close the menu.

Each parameter of the plan (new course, turn radius and start line) can be altered in any one of three ways.

1. By left clicking on the parameter caption in the RADIUS TURN menu, and then using the cursor control to change the reading.
2. By right clicking on the parameter caption in the RADIUS TURN menu to reveal a drop down numeric keypad, from which a new value for the parameter can be entered.
3. By a process of dragging from within the video circle (ONLY when the Constant Radius Turn menu is displayed and the Radius Turn Display is ON).

The procedures for making changes to individual parameters are as follows.

Setting the New Course

Either



1. Within the Radius Turn menu, position the screen cursor over the **NEW CSE** line.
2. Left click to allow adjustment using the cursor control.
3. Move the cursor control left or right to change the NEW CSE reading in the menu.
4. Left click to accept the new reading.

Alternatively a right click on the NEW CSE line within the menu will reveal a drop down numeric keypad from which the new course can be entered, see Chapter 15.

Or

From within the video circle,

1. Position the video circle over the **new course** line.
2. Press and hold down the left key.
3. Drag the new course line to the required course.
4. Release the left key.

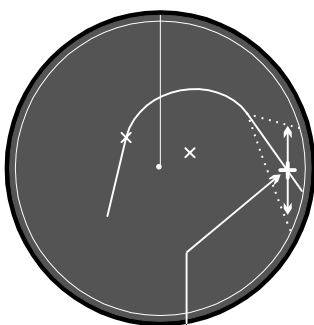

New course line
Drag to new course

Setting the Turn Radius

Either



1. Within the Radius Turn menu, position the screen cursor over the **RADIUS** line.
2. Left click to allow adjustment using the cursor control.
3. Move the cursor control left or right to change the RADIUS reading in the menu.
4. Left click to accept the new reading.

Alternatively a right click on the RADIUS line within the menu will reveal a drop down numeric keypad from which the radius can be entered, see Chapter 15.

Or

From within the video circle,

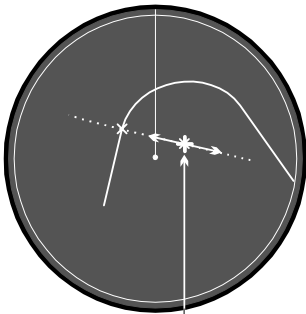

Centre of turn marker
Drag to adjust radius

1. Position the video cursor over the **centre of turn** marker.
2. Press and hold down the left key.
3. Drag the marker to adjust the turn radius.
4. Release the left key.

Setting the Start Line

Either



1. Within the Radius Turn menu, position the screen cursor over the **START** line.
2. Left click to allow adjustment using the cursor control.
3. Move the cursor control left or right to change the START reading in the menu.
4. Left click to accept the new reading.

Alternatively a right click on the START line within the menu will reveal a drop down numeric keypad from which the start can be entered, see Chapter 15.

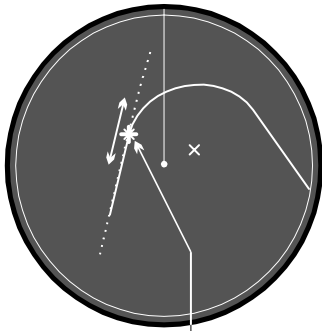

Start of turn marker
Drag to new point

Or

From within the video circle,

1. Position the video cursor over the **start of turn** marker.
2. Press and hold down the left key.
3. Drag the start of turn marker along the initial course line to the point required.
4. Release the left key.



Aligning to Own Ship's Course

After all parameters have been adjusted, the planned turn must be aligned with own ship's course.

1. Within the Radius Turn menu, position the screen cursor over the **RESET START** line.
2. Left click to place the start of turn marker on own ship's course line.

Rates of Turn

Within the Radius Turn menu, the 'rate of turn' (ROT) is calculated from the other parameters. See **Standard Rate of Turn**.



Standard Rate of Turn

1. Within the menu, position the screen cursor over the **RESET TO STD ROT** line.
2. Left click to reset the radius to that required for the standard rate of turn.

The standard rate of turn is entered during initialisation.

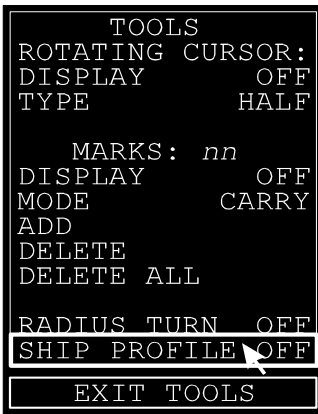

Ship's Profile

This tool allows the ship's profile (a simple outline of the ship in plan view) to be displayed at own ship's position in the video circle. The profile is displayed in Transmit mode only, and does not apply to static installations. The profile is only shown on the lower range scales.

1. Within the **TOOLS** menu, position the screen cursor over the **SHIP PROFILE** line.
2. Left click to toggle the profile display **OFF** or **ON**.
The default setting for Ship's Profile is ON.

Note – *The shape of the profile and maximum range scale at which it is displayed is determined from information entered during initialisation (ie Ship's length and beam, and Turning Unit offsets from ship's centre).*

CHAPTER Alarms 13

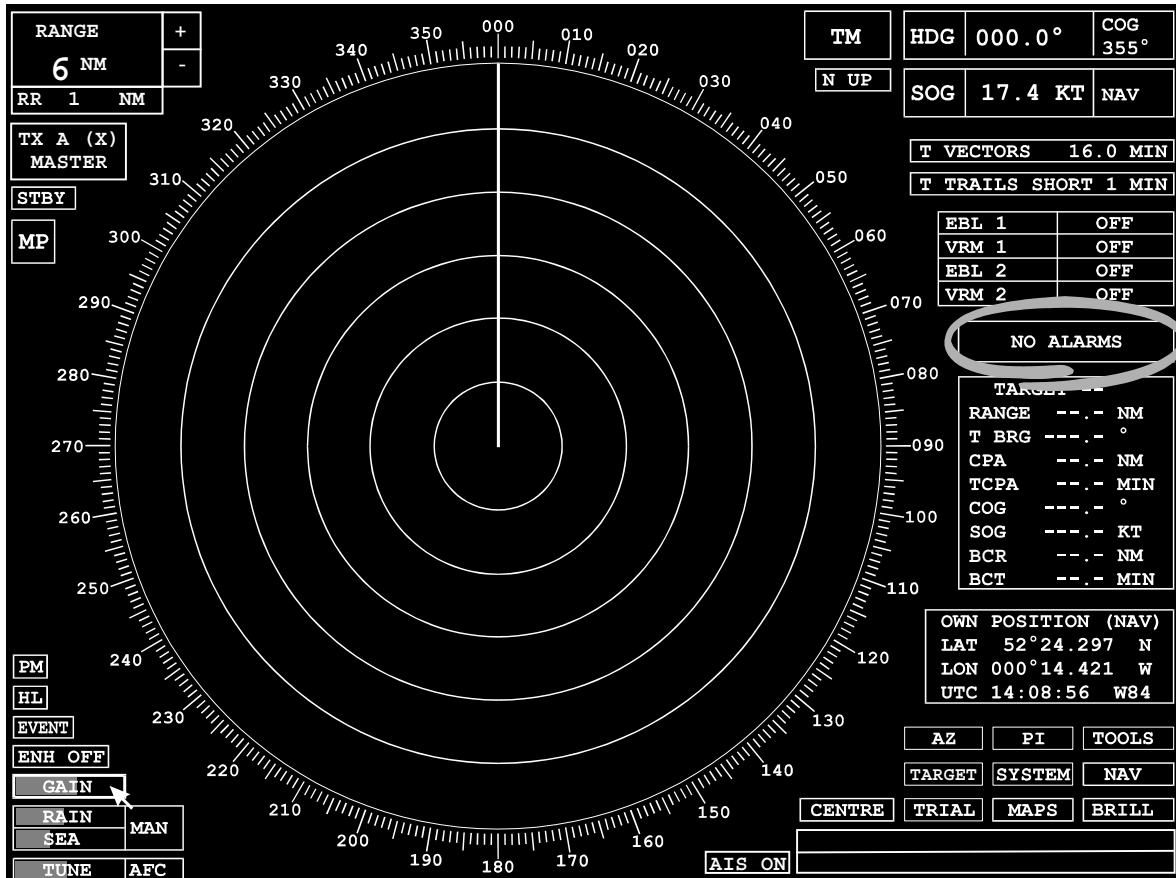

Covered in this chapter:

- The alarm states.
- Acknowledging an alarm.
- Viewing acknowledged alarms in order of priority.
- Determining whether a buzzer is sounded for each new alarm.
- Setting up a watch alarm to detect if there has been no operator activity on the radar for a specified period.
- A list of the alarms which can be raised by the system and any remedial action which should be taken.



Introduction

Alarms are displayed at the right side of the video circle in the Alarms display box which is present in both Standby and Transmit modes. A list of Alarms, together with a brief description and suggested remedial actions for each alarm, is given at the end of the chapter.

Types of Alarm

There are three types of alarm.

- Those which will clear automatically when the condition that caused the alarm is no longer present.
For example, Bow Crossing, CPA/TCPA and Position alarms.
- Those which will clear as soon as they are acknowledged even if the condition that caused the alarm is still present.
For example, Guard Line and AZ Entry alarms.
- Those which will clear **ONLY** when the alarm has been acknowledge **AND** the condition that caused the alarm is no longer present.
For example, Compass, TX COMMS and TX BIST.

Alarm Display

The Alarm display box provides an indication of the current alarm state and a means of acknowledging alarms, should any occur. There are three alarm states:

- No Alarms
- Unacknowledged Alarms
- Acknowledged Alarms



No Alarms

If there are no alarms the caption **NO ALARMS** is displayed in **GREEN**.



Unacknowledged Alarms

When an alarm condition is detected, that alarm flashes **RED** in the Alarm display box. If more than one alarm conditions exists, the alarm with the highest priority is displayed. The alarm remains displayed until it is either acknowledged, automatically cleared, or is replaced with an alarm of higher priority.

If the internal buzzer is enabled (see **Alarm Facilities** below), this will only sound when there are unacknowledged alarms. If, in addition, a Remote Alarm output is available, this will be active only when the alarms selected for use are unacknowledged. See Ship's Manual Chapter 4 'Remote Alarm' for details.



To Acknowledge an Alarm

1. Position the screen cursor over the Alarm display box.
2. Left click to acknowledge.

If there is more than one alarm, the acknowledged alarm is replaced by the next HIGHEST priority unacknowledged alarm.

3. Repeat the process until all alarms have been acknowledged. When there are no further unacknowledged alarms, the caption ALARMS is displayed in **RED** and is steady (ie is not flashing).



Acknowledged Alarms

If there are acknowledged alarms but NO unacknowledged alarms the caption ALARMS is displayed in **RED** and is steady.

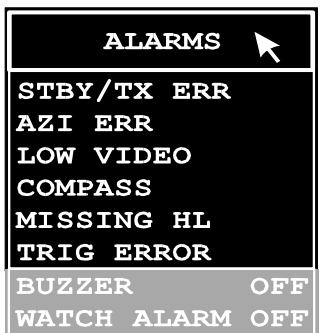

Alarm Facilities

A right click on the Alarm display box reveals a drop down list of up to six acknowledged alarms, arranged in order of priority and a drop down alarm menu.

Note – When required, use a right click to exit and remove the list.

The Alarm menu offers two independent options,
BUZZER When this is switched-ON, a beep sounds for each new alarm.
WATCH ALARM When this is switched-ON, a beep is sounded to alert the officer of the watch if no operator activity has been detected for a set period of time.

Note – *The two alarms are independent of each other. A WATCH alarm will be sounded even if the BUZZER alarm is switched-OFF.*

The Alarm BUZZER

To turn the alarm BUZZER ON or OFF,

1. Within the drop down menu, position the screen cursor over the BUZZER line.
2. Left click to toggle the buzzer ON or OFF.
3. Right click to close the menu.



To Set the Watch Alarm Interval

1. Position the screen cursor over the **watch alarm** line.
2. Left click to cycle through the available time intervals. The interval can be set to 3,6, 9 or 12 minutes, or OFF.
3. When the time interval required is displayed, right click to accept the interval and close the menu.



List of Alarms

The alarms which are raised by the system, and appear in the ALARM box at the right hand side of the display, are given in alphabetical order in the table below. If more than one alarm exists, the alarm with the highest priority (the most important) is displayed.

Alarm Message	Brief Description/Remedial Actions
AIS INPUT	No messages on AIS input. Check sensor and wiring.
AIS INTEGRITY	Alarm message received from the AIS. Check sensor.
ALARM INPUT	Input failure from Central Alarm Management System.
APPROACH	Waypoint Approach Limit reached.
AUTOTIDE	Nav speed not valid. Check input.
AZ ENTRY	Target detected entering acquisition zone.
AZ OVERLOAD	Acquisition zone overloaded. Reduce size of zone or re-position.
AZI ERROR	Wrong number of azimuths detected. SYSTEM menu, TEST DATA.
BOW CROSS	Limit reached. Check limits – left click BCR or BCT line in TOTE.
CARD BATTERY	Replace battery on memory card. Refer to Ship's Manual.
CARD FULL	A memory card has only 2K bytes free left. Delete some unused files.
CHECKSUM	Error detected in file on memory card.
COMPASS	Compass Alarm. Check wiring and SYSTEM menu – TEST DATA.
CONTROL PANEL	Check joystick or trackerball connections.
CPA/TCPA	Limit reached. Check limits – left click on CPA or TCPA line in TOTE.
DEPTH INPUT	Input has failed. Check sensor and wiring.
DISPLAY RESET	System has restarted – processor fault.
EXTERNAL MAP	Communication failure on NAV line interface.
GPS QUALITY	Quality of GPS signals degraded. Check external GPS input.
GRAPHICS RESET	System has restarted – processor fault.
GUARD LINE	Own ship has crossed a guard line. MAPS soft key.
GZ ENTRY	EPA only. Target detected in guard zone.
INTERN STORAGE	Error in internal map storage. EPA(L) only.
INTERSWITCH	NOT communicating correctly. Check for correct wiring.
LEG CHANGE	New leg has defaulted to RHL. NAV menu – ROUTE to select GC.
LOG ERROR	NO pulses or NO serial input. Check TYPE selected and wiring.
LOST REF	ECHO REF target lost. Select new target or different speed source.
LOST TARGET	Tracked target no longer detected.
LOW VIDEO	Reset video input level. SYSTEM menu – TX SETTINGS.
MEMORY	Memory device has failed.
MISSING HL	Missing Heading Marker
MISSING SL	Missing Stern Marker
MOTION MODE	Forced motion mode change due to new range or compass alarm.
MVR TIME	Manoeuvre time has expired.
NAV INPUT	Serial input has failed. Check sensor and wiring.
NAV SPEED	Alarm condition or NO messages. Check sensor.
NO SCAN HL	Scanner NOT rotating – System forced to STANDBY.
OFF TRACK	Cross Track Error limit reached.
PC CARD	PC CARD removed or write-protected. SYSTEM menu – MEMORY CARD – CARD STATUS.

Alarm Message	Brief Description/Remedial Actions
PL ERROR	Pulse length sent to transceiver does not match pulse length returned.
PLOT UPDATE	EPA only. More than 10 minutes since last plot made – see Flashing ID.
POSITION	Lat/Lon Position or Compass alarm for 1 minute.
PROCESSOR	Radar Processor communications failure.
RADAR RESET	System has restarted – Processor fault.
ROUTE ERROR	Error in internal route data on PC card.
STBY/TX ERR	Transceiver failed to go to transmit or standby.
TEMPERATURE	TOO high – clean filter, check fan is running.
TM RESET	Picture about to reset. Left click on TM to change to RM(T)
TRACKS FULL	Tracking maximum number of targets – cancel some.
TRIG ERROR	NO triggers – check connections.
TX BIST	Check SYSTEM menu – TEST DATA – TX BIST.
TX COMMS	No serial communication from transceiver.
VISION	Vision failure or configuration error. Check system status menu.
VMS GRAPHIC	Communication failure with the VMS system.
WATCH ALARM	NO control panel activity for pre-set limit. ALARMS menu.
WIND INPUT	Input has failed. Check sensor and wiring.
ZONES FULL	EPA only. 60 violations detected – move zone.

When the following alarm message is displayed inside the video circle all video information within the video circle is blanked.

Alarm Message	Brief Description/Remedial Actions
SYSTEM FAILURE PLEASE RESTART	Graphics processor communication failure. System must be restarted in order to clear the alarm.

When the following alarm message is displayed inside the video circle the commissioning settings for the display and transceiver must be re-entered.

Alarm Message	Brief Description/Remedial Actions
WARNING – RADAR REQUIRES RE- COMMISSIONING	System non-volatile memory has been reset. Re-enter all commissioning values as stored in the Ships Manual.

CHAPTER System 14

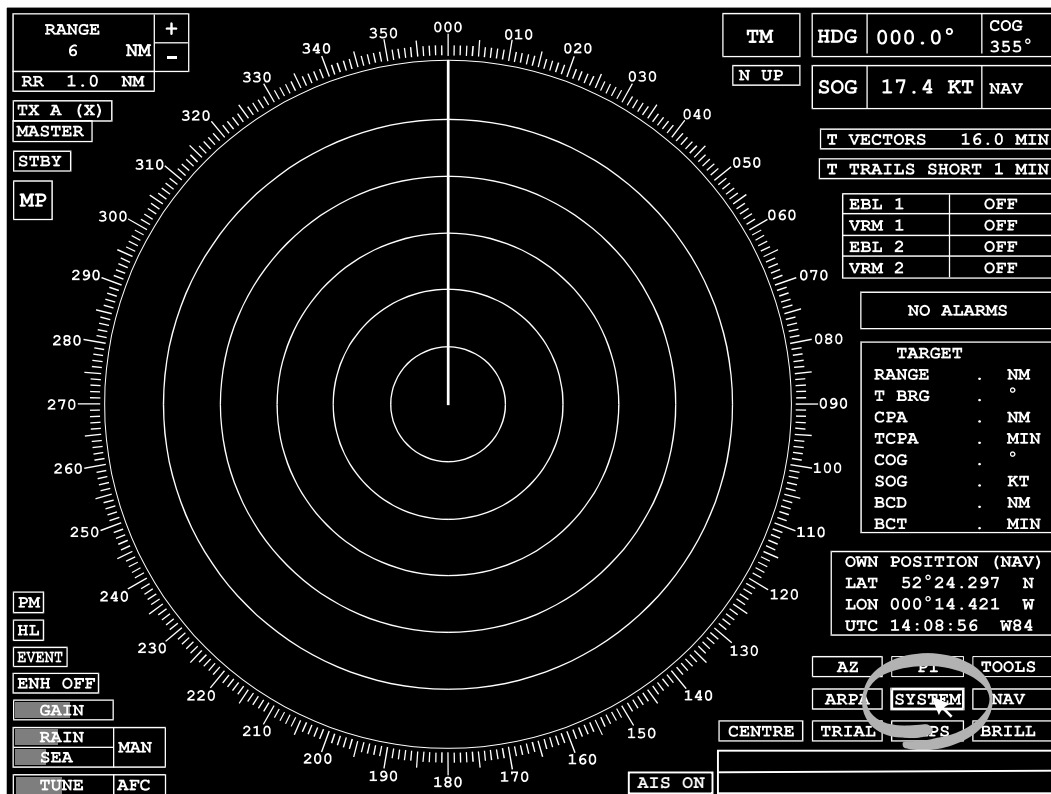

Covered in this chapter:

- Degaussing the monitor.
- Memory card status, initialisation and management.
- Viewing the video processing settings.
- Viewing the transceiver operating parameters.
- Viewing the current status of system technical parameters.
- Monitoring system performance.
- Viewing test data, transceiver status and BIST.

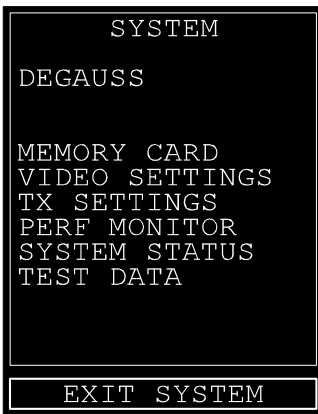

Introduction

The **SYSTEM** soft key provides a means of access to a number of additional system facilities. Many of these facilities are provided for maintenance and diagnostic purposes only and are, therefore, not intended to be used by the radar operator but by maintenance personnel.

Accessing the SYSTEM Facilities

1. Position the screen cursor over the SYSTEM soft key.
2. Left click to reveal the SYSTEM menu shown on the left.

The facilities listed below can be accessed from the menu.

DEGAUSS	Degaussing the radar monitor.
MEMORY CARD	Monitoring the status of the internal memory cards and management of the data stored on them. (Not available on EPA(L))
VIDEO SETTINGS	Viewing the settings of the video processing parameters.
TX SETTINGS	Viewing the settings of the transceiver operating parameters.
PERF MONITOR	Setting up the performance monitor during commissioning. (This facility is password protected).
SYSTEM STATUS	Viewing system status details.
TEST DATA	Monitoring system hardware performance.

Note – A left click on the **EXIT SYSTEM** soft key, will close the menu and exit the system facilities.

Degaussing

This line will not be operational and may not be displayed if the monitor type is an LCD.

The Radar monitor is degaussed automatically one minute after power-up. After this initial degaussing, a fresh degauss can be selected from the SYSTEM menu.



To Degauss the Radar Monitor

1. Position the screen cursor over the DEGAUSS option in the SYSTEM menu.
2. Left click to initiate degauss.
The word **INHIBITED** will be displayed for a period of 30 seconds during which time further selection is prevented.

Memory Card Facilities (Not on EPA(L))

Management of the internal memory cards is carried out using a number of file handling and data transfer options.

The system is fitted with two memory card slots identified as CARD A and CARD B. See **Memory Cards**, Chapter 15 for more information.

Accessing the Memory Card Facilities

1. Within the SYSTEM menu, position the screen cursor over the MEMORY CARD option.
2. Left click to reveal the MEMORY CARD menu shown on the left.

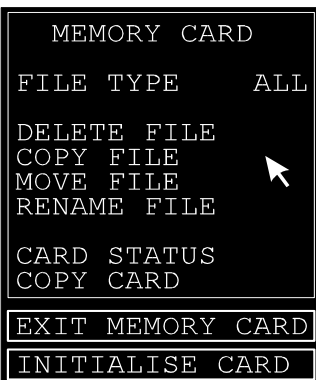

Note – In addition to the menu, *EXIT* and *INITIALISE* soft keys are also displayed. A left click on the *EXIT MEMORY CARD* soft key, will close the menu and exit the memory card facilities.

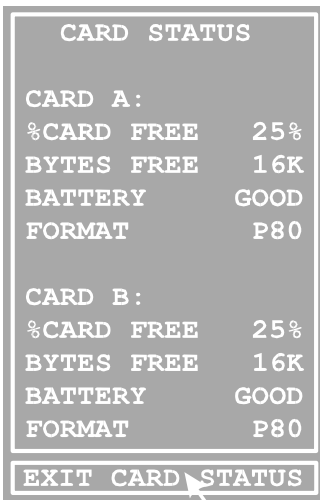

Card STATUS

1. Within the MEMORY CARD menu, position the screen cursor over the CARD STATUS caption.
2. Left click to reveal the CARD STATUS menu shown on the left.

Note – This data displayed in this menu is for information ONLY and cannot be changed.

3. Left click on the EXIT CARD STATUS soft key (under the STATUS menu) to return to the MEMORY CARD menu.

File Management

Files can be selected by **TYPE** (Maps, Folios, ALL etc). Once the file 'type' has been selected, files can be deleted, copied, moved or renamed by selecting the appropriate option from the MEMORY CARD menu. When any of these options is selected, a drop down menu is displayed listing all files of the type selected, see example left.



Whenever this menu is displayed, the following conditions apply.

- A left click on the CARD *n*: caption at the top of the menu, will toggle between Card A and Card B.
- A left click on a listed file will replace the list with a dialog box requiring confirmation of the selected option.
- A right click at any time will remove the list of dialog box without taking further action.

Selecting a FILE TYPE

From within the MEMORY CARD menu, left click repeatedly on the FILE TYPE option to cycle through the file types available.

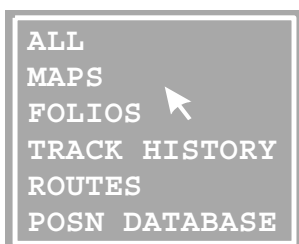

Note – A right click will reveal the drop down menu shown on the left which lists the file types available. Left click on the type required.



Deleting a File

1. Within the MEMORY CARD menu, left click on the DELETE FILE option to reveal a drop down menu listing all files of the 'type' selected.
See File Management.
2. Left click on the file to be deleted.
This will replace the list with the dialog box shown on the left.
3. Left click on YES to delete the selected file.
Or
Left click on NO or right click to close the dialog box without taking further action.

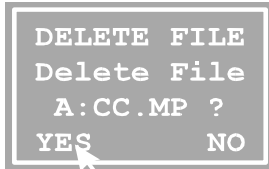

Copying a File

1. Within the MEMORY CARD menu, left click on the COPY FILE option to reveal a drop down menu listing all files on the 'type' selected.
See File Management.
2. Left click on the file to be copied.
This will replace the list with the dialog box shown on the left.
3. Left click on YES to copy the selected file.
Or
Left click on NO or right click to close the dialog box without taking further action.

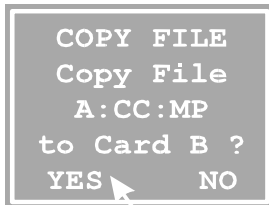

Moving a File

1. Within the MEMORY CARD menu, left click on the MOVE FILE option to reveal a drop down menu listing all files of the 'type' selected.
2. Left click on the file to be moved.
This will replace the list with the dialog box shown on the left.
3. Left click on YES to move the selected file.
Or
Left click on NO or right click to close the dialog box without taking further action.

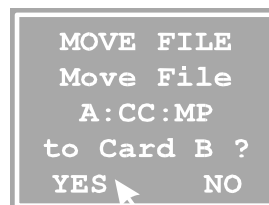



Renaming a File

1. Within the MEMORY CARD menu, left click on the RENAME FILE option to reveal a drop down menu listing all files of the 'type' selected. See **File Management**.
2. Left click on the file to be renamed. This will reveal a drop down alphanumeric keypad labeled 'RENAME FILE'. Alphanumeric keypads and their use are described in Chapter 15.
3. Use the keypad to enter the new filename, or right click to cancel. When a new filename has been entered, the dialog box shown on the left is displayed (the file names shown are for example only).
4. Left click on YES to rename the selected file.
Or
Left click on NO or right click to close the dialog box without taking further action.

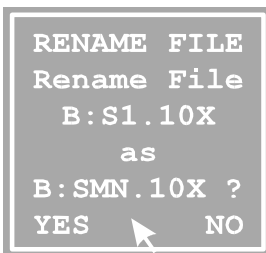

Note – If the selected filename already exists on the destination card, the choice is given of overwriting the existing file or of canceling the copy, move and rename function.

Note – If the selected file is in use (eg: a map) then the delete, move and rename functions will not work and a brief prompt 'File in Use' will be displayed.

Note – If the memory card is write-protected, then the delete, move and rename functions will not work and a brief prompt 'Card Write Protected' will be displayed.



To Copy all the files from one Card to the Other

1. Within the MEMORY CARD menu, position the screen cursor over the COPY CARD option.
2. Left click to reveal the dialog box shown below.

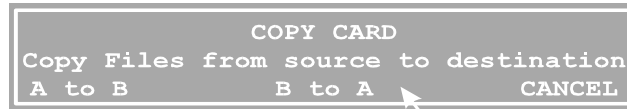

3. Position the screen cursor over the 'A to B' or 'B to A' caption to select the direction of copy required.
4. Left click to transfer the files from one card to the other. If any of the filenames being copied already exists on the destination card, the option to overwrite or cancel the transfer is given.

Note – A left click on the CANCEL caption will abort the copy operation. A temporary prompt 'Copying card' is briefly displayed at the start of copying. When copying is complete, which can take up to 30 seconds, the prompt 'Card copy completed' is briefly displayed. Cards must **NOT** be removed until the 'Card copy completed' prompt has been displayed.

To Initialise a Card

The INITIALISE CARD soft key under the MEMORY CARD menu is used to erase the contents of a card.



WARNING - THIS OPERATION WILL DELETE EVERYTHING ON THE CARD.



1. Position the screen cursor over the INITIALISE CARD soft key.
2. Left click to reveal the dialog box shown below.



3. Position the screen cursor over the A or B caption to select Card A or Card B as required.
4. Left click to initialise the selected card.

Note – A left click on the CANCEL caption will abort the initialisation.

Additional Facilities

The following facilities (some of which are password protected) are used for setting up and monitoring the system. They also provide a useful diagnostic aid for locating system faults. Each facility, outlined only briefly below, is described in more detail in the Ship's Manual.



WARNING - VESSEL SAFETY MY BE COMPROMISED BY UNAUTHORISED CHANGES TO ANY OF THE FOLLOWING.

Video Setting Facilities



VIDEO SETTINGS

The video processing parameters are set up during commissioning (see Ship's Manual, Chapter 4) and once set are not normally altered. The current settings can be viewed in the VIDEO SETTINGS menu.

TX Setting Facilities



TX SETTINGS

The operating parameters for selected transceivers are set up during commissioning (see Ship's Manual, Chapter 4) and once set are not normally altered. The current settings can be viewed in the TX SETTINGS menu. The menu is used for the input of initial settings and any subsequent changes, BUT requires a password for changes.

Performance Monitor



PERF MONITOR

This facility is used during system commissioning for setting up the performance monitor BUT requires a password for access.

System Status Display



SYSTEM STATUS

The SYSTEM STATUS menu gives an indication of the system status, including software versions, hardware configuration and running times.

Test Data Facilities



TEST DATA

The test data facilities provide the means of monitoring system inputs including compass, log as well as transceiver inputs for azimuth, PRF and heading marker. Other soft keys provide access to Transceiver Status and the results of Built In Self Test (BIST) data for the transceiver hardware.

CHAPTER References

15

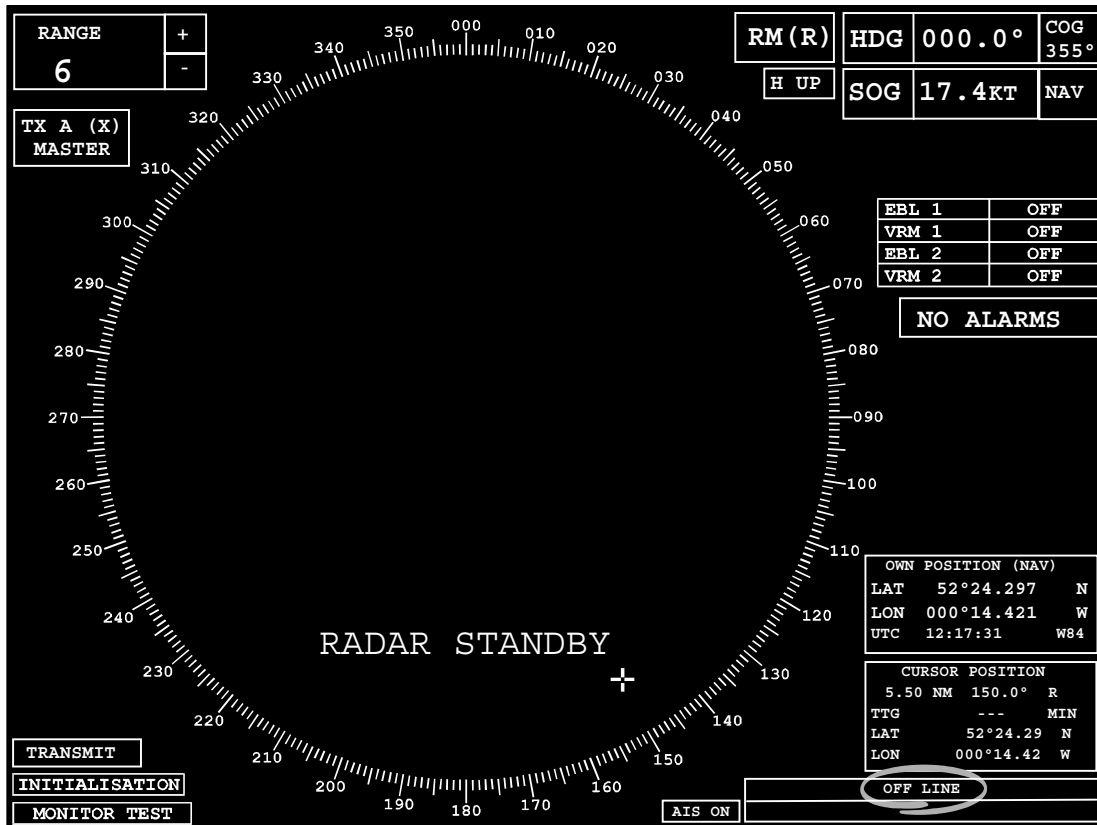

Covered in this chapter:

- Drop down menus and keypads.
- Memory cards and their function.
- Help line warning prompts and their interpretation.
- List of warning prompts.

Introduction

This chapter gives more detailed information on topics such as drop down menus and keypads, and memory card functions, which are encountered at various points throughout the manual. You don't need to spend too much time initially becoming familiar with these topics, as you will be referred to this chapter when necessary. An alphabetical list of warning prompts is also included.

Drop Down Menus

A drop down menu is usually displayed in the vicinity of the screen cursor when the selection is made. Once a menu is displayed, the cursor is restricted to the area within the menu and selections are made with a left click. A right click will close the menu without taking further action (ie Cancel).

In some instances a drop down menu may contain a list of filenames or other data. If the list is too long to be displayed within the menu area, a scroll bar is displayed at the right hand side of the menu, see below.

Selecting an Item from a Scrolled List

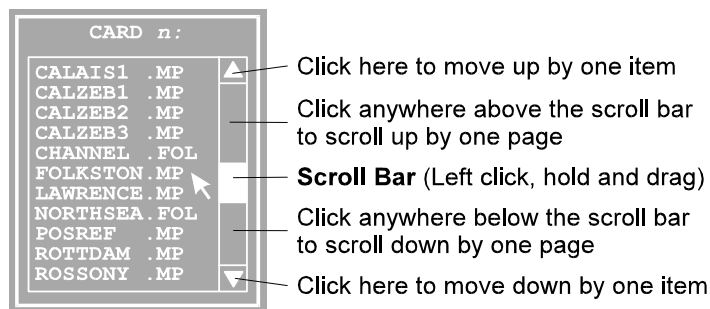

1. Items in the list are highlighted as the cursor passes over them. Use the cursor to highlight the item required.
2. Left click to select (the menu is closed automatically), or right click to close the menu without making a selection.

Drop Down Keypads

Where the input of a variable parameter or filename is required, a right click will reveal a drop down numeric or alphanumeric keypad, see examples below. All keypads have a similar format and are used in the same way.

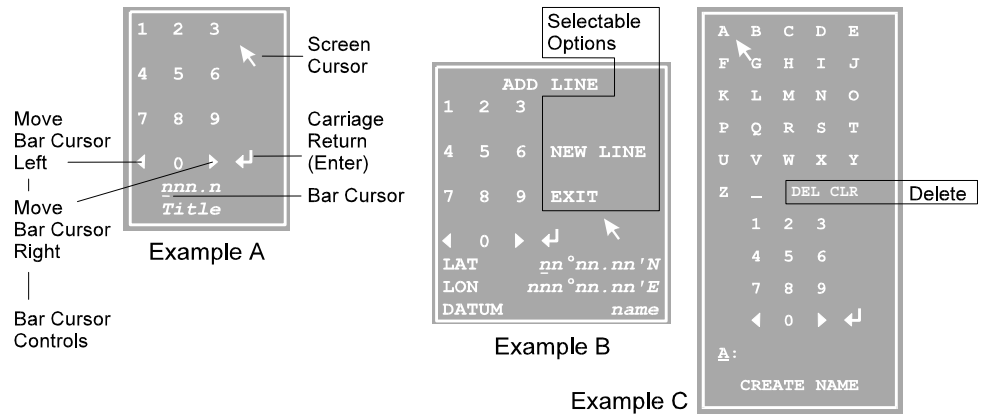

Numeric Keypads

Examples A and B above are of typical numeric keypads. The parameter(s) to be entered are shown in italics (*n*'s). When the keypad is initially displayed, a small bar cursor is positioned under the first (left hand) digit in the parameter. This cursor indicates where the next digit entered will be placed.

Entering a Parameter Value

1. Position the screen cursor over the first digit required (from 0 to 9).
2. Left click to select.
The digit will appear in the appropriate position and the bar cursor will move right by one position.
3. Repeat steps 1 and 2 until all digits of the parameter have been entered.
Where the parameter is a latitude or longitude (qualified by a letter N or S, E or W) a left click on the displayed letter will toggle it to the alternative.
4. Position the screen cursor over the carriage return symbol.
5. Left click to enter the parameter.

If an entered value is outside the acceptable limits for the selected parameter, the keypad will remain open for a new input.

Correcting a Wrong Selection

If an incorrect digit is entered.

1. Left click on the left or right bar-cursor control symbols (left and right facing arrowheads) to position the bar cursor under the digit to be changed.
2. Position the screen cursor over the correct digit (from 0 to 9).
3. Left click to select.

Entering a Negative Value

Where a particular parameter can be a positive or negative value, a +/- symbol will be included in the keypad.

1. Position the screen cursor over the +/- symbol.
2. Left click to toggle between + (positive) or – (negative).
A negative selection is indicated by a negative sign (-) in front of the parameter. A positive selection is indicated by the absence of the negative sign.

Closing the Keypad

When a keypad is displayed, a right click will close the keypad without taking further action leaving the old value. For most numeric keypads, a left click on the carriage return symbol will enter the parameter and close the keypad. However, where multiple entries can be made, like defining lines or symbols on a map, the keypad is held open. In such cases and EXIT caption is included in the keypad. To close this type of keypad either right click as explained earlier, or left click on the EXIT caption.

Memory Cards

Your radar system may be fitted with a memory card reader and two memory card slots identified as CARD A and CARD B. Each system is supplied with one memory card. All cards are fitted with a battery for maintaining data when the primary power source is switched-OFF. Some cards have internal rechargeable batteries rather than removable plug-in batteries. Most cards have a write protect switch to protect data, normally this switch is left in the non-protected position. (**IMPORTANT** – See *Ship's Manual, Chapter 7 'Routine Maintenance'*, for details of memory card battery maintenance).

When required, data can be moved between memory cards using the memory card menu. For certain functions, data can be loaded from a memory card into the system. Files are saved with a date and time stamp which is updated each time the file is written to. However, the date stamp will only be valid if a date message is being received from a nav sensor, or if the operator has correctly entered the date (under NAV soft key).

Filenames and Alphanumeric Keypads

The method used for entering a filename is much the same as that described earlier for entering a parameter value, except that in this case a mixture of letters and numbers can be entered. See **Drop Down Keypads** earlier in the chapter.

Example C, given earlier, shows a typical alphanumeric keypad for the input of a filename and an indication of where the file is to be saved. At the bottom of the keypad is the line **A:** (immediately above the CREATE NAME caption) with a small bar cursor under the first (left hand) character position. This character, immediately before the colon, is for identification of the memory card (A or B) on which the file is to be saved.

The space to the right of the colon is for the input of an 8-character filename under which the file will be saved. The filename can consist of a mixture of alphanumeric characters. The file extension is pre-determined and cannot be changed.

The DEL caption in the menu is used for deleting single characters at the underbar location. The CLR caption is used for clearing the entire filename.

Memory Card Functions

In the chapters of the User Guide, specific memory functions are explained as they arise within the chapter. However, a general summary of the basic SAVE and DELETE functions is given below.

See also **Memory Card Facilities** in Chapter 14.

SAVE

SAVE

The SAVE soft key, when encountered, allows the user to save a file to a memory card.

During and after the save operation, one or more of the following self-explanatory prompts may be displayed.

Save completed

Card not present

Card write protected

Card full

DELETE

DELETE

A DELETE soft key selects a drop down menu containing a list of filenames. See **Drop Down Menus** earlier in the chapter.

A left click on the DELETE soft key will reveal a YES/NO dialog box. A left click on YES will delete the highlighted file unless one of the warning prompts shown below is displayed.

Card not present

Card write protected

ERROR

If an invalid, uninitialised card or the memory card is faulty one of the following warning prompts will be displayed.

Card error

Card not formatted

To remove this problem the card must be re-initialised.

If a file on a card has an error when accessed one of the following warning prompts will be displayed.

Bad file format

Invalid file name

File checksum error

In these cases it will be necessary to delete the file being accessed.

Write Protect Switch

The following diagrams show the position of the write protect switch on the edge of the memory card.

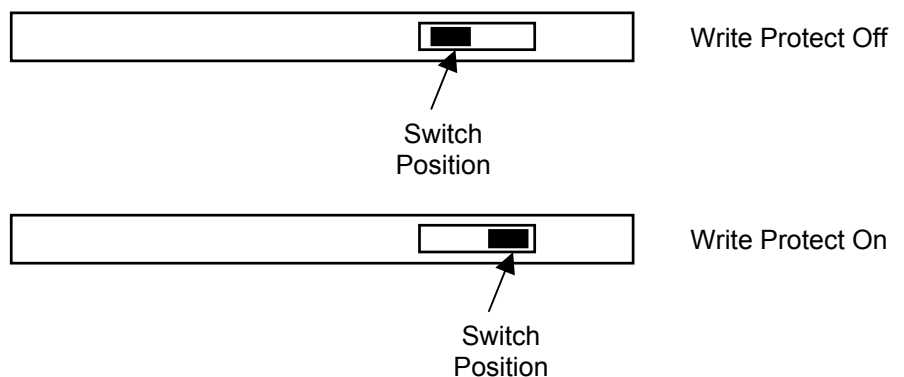

To switch between the modes simply move the slider from one position to the other.

Help Line Warning Prompts

A help area consisting of two lines of yellow text is given in the bottom right hand corner of the display.

```
This line is used for PERMANENT PROMPTS  
This line is used for TEMPORARY PROMPTS
```

This area is used to provide prompt information when, for instance, the user is trying to make a selection which conflicts with the existing set up. The prompts are by nature brief but are generally self-explanatory. Permanent prompts, when they exist, are displayed on the upper of the two lines. Temporary prompts are displayed on the lower line.

A selection of prompts encountered in the User Guide are assembled here to form a quick reference section. The chapter in which each prompt arises is also identified.

Selected List of Warning Prompts

```
All guard lines are defined
```

The maximum number of guard lines (20) has already been defined.
(Chapter 10)

```
All marks are now allocated
```

The maximum number of marks (20) have already been defined. (Chapter 12)

```
Cannot cancel echo ref target
```

You're trying to cancel a target which is selected as the echo reference.
(Chapter 4)

```
Cannot play while recording
```

A track history file cannot be played if one is presently being recorded.
(Chapter 9)

```
Cannot record while playing
```

A track history file cannot be recorded if one is presently being played.
(Chapter 9)

```
Card full
```

The memory card you've selected is nearly full (2 kilobytes remaining).
(Chapter 15)

The memory card you've selected is not there. (Chapter 15)

Card not present

The memory card you've selected is write protected. (Chapter 15)

Card write protected

You can't select a stabilised presentation mode because there is a compass alarm. (Chapter 5)

Compass error - H UP only

You can't select a true motion mode because there is a compass alarm. (Chapter 5)

Compass error - rel motion only

You can't plot or acquire a target because the compass heading is invalid. (Chapter 7)

Compass heading not valid

EBL2 origin exceeds own ship's origin by five screen radii. (Chapter 6)

EBL 2 and VRM 2 re-centred

The EPA(L) plotting synthetics are turned OFF. (Chapter 2)

EPA data off

Own ship's lat/long is outside permitted limits. (Chapter 3)

Invalid latitude

The selected range is too low for Enhanced Video mode operation. (Chapter 3)

Invalid range for enhanced mode

The range scale selected is too low for display of Index Line. They will be restored when a higher range is selected. (Chapter 11)

Invalid range for index lines

The selected range scale is either too low or too high for target plotting. (Chapter 7)

Invalid plot range

The selected range scale is too low for Relative Motion – True Trails (RM(T)) mode. (Chapter 5)

Invalid range for RM(T)

Invalid range for TM

The selected range scale is either too low or too high for True Motion (TM) mode. (Chapter 5)

Invalid range for zones

The selected range scale is too low or too high for displaying Guard Zones or Auto Acquisition Zones. (Chapter 7)

Invalid target range

The selected range scale is either too low or too high for target tracking. (Chapter 7)

In Edit mode

System is in Edit mode and some features will not be available. (Chapter 2)

Map has not been selected

You must first select the map you wish to edit. (Chapter 10)

Master in standby

You can't set a slave radar to 'Transmit' while the master radar is in 'Standby' mode. (Chapter 2)

Must align compass first

The compass must be aligned before you can enter a stabilised presentation mode. (Chapter 5)

Not available when AIS is on

MANUAL and ECHO REF speed modes and MANUAL set and drift cannot be used in AIS mode. (Chapter 4)

OFF LINE

The radar is in 'Standby' mode (ie Off-Line and not transmitting). (Chapter 2)

Own ship lat/lon not available

The display you've selected can't be switched on because there is a nav position alarm. (Chapter 10)

Past position REL 2 min

The selected time interval for the display of past positions is as indicated, eg 2 minutes in the example left. (Chapter 8)

Plot distance too big

The calculated velocity for a plot is greater than 150kts. (Chapter 7)

The plot you're trying to cancel can't be found. (Chapter 7)

Plot not found

MANUAL and ECHO REF speed modes and MANUAL set and drift cannot be used in AIS mode. (Chapter 4)

Not available when AIS is on

The 'Save' operation you initiated has been successfully completed. (Chapter 10)

Save completed

Indicates the type and location of the selected transceiver in the current configuration. (Chapter 3)

S-Band FWD

Sector blanking is automatically inhibited while the 'Performance Monitor' dialog is displayed. (Chapter 3)

Sector blanking inhibited

MAPS and ROUTES are unavailable in an unstabilised mode. (Chapter 9 &10)

Select stabilized mode

The selected range scale is inappropriate for the display of maps or track history. (Chapter 9 & 10)

Select a valid range

The ARPA, ATA or EPA synthetics are turned OFF. (Chapter 2)

Target display off

The target you're trying to select for track history on target repair can't be found. (Chapter 8 or 9)

Target not found

Indicates the type and location of the selected transceiver in the current configuration. (Chapter 3)

X-Band AFT STBD

Intentionally Blank

Search and Rescue (SART) Detection

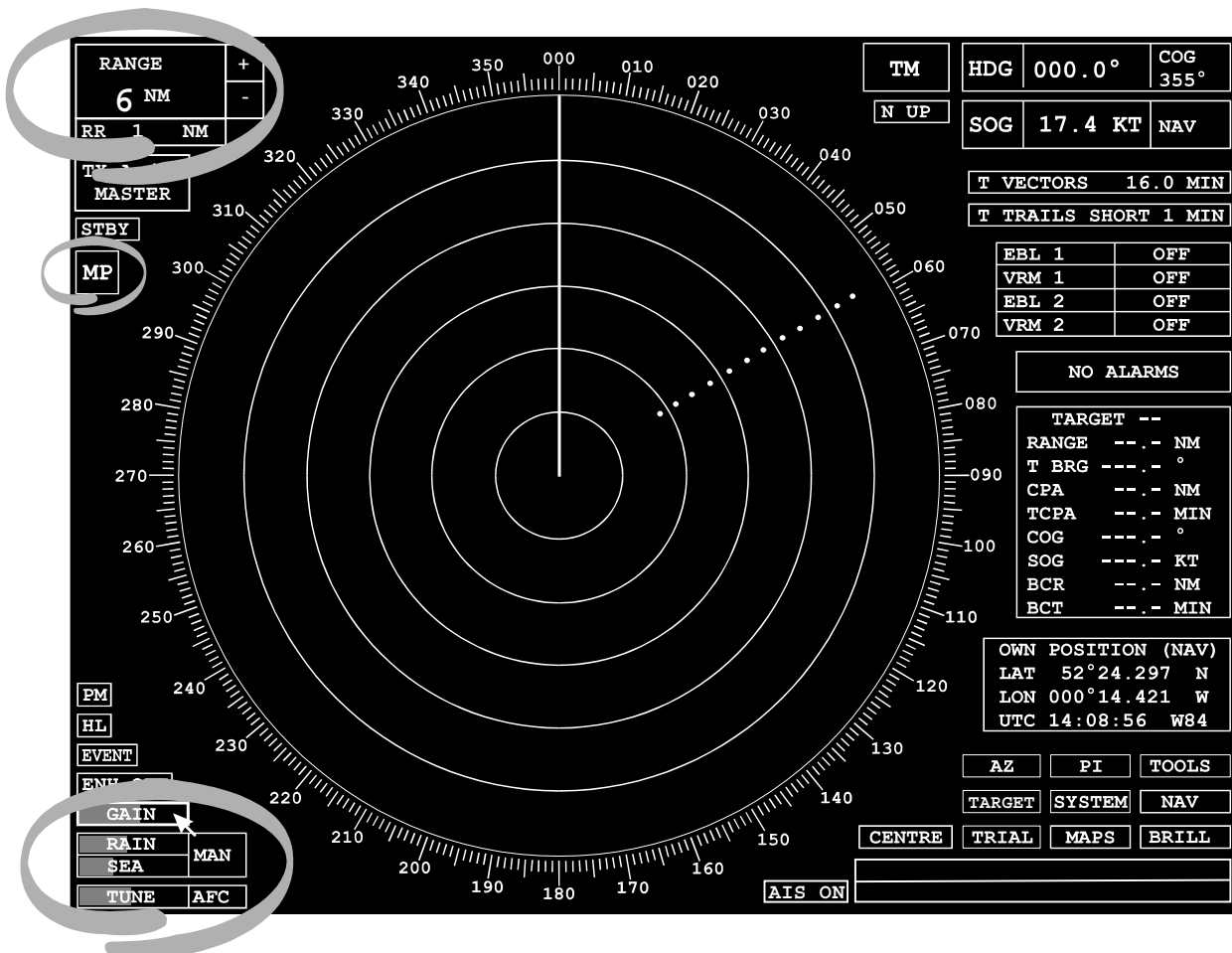

Covered in this chapter:

- Radar response to Search and Rescue Transponder (SART).
- Range scale selection.
- SART range errors.
- Setting the radar controls for best SART detection.

WARNING! A SART will only respond to an X-Band (3cm) radar. It will NOT be seen on an S-Band (10cm) radar.

Introduction

A Search and Rescue Transponder (SART) may be triggered by any X-Band (3cm) radar within a range of approximately 8 nm. Each radar pulse received causes it to transmit a response which is swept repetitively across the complete radar frequency band. When interrogated, it first sweeps rapidly (0.4 μ sec) through the band before beginning a relatively slow sweep (7.5 μ sec) through the band back to the starting frequency. This process is repeated for a total of twelve complete cycles. At some point in the sweep, the SRT frequency will match that of the interrogating radar and be within the pass band of the radar receiver. If the SART is within range, the frequency match during each of the 12 slow sweeps will produce a response on the radar display, thus a line of 12 dots equally spaced by about 0.64 nm will be shown.

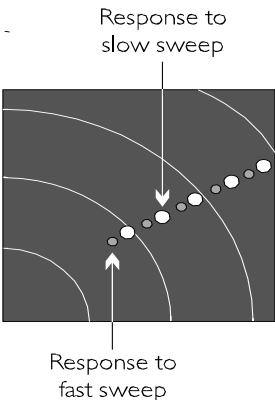
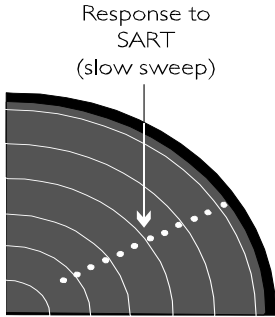

When the range to the SART is reduced to about 1 nm, the radar display may also show the 12 responses generated during the fast sweeps. These additional dot responses, which are also equally spaced by 0.64 nm, will be interspersed with the original line of 12 dots. They will appear slightly weaker and smaller than the original dots.

Radar Range Scale

When looking for a SART, it is preferable to use either the 6 or 12 nm range scale, see Chapter 3, Range Scales and Range Rings. This is because the total displayed length of the SART response of 12 (or 24) dots may extend approximately 9.5nm beyond the position of the SART and it is necessary to see a number of response dots to distinguish the SART from other responses.

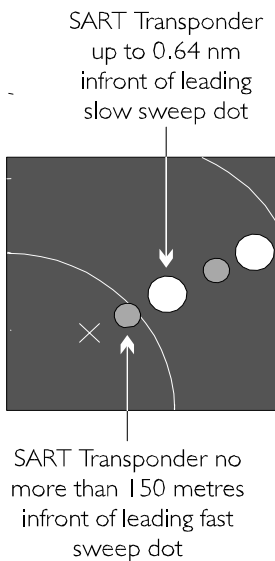

SART Range Errors

When responses from only 12 low frequency sweeps are visible (when the SART is at a range greater than about 1 nm), the position at which the first dot is displayed may be as much as 0.64 nm beyond the true position of the SART. When the range closes so that the fast sweep responses are seen also, the first of these dots will be no more than 150 metres beyond the true position.

Radar Bandwidth

This is normally matched to the radar pulse length and is usually switched with the range scale and the associated pulse length. Narrow bandwidth of 3-5 MHz are used with long pulses on long range scales and wide bandwidths of 10-25 MHz with short pulses on short ranges.

A radar bandwidth of less than 5MHz will attenuate the SART signal slightly, so it is preferable to use a medium bandwidth to ensure optimum detection of the SART, see Chapter 3, Radar Transmission Pulse Length.

Radar Side Lobes

As the SART is approached, side lobes from the radar antenna may show the SART responses as a series of arcs or concentric rings. These can be removed by the use of the anti-clutter sea control although it may be operationally useful to observe the side lobes as they may be easier to detect in clutter conditions and also they will confirm that the SART is near to own ship.

Detuning the Radar



To increase the visibility of the SART in clutter conditions, the radar may be detuned to reduce the clutter without reducing the SART response. The BridgeMaster E Radar is equipped with automatic/manual frequency control and can be detuned manually, see Chapter 3, Transceiver Tuning. Care should be taken in operating the radar in the detuned condition as other wanted navigational and anti-collision information may be removed. The tuning should be returned to normal operation as soon as possible.



Video Gain

For maximum range SART detection the normal gain setting for long range detection should be used, ie with a light background noise speckle visible, see Chapter 3, Video Processing Controls.



Anti-clutter Sea Control

For optimum range SART detection this control should be set to the minimum. Care should be exercised as wanted targets in sea clutter may be obscured. Note also that in clutter conditions the first few dots of the SART response may not be detectable, irrespective of the setting of the anti-clutter sea control. In this case, the position of the SART may be estimated by measuring 9.5 nm from the furthest dot back towards own ship.

The BridgeMaster E Radar has automatic/manual anti-clutter sea control facilities, see Chapter 3, Video Processing Controls. Because of the way in which the automatic sea control functions, the operator is advised to use manual control initially until the SART has been detected. The effect of the auto sea control on the SART response can then be compared with manual control.



Anti-clutter Rain Control

This should be used normally (ie to break up areas of rain) when trying to detect a SART response which, being a series of dots, is not affected by the action of the anti-clutter rain circuitry. Note that Racon responses, which are often in the form of a long flash, will be affected by the use of this control.

The BridgeMaster E Radar has automatic/manual anti-clutter rain control facilities, see Chapter 3, Video Processing Controls. Because of the way in which the automatic control functions, the operator is advised to use manual control initially until the SART has been detected. The effect of the auto rain control on the SART responses can then be compared with manual control.

ANNEX Static Site Radar Installations

B

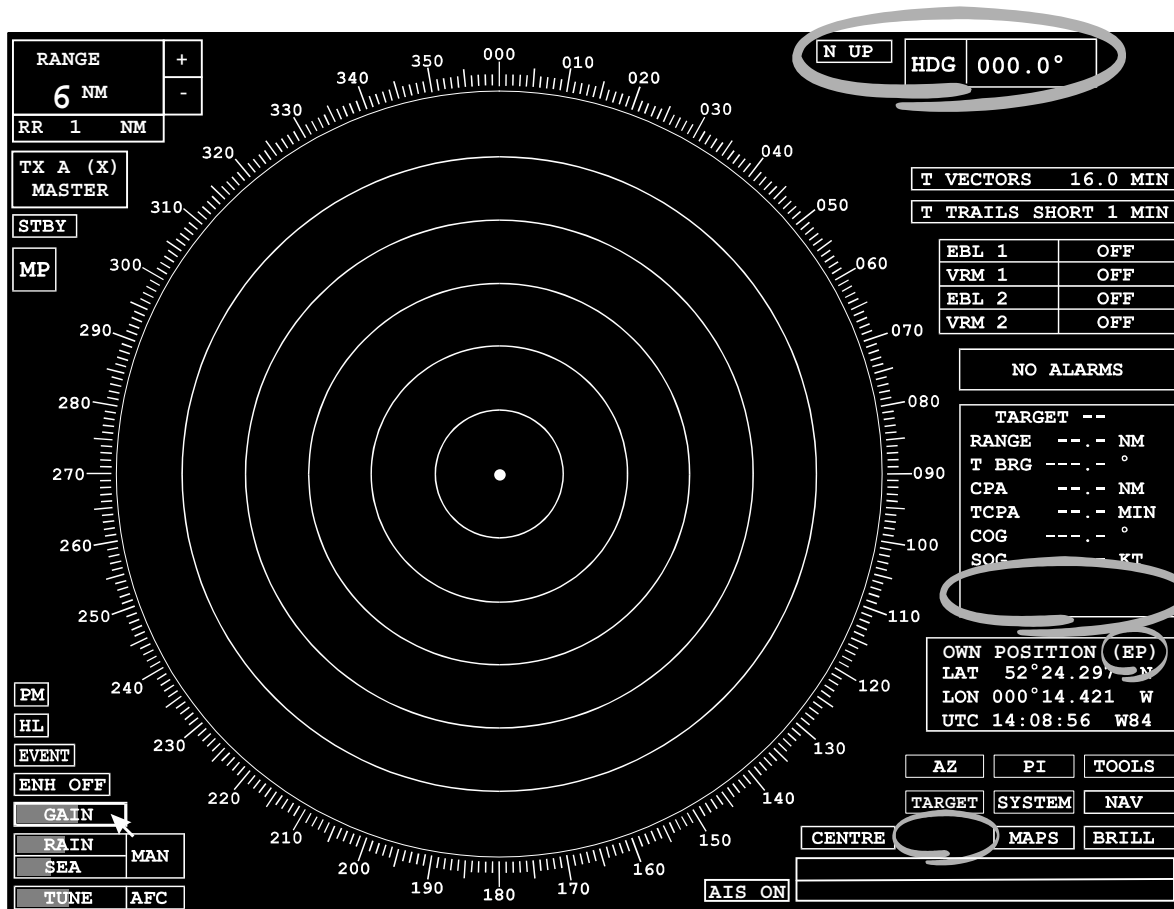

Covered in this chapter:

- Static site radar operation.

Introduction

The BridgeMaster E radar system can be configured as a Static Radar Installation. This 'Static Site' mode-of-operation is selected from the **System Configuration** page during initialisation, see Chapter 4 of Ship's Manual 65800010B. Static site is not available on an EPA(L).

Static Site Radar Operation

When the radar is initialised as a Static Site, the operational functions listed below are NOT AVAILABLE. The chapter references in brackets relate to this User Guide.

- Any type of speed mode (Chapter 4)
- Course-UP reset (Chapter 5)
- Head-Up mode (Chapter 5)
- Relative vectors (Chapter 5)
- Carried/dropped EBL/VRM (Chapter 6)
- Trial Manoeuvre (Chapter 7)
- Bow crossing (Chapter 7)
- Routes (Chapter 9)
- Guard line (Chapter 10)
- Constant radius turn (Chapter 12)
- Own ship's profile (Chapter 12)

Operation of static radar installation is subject to the following changes. The chapter references in brackets relate to this User Guide.

Motion and Presentation Modes

When the radar is configured as a static site, there are no references to the speed of the radar, and the system is always in static motion mode. The motion mode is not presented on the video display. North-Up is the default presentation mode. (Chapters 4 & 5)

Position Modes

When configured as a Static Site, only the 'Estimated Position (EP)' and 'Navigation Sensor (NAV)' position modes are available. In EP mode the position is stored in a non-volatile memory. Hence, the position is immediately available on power-up. The default position mode for static installation is EP. Offsets for the navigation sensor are entered as northings and eastings etc, rather than fore, aft, port and starboard as is the case for standard installations. (Chapter 9)

Heading Mode

A stored heading is available on power-up, so there is no need to enter a heading. However, the heading can be altered if required, and the current heading value is saved in non-volatile memory. The default heading is 000°. The heading line is 'off' by default, but can be displayed momentarily by left clicking and holding on the HL soft key. Note that this control does not suppress all synthetics in the video circle, as is the case for a standard radar. (Chapter 4)

EBL reciprocal bearing

When configured as a Static site, from version 5.00 software, the EBL/ERBL caption box will also display the reciprocal bearing in brackets after the actual bearing. The screen EBL/ERBL will remain unaltered.

Intentionally Blank

NORTHROP GRUMMAN

Sperry Marine

© Northrop Grumman Sperry Marine B.V.