

Operation, Installation and Service Manual

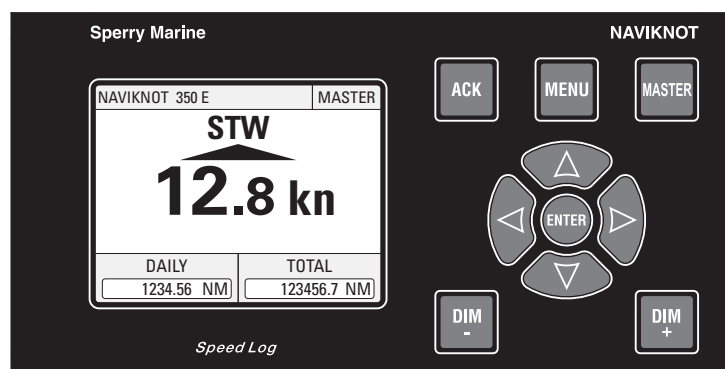

NAVIKNOT 350 E

Electromagnetic Speed Log

056345/C, 22 Jan 2008

© 2008 Northrop Grumman Sperry Marine B.V.

This document and the information herein is the intellectual property of Northrop Grumman Sperry Marine B.V. [NGSM BV] and its associate companies and may not be copied or reproduced without the express permission of NGSM BV.

Specifications were correct at time of press but may be varied in accordance with NGSM BV's policy of continuous product development.

Any technical content should be verified with NGSM BV.

Sperry Marine, with worldwide headquarters in Charlottesville, VA, and major engineering and support offices in Melville, NY, New Malden, England, and Hamburg, Germany, is part of the Northrop Grumman Electronic Systems sector.







Revision Record

Rev.	Date	Remarks
C	22 Jan 2008	minor corrections/additions
B	17 Aug 2007	minor corrections/additions
A	25 Jun 2007	initial version

Safety Instructions

Safety Notice Conventions

The following safety notice conventions are followed throughout this manual:

<div style="background-color: black; color: white; padding: 2px; font-weight: bold; margin-bottom: 5px;">DANGER</div> 	<p>A Danger notice contains an operating or maintenance procedure, practice, condition, statement, etc., which, if not strictly observed, will result in injury or death of personnel.</p>
<div style="border: 1px solid black; padding: 2px; font-weight: bold; margin-bottom: 5px;">WARNING</div> 	<p>A Warning notice contains an operating or maintenance procedure, practice, condition, statement, etc., which, if not strictly observed, could result in injury or death of personnel.</p>
<div style="border: 1px solid black; padding: 2px; font-weight: bold; margin-bottom: 5px;">CAUTION</div> 	<p>A Caution notice contains an operating or maintenance procedure, practice, condition, statement, etc., which, if not strictly observed, could result in damage to, or destruction of equipment.</p>
<p>Note</p> 	<p>A Note contains an essential operating or maintenance procedure, condition or statement, which is considered important enough to be highlighted.</p>
<p>Special safety symbols may be used in this manual to indicate:</p>	
	<p>Risk of electrical shock. Used in conjunction with a Danger or Warning notice.</p>
	<p>Electronic components sensitive to electrostatic discharge. Used in conjunction with a Caution notice.</p>

General Safety Information for the Operator

CAUTION



In the “Manual” and “Extern” modes, the NAVIKNOT 350 E transmits valid output signals and data to the receiving equipment connected.

The function of these modes is to maintain normal operation of speed receivers such as gyrocompasses, RADAR, ARPA etc., in case of failure of the Doppler transducer.

When operating the NAVIKNOT 350 E in the “Manual” mode, make sure that ship’s crew are aware of the fact that speed and distance information from the log is based on manual input.

Operating the NAVIKNOT 350 E in the “Manual” mode may severely affect the proper function of equipment which depends on accurate speed and/or distance data.

When operating the NAVIKNOT 350 E in the “Extern” mode, make sure that ship’s crew are aware of the fact that GPS ground speed data is displayed and transmitted as longitudinal water speed by the NAVIKNOT 350 E.

Operating the NAVIKNOT 350 E in the “Extern” mode may severely affect the proper function of equipment which depends on accurate longitudinal water speed data.

General Safety Information for Service Personnel

Safety information relating to system configuration, maintenance, servicing and troubleshooting is presented in the respective chapters.

Contents

Chapter 1: Introduction

1.1 Design and Main Features	1-1
Data Outputs.....	1-2
1.2 Operating Principle	1-2
1.3 Technical Data	1-3
General.....	1-3
NAVIKNOT Electronics Unit, Type 5003	1-3
NAVIKNOT 350 E Control and Display Unit (CDU)	1-6
Preamplifier E, Type 2863	1-8
EM Log Sensors	1-9

Chapter 2: Operation

2.1 Display and Operating Keys	2-1
Display	2-1
Operating Keys.....	2-1
2.2 External control devices	2-2
2.3 Power-up Sequence	2-2
2.4 Display Indications in Normal Operational Mode	2-3
Speed Display.....	2-3
Distance Counters.....	2-3
Operating Status Indications.....	2-3
Master/Remote status.....	2-3
Manual/External speed input active	2-3
Speed not calibrated.....	2-3
2.5 Requesting Master Control	2-4
2.6 Adjusting the display brightness	2-4
2.7 Optional Functions	2-5
Muting Alarms Remotely.....	2-5
Resetting/Acknowledging a Central Watch Alarm	2-5
External Dimming	2-5
Activating Double-Ended Ferry Mode	2-5
2.8 Operating Menu	2-6
Entering and Quitting the Menu Mode.....	2-6
Navigating the Menu	2-7
Selecting Parameter Settings	2-8
Editing Parameter Values	2-8
2.9 Manual Settings Menu	2-9
Manual Settings – Overview	2-9
Manual Settings – Parameters	2-10
Speed Mode STW	2-10

2.10	User Setup	2-11
	User Setup – Overview	2-11
	User Setup – Parameters	2-13
	Damp. Time Display.....	2-13
	Damp. Time Output	2-13
	Reset Daily Miles.....	2-13
	Total Miles Counter	2-13
	LCD Color.....	2-14
	Scale.....	2-14
	Software Version	2-14

Chapter 3: Alarm System

3.1	Alarm Indication	3-1
	Audible Alarm Indication	3-1
	Single Beep: Invalid Action	3-1
	Continuous Beeping: Pending Alarm	3-1
	Visual Alarm Indication.....	3-1
3.2	Acknowledging Alarms/Muting the Audible Alarm	3-2
	Local Alarm Acknowledge	3-2
	External Alarm Mute	3-2
3.3	Viewing the active alarms	3-3
3.4	Error Messages	3-4

Chapter 4: Scheduled Maintenance

4.1	Maintenance by Shipboard Personnel	4-1
	NAVIKNOT Electronics Unit, CDU and Preamplifier E.....	4-1
	EM-Log Sensor Maintenance	4-1

Chapter 5: Installation

5.1	Mechanical Installation	5-1
	EM-Log Sensor and Preamplifier	5-1
	NAVIKNOT Electronics Unit.....	5-1
	Control and Display Units.....	5-2
	Console Mounting.....	5-2
	Console Frame Version.....	5-2
	Housing with Bracket.....	5-2
	Connector Cable.....	5-2
5.2	Electrical Installation	5-3
	Preamplifier E, Type 2863, AC Power Configuration	5-3
	Wiring Up the System.....	5-3
5.3	Initial System Configuration	5-4
	Configuring the CDU(s).....	5-4
	CDU Setup Access Code.....	5-4
	CDU Service Setup – Overview.....	5-5
	CDU Service Setup – Parameters.....	5-6
	Configuring System Parameters	5-7

Chapter 6: System Configuration

6.1 Service Setup Menu	6-1
Setup Access Code.....	6-1
Service-Setup – Overview	6-2
Service Setup – Parameters	6-6
Analog Output.....	6-6
Pulse Output.....	6-8
RS422 Output 1–3	6-10
RS422 Output 4–6	6-11
NMEA Input 1	6-12
NMEA Input 2	6-13
System Type	6-14
Sensor Sensitivity	6-14
Relay Speed Limit	6-15
Calibration	6-17
Network Setup.....	6-17

Chapter 7: EM Sensor Calibration

7.1 Sensor Sensitivity Setting	7-1
7.2 EM Sensor Calibration	7-2
Editing the Calibration Table Directly	7-3
Zero Point Calibration	7-4
Manual Entry	7-4
Automatic Entry	7-5
Calibration by Trial Runs.....	7-6
Two Way Trial Run	7-7
One Way Trial Run	7-9

Chapter 8: Troubleshooting

8.1 NAVIKNOT Electronics Unit and CDU(s)	8-1
Location of Parts on the Electronics Unit PCB	8-2
Exchangeable Components.....	8-3
Terminal Boards and Connectors	8-3
Diagnostic LEDs.....	8-4
8.2 EM Sensor and Preamplifier	8-5

Chapter 9: Corrective Maintenance

9.1 Exchanging the System Software	9-1
Downloading Software from the Flashboard.....	9-1
Exchanging the Flashboard.....	9-2
Uploading Software via the Service Interface	9-3
9.2 Replacing RS-422 Output Driver ICs	9-3
9.3 Replacing Pulse Output Relays	9-3

Appendix

- A Setup and Configuration Tables**
- B Drawings**

Chapter 1: Introduction

1.1 Design and Main Features

The NAVIKNOT 350 E is a compact solid-state microprocessor controlled system to determine a vessel's longitudinal speed and distance travelled through the water.

The system complies with IMO resolutions A. 824(19) and A.694(17) and with EN/IEC standards 61023, 61162 and 60945.

The NAVIKNOT 350 E has been type-approved by Germanischer Lloyd, in accordance with the Maritime Equipment Directive 2002/75/EC and assigned certificate no. 44675-07 Lux. In accordance with the mutual recognition agreement (MRA), USCG approval no. 165.105 / EC 0801 / 4467507 has been granted.

A basic system consists of the NAVIKNOT 350 E Electronics Unit, a Control and Display Unit (CDU) and an EM (electromagnetic) speed sensor with the Preamplifier E, type 2863. Up to three additional remote CDUs may be connected to the electronics unit.

Figure 1-1:
NAVIKNOT 350 E
system

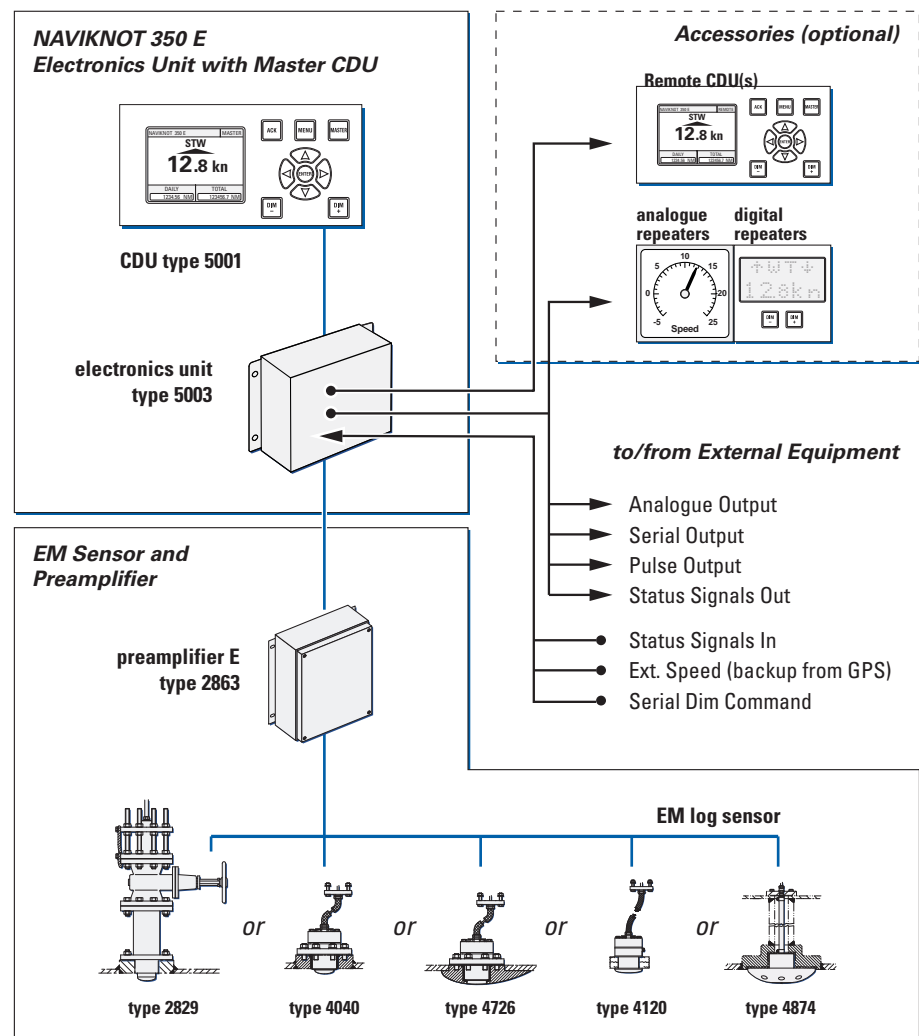

Data Outputs

The Electronics Unit receives the raw speed data from the preamplifier E and applies any necessary corrections according to a stored calibration table. The unit then transmits the calibrated water speed data to receiving equipment and to the connected CDUs. It also calculates the distance travelled and maintains the total and daily mile counters.

Serial speed and distance data is provided in the NMEA 0183 / IEC 61162 format at six RS-422 outputs. These are divided into two groups of three outputs each, which may be configured independently to suit the receiving equipment.

Analogue speed signals are provided at one voltage and one current output. The mapping of actual speeds to corresponding output values is configured for each output independently.

The distance travelled is also provided as a pulse signal at six contact closure outputs. These are divided into three groups of three, two and one output respectively, which may be configured independently to provide 10, 100, 200, 400 or 20000 pulses per nautical mile.

1.2 Operating Principle

The NAVIKNOT 350 E system utilizes the electromagnetic principle to determine the vessel's longitudinal speed through the water. The EM sensor generates a magnetic field around itself when an AC current is applied to its excitation coil. The ship's motion through the water gives rise to an electrical field (E) perpendicular to the magnetic field (B) and the ship's motion (V). The resulting signal is picked up by the sensor electrodes and passed on to the preamplifier. The preamplifier converts the sensed ("raw") speed to a digital format (NAVIKNOT protocol) and transmits it to the electronics unit.

Figure 1-2:
EM-Log
operating principle

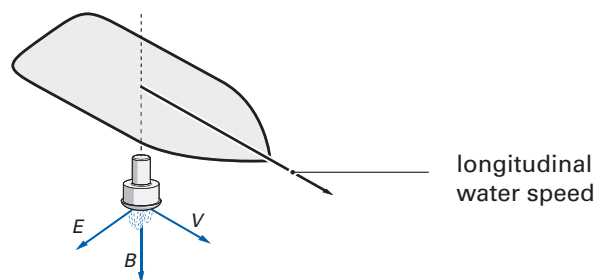

1.3 Technical Data

General

Speed/Distance Ranges and Accuracies

measuring range	
sensor FNF I, type 4040	-35 to +35 kn ¹
type 4726 with hydrofairing	-20 to +60 kn
sensor FNF II	-35 to +35 kn
sensor FNF III	-35 to +35 kn
sensor NF	-30 to +30 kn
accuracy relative to water flow at sensor head	0.1 kn or better

1 Negative values apply only if sensor location and vessel's hull shape permit the sensing of speeds astern.

NAVIKNOT Electronics Unit, Type 5003

Environmental Requirements

ambient temperature, operation	-15 °C – +55 °C
ambient temperature, storage	-25 °C – +70 °C
protection grade	IP 23 to DIN EN 60529
environmental conditions / EMC	in accordance with IEC 60945

Power Supply

supply voltage	24 VDC (18-36 V)
max. ripple content	±4 V _{pp} ; extreme values may not exceed 36 V or fall below 18 V
power consumption	5 W max.

Magnetic Clearance

to standard magnetic compass	0.5 m
to steering magnetic compass	0.4 m
reduced, to standard magnetic compass	0.3 m
reduced, to steering magnetic compass	0.3 m

Dimensions and Weight

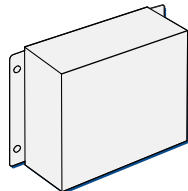
width	340 mm	
height	250 mm	
depth	100 mm	
weight	4.0 kg	

Data Inputs

EM sensor speed data	NAVIKNOT serial protocol
Control and Display Unit data	NMEA 0183 / IEC 61162 (proprietary sentences)
ext. speed data (backup from GPS)	NMEA 0183 / IEC 61162
serial dimming command	NMEA 0183 / IEC 61162

Signal and Status Inputs

double ended ferry mode	connection to P.Gnd via ext. contact, latching
ext. alarm acknowledge status (mute)	connection to P.Gnd via ext. contact, momentary, normally open
ext. dim+ ext. dim-	connection to P.Gnd via ext. contact, momentary, normally open

Data Outputs

serial data RS-422 outputs, group 1 (3x)	NMEA 0183 / IEC 61162; <i>all or selected subset of:</i> longitudinal water speed distance travelled log status (proprietary sentence)
serial data RS-422 outputs, group 2 (3x)	NMEA 0183 / IEC 61162; <i>all or selected subset of:</i> longitudinal water speed distance travelled log status (proprietary sentence)

Signal and Status Outputs

analogue speed output, voltage	max. range -9.999 – 9.999 VDC; speed mapped to output voltage through definition of min. and max. speed/voltage pairs
analogue speed output, current	max. range 0 – 20 mA; speed mapped to output current through definition of min. and max. speed/current pairs
pulse outputs, group 1 (outputs 1,2 and 3)	10, 100, 200, 400 or 20000 p/nm
pulse outputs, group 2 (outputs 4 and 5)	10, 100, 200, 400 or 20000 p/nm
pulse output 6	10, 100, 200, 400 or 20000 p/nm or ext. alarm mute
power failure/general alarm speed log failure alarm speed limit threshold alarm watch alarm acknowledge	potential-free relay contacts, each rated 30 VDC/1.0 A, 100 VDC/0.3 A, 125 VAC/0.5 A;

NAVIKNOT 350 E Control and Display Unit (CDU)

Environmental Requirements

ambient temperature, operation	-15°C – +55°C
ambient temperature, storage	-25°C – +70°C
protection grade	<i>Stock No. 73506</i> : frontside IP 65 to DIN EN 60529, if installed with seal in console panel; IP 23 if installed in console frame <i>Stock No. 73507 (in housing with bracket)</i> : IP 65 to DIN EN 60529
environmental conditions / EMC	in accordance with IEC 60945

Power supply

supply voltage	24 VDC (18-36 V)
max. ripple content	±4 V _{pp} ; extreme values may not exceed 36 V or fall below 18 V
power consumption	4 W max.

Magnetic Clearance

to standard magnetic compass	0.80 m
to steering magnetic compass	0.50 m
reduced, to standard magnetic compass	0.50 m
reduced, to steering magnetic compass	0.30 m

Dimensions and Weight

Stock No. 73506 (for console mounting)

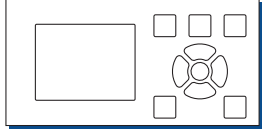
width	192 mm	
height	96 mm	
depth	44 mm; approx. 100 mm backward clearance from mounting surface required for connector cable	
weight	2.4 kg	

Stock No. 79488 (Stock No. 73506 factory-assembled in console frame)

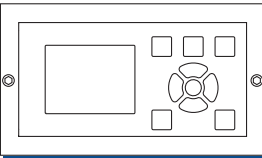
frame width	223 mm	
frame height	127 mm	

Stock No. 73507 (in housing with bracket)

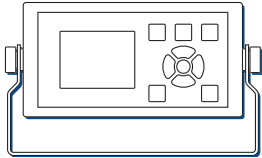
width	256 mm	
max. height (unit in vertical position)	155 mm	
max. depth (unit in horizontal position)	116 mm	
weight	3.2 kg	

Preamplifier E, Type 2863

Environmental Requirements

ambient temperature, operation	-15 to +55 °C
ambient temperature, storage	-25 to +70 °C
protection grade	IP 56 to DIN EN 60529
environmental conditions / EMC	in accordance with IEC 60945

Power Supply

supply voltage	230 VAC or 115 VAC, 50-60 Hz
power consumption	24 W

Magnetic Clearance

to standard magnetic compass	0.3 m
to steering magnetic compass	0.3 m

Dimensions and Weight

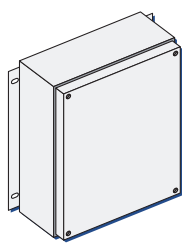
width	239 mm	
height	285 mm	
depth	83 mm	
weight	3.0 kg	

EM Log Sensors

Common Operational Data

excitation voltage	24 VAC
excitation current	1 A
nominal output voltage	180 μ V/kn

Sensor NF, Type 2829

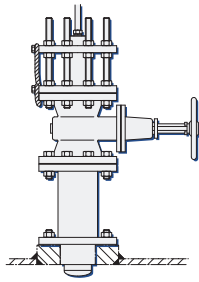
sensor for steel or aluminium vessels, single or double bottom	
installation method	from inside vessel, through hull fittings
pressure resistance	> 4 bar (4000 hectopascal)
cable length	30 m
dimensions	see drawing 2829-0112-01
weight	sensor approx. 20 kg hull fittings approx. 50 kg

Sensor FNF I, Types 4040 and 4726

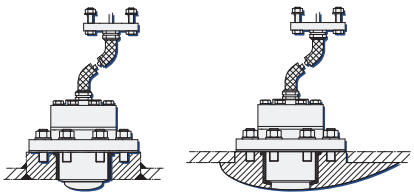
sensor for steel or aluminium vessels, single or double bottom	
installation method	from inside vessel, in drydock
pressure resistance	> 2 bar (2000 hectopascal)
cable length	20 m
dimensions	see drawing 4040-0112-01 or 4726-0112-01 respectively
weight	17.0 kg

Sensor FNF II, Type 4120

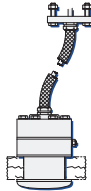
sensor for wooden or glass-fibre vessels	
installation method	from inside vessel, in drydock
pressure resistance	> 2 bar (2000 hectopascal)
cable length	20 m
dimensions	see drawing 4120-0120-01
weight	15.0 kg

Sensor FNF III, Type 4874

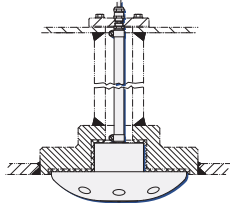
sensor for steel or aluminium vessels, single or double bottom	
installation method	from outside vessel; sensor can be exchanged without drydocking by a diver
pressure resistance	> 4 bar (4000 hectopascal)
cable length	30 m
dimensions	see drawing 4874-0112-01
weight	22.0 kg

Chapter 2: Operation

2.1 Display and Operating Keys

Figure 2-1:
NAVIKNOT 350 E
operating unit

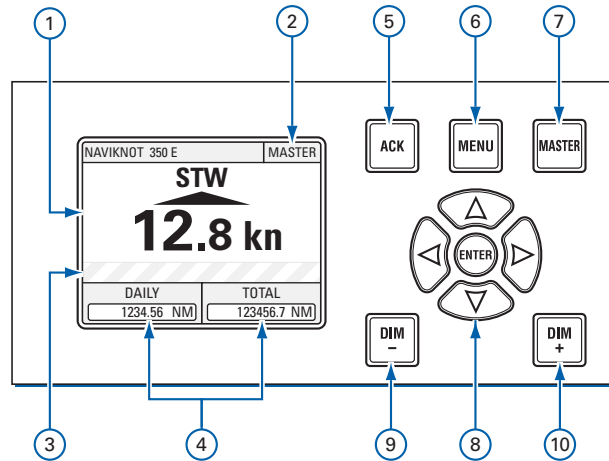

Display

- ① **Speed Display:** Shows the actual speed through the water along the vessel's longitudinal axis (fore-and-aft line).
Arrow pointing up, above value: speed is positive (ahead).
Arrow pointing down, below value: speed is negative (astern).
- ② **Mode Indicator:** indicates the operating mode (Master or Repeater).
- ③ **Alarm Display Area:** In case of pending alarms, the alarm code(s) and error messages are shown in this area.
- ④ **Mile Counters:** Show the distance travelled since last reset (daily miles) and total cumulative distance travelled (total distance).

Operating Keys

- ⑤ **ACK** key: Acknowledge pending alarms; mute alarm buzzer.
- ⑥ **MENU** key: Call up or quit the menu mode.
- ⑦ **MASTER** key: Requests Master operating mode for this unit.
- ⑧ **Navigation Keypad:**
UP, DOWN, LEFT, RIGHT keys navigate through the operating menu;
ENTER confirms and stores settings made in the menu mode.
In case active alarms are present, the left and right arrow keys scroll through the list of alarm messages.
- ⑨⑩ **DIM- / DIM+**: Adjust the display brightness.

2.2 External control devices

Depending on the installation, external devices may be present to remotely control certain functions of the NAVIKNOT 350 E:

- The audible alarm at the NAVIKNOT 350 E may be muted from a remote device, e.g. a central alarm panel.
- External pushbuttons may be used to adjust the display brightness.
- If connected to a central dimming facility, the NAVIKNOT 350 E may receive dimming commands via a serial data connection.
- An external selector switch may be used to activate or de-activate the double-ended ferry mode. In this mode, the NAVIKNOT 350 E displays and transmits all speeds with the sign reversed.

2.3 Power-up Sequence

The separate components of the NAVIKNOT system are not equipped with power switches. All devices power up simultaneously, as soon as supply power is applied to the system.

Upon power up, the startup routine is executed:

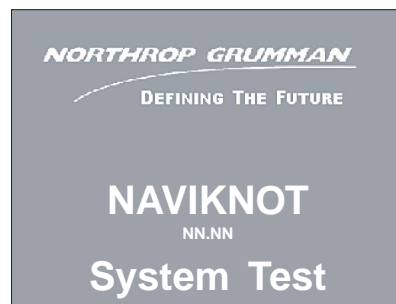

The startup screen is shown and a system test sequence is executed.

A status line at the bottom of the screen indicates the progress and results of the following tests:

RAM test
I/O test
Checksum test
Setup Data test

NAVIKNOT 350 E		MASTER
STW  12.8 kn		
DAILY	TOTAL	
1234.56 NM	123456.7 NM	

After the system test, the indication "waiting for main unit" may be briefly shown at the CDU, while the electronics unit initializes itself.

As soon as the system is fully operational, the actual speed and the daily and total mile counters are displayed.

Note



Should the NAVIKNOT electronics fail to establish communication with the CDU(s) after power-up, the indication "waiting for main unit" will be shown permanently at all connected CDUs. An audible alarm is sounded which must be locally acknowledged at each CDU.

The NAVIKNOT system will not operate properly until the cause of failure is eliminated and should be powered down until it can be serviced.

2.4 Display Indications in Normal Operational Mode

Speed Display



In the normal operational mode, the NAVIKNOT 350 E CDU permanently display the actual speed through the water (STW).

An up-arrow symbol above the speed value indicates positive speeds (ahead), a down-arrow symbol below the value indicates negative speeds (astern).

The value is displayed without sign.

Distance Counters

DAILY	TOTAL
1234.56 NM	123456.7 NM

Also permanently displayed are the distance counters (daily and total mile counters).

The counters display the distance made good through the water.

The count is incremented at positive speeds only; counting is halted during zero or negative speeds.

Operating Status Indications

NAVIKNOT 350 E	MASTER
NAVIKNOT 350 E	REMOTE

Master/Remote status

The indication "MASTER" is shown in the top right corner of the CDU which currently the master unit. Other CDUs, if present, will show the indication "REMOTE"

MAN	STW
EXTERN	STW

Manual/External speed input active

When the manual or external input mode has been activated in the manual settings menu, the indication "MAN" or "EXTERN" respectively is shown in the top left corner of the speed display.

STW	UNCAL
-----	-------

Speed not calibrated

When the sensor calibration table is empty or calibration has been switched off, the indication "UNCAL" is shown in the top right corner of the speed display.

2.5 Requesting Master Control

In case more than one CDU is installed, only one of these can be assigned master control; all other CDUs will operate as remote units.

Only from the master, the operator can access the operating and service menus, acknowledge alarms and scroll through the alarm list.

Remote CDUs permanently display speed and distance. The only keys functional at a remote CDU are the **DIM-/DIM+** keys to adjust the brightness level and the **MASTER** key, which requests master control to be transferred to this CDU.

To request master control at a remote CDU:

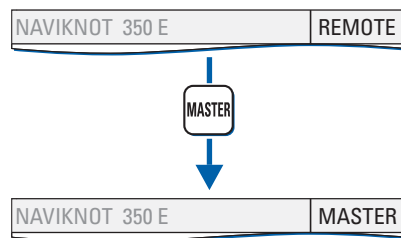

Press the **MASTER** key. Master control is transferred and the mode indication changes from "REMOTE" to "MASTER".

Note



Master control can only be requested from a CDU which is currently operating as remote unit. The current master cannot actively transfer control to a remote CDU. Any remote CDU may request master control at any time, i.e. control requests cannot be refused by the current master.

2.6 Adjusting the display brightness

The brightness of the display and keypad illumination is adjusted via the **DIM+/DIM-** keys:

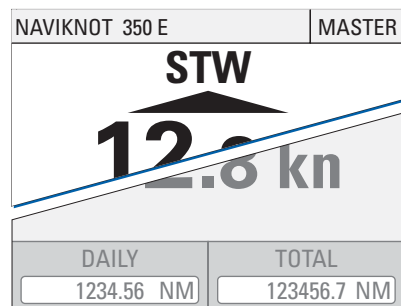

Press the **DIM+** key to increase the illumination brightness. Press the **DIM-** key to reduce the illumination brightness.

Note



The display brightness can only be adjusted in normal operational mode. The brightness setting is not retained between power-ups. The NAVIKNOT 350 E always powers up at the second brightest level.

2.7 Optional Functions

The following functions may be available if the system is equipped with the respective external controls and configured accordingly.

Muting Alarms Remotely

On alarm, actuate the mute control at a remote device (e.g. a central alarm panel). The audible alarm is muted.

Note



A remotely muted alarm remains in the pending (unacknowledged) state. The alarm is indicated as pending in the alarm display area until the alarm is acknowledged at the NAVIKNOT 350 E or the cause of the alarm is eliminated.

Resetting/Acknowledging a Central Watch Alarm

If connected to a central watch alarm facility ('dead man alarm'), the NAVIKNOT 350 E automatically resets the watch alarm timer whenever a key is pressed on the unit.

Should a watch alarm be given, press any key at the NAVIKNOT 350 E to acknowledge the alarm and reset the watch alarm timer.

External Dimming

If external **DIM+/DIM-** pushbuttons are installed, these operate in parallel with the builtin **DIM+/DIM-** keys.

For future applications, the NAVIKNOT 350 E also possesses an input for serial data dimming commands from a central dimming facility.

Activating Double-Ended Ferry Mode

In certain installations, a switch may be installed to activate or de-activate the double-ended ferry mode. If this mode is active, If this mode is active, all speeds are displayed and transmitted with their sign reversed.

Note



In most installations where the double-ended ferry mode is used, it will be automatically activated via a general take-over system which transfers control between the forward and aft steering positions.

2.8 Operating Menu

The manual settings, user and service setup sub-menus are accessed through a multilevel operating menu.

Entering and Quitting the Menu Mode

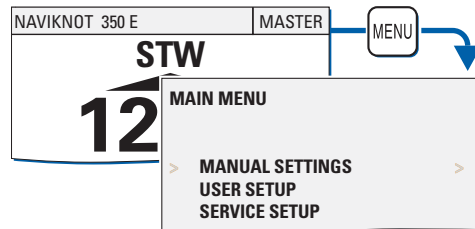

From the normal operational mode, press **MENU** to enter the menu mode.

The Main Menu screen is displayed. The keys of the navigation keypad may now be used to navigate the menu, to select parameter settings and to edit parameter values.

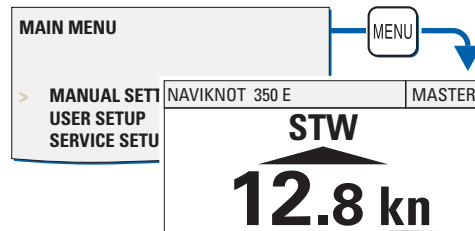

From the main menu screen, press **MENU** to return to the normal operational mode.

The Main Menu screen is closed and the normal operational display reappears.

Note



In the menu mode, the **MASTER** and the **DIM-/DIM+** keys are disabled. Should an alarm condition occur while the menu mode is active, the audible alarm will sound, but the operator must return to normal operational mode to view the alarm message and acknowledge the alarm.

Navigating the Menu

In the menu mode, the operator may navigate through the menu using the **Right**, **Left**, **Up** and **Down** arrow keys.

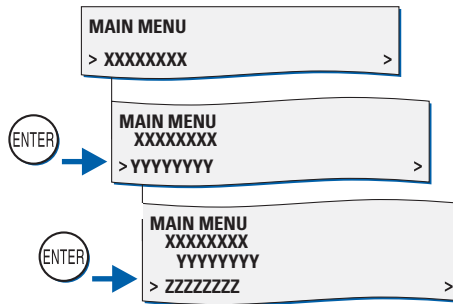

Arrow symbols (>) to the right of the window indicate that a sub-menu exists for the respective option.

Press **ENTER** to enter a sub-menu.

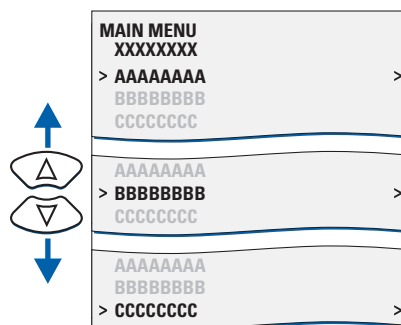

The arrow symbol (>) at the left of the window indicates the cursor position on the current menu level.

With the **Up/Down** arrow keys, move to the cursor to the required sub-menu position.

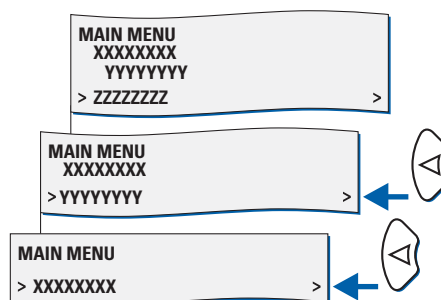

Press the **Left** arrow key to return to the next higher menu level.

Alternatively, **MENU** may be pressed to jump as high up as possible from the current level. In most cases, this will quit the menu immediately and return to normal operational mode.

Selecting Parameter Settings

In a number of sub-menus, the operator is expected to select parameter settings from a list of available options.

The available options and the current selection are indicated by different symbols:

Radio buttons: Allow to select exactly one of the available options.

- ⦿ : selected
- : deselected

Checkboxes: Allow to select or activate none, one or more of the available options.

- ☒ : selected
- ☐ : deselected

To select parameter settings in a sub-menu:

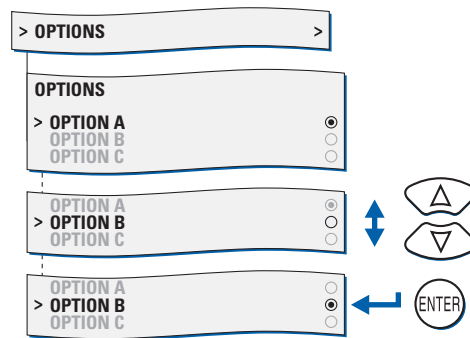

With the **Up/Down** arrow keys, move to the required option.

Press **ENTER** to confirm the selection and leave the option sub-menu.

MENU leaves the option sub-menu without changes.

Editing Parameter Values

In a number of sub-menus, parameters are set by editing a numerical value or an alphanumerical string.

To edit a parameter value in the respective sub-menu:

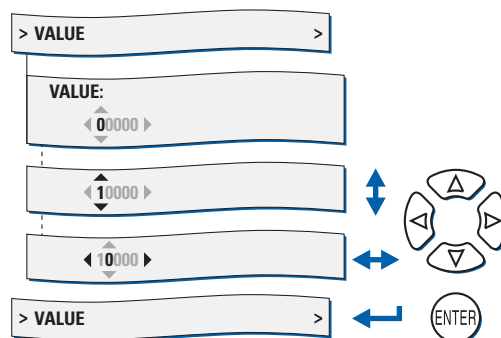

With the **Up/Down** arrow keys, edit the character at the current cursor position.

With the **Right/Left** arrow keys, move the cursor forward/back to edit the next/previous character.

Press **ENTER** to confirm the new value and leave the option sub-menu.

MENU leaves the option sub-menu without changes.

2.9 Manual Settings Menu

The Manual Settings menu provides access to settings which the operator may need to alter more or less frequently during normal operation.

Manual Settings – Overview

Figure 2-2:
Manual Settings

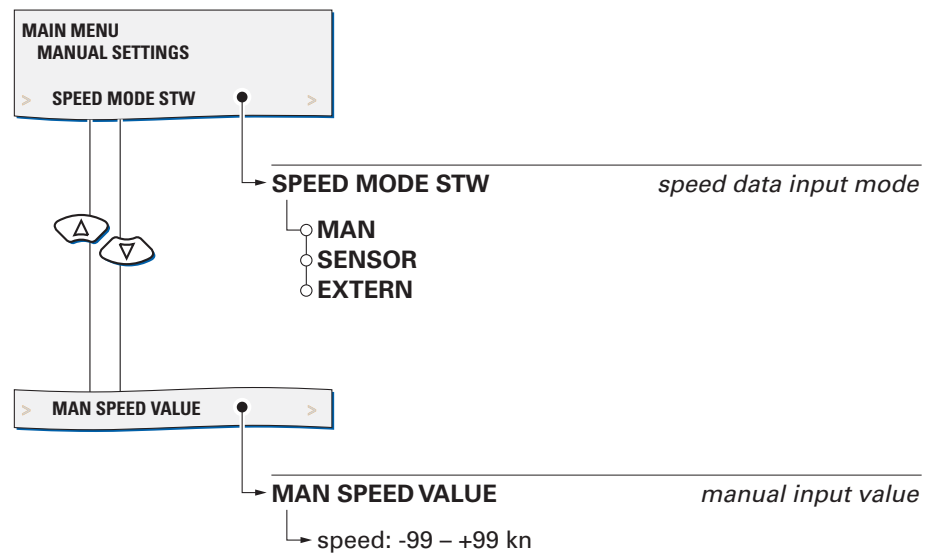

Manual Settings – Parameters

Speed Mode STW

Selects the speed input mode.

Settings: **MAN**

The actual speed value is entered manually.
This setting may be chosen only temporarily, to generate speed output data in case of sensor failure or for testing.

SENSOR

Speed data is read from the speed sensor input.
This setting must be active at all times during normal operation of the system.

EXTERN

Speed data is read from the NMEA \$--VTG sentence at one of the NMEA inputs 1 or 2.
This setting allows to use speed data from a GPS instead of manual input. Note that, while the \$--VTG sentence contains ground speed, the NAVIKNOT 350 E displays and transmits the data as water speed. The external input may therefore be chosen only temporarily, to generate output data in case of transducer failure or for testing.

Man. Speed Value

Sets the input value in the manual input mode.

Value: **-99.9 – 99.9 kn**

2.10 User Setup

The User Setup menu provides access to settings which the operator may need to alter only occasionally.

User Setup – Overview

Figure 2-3:
User Setup

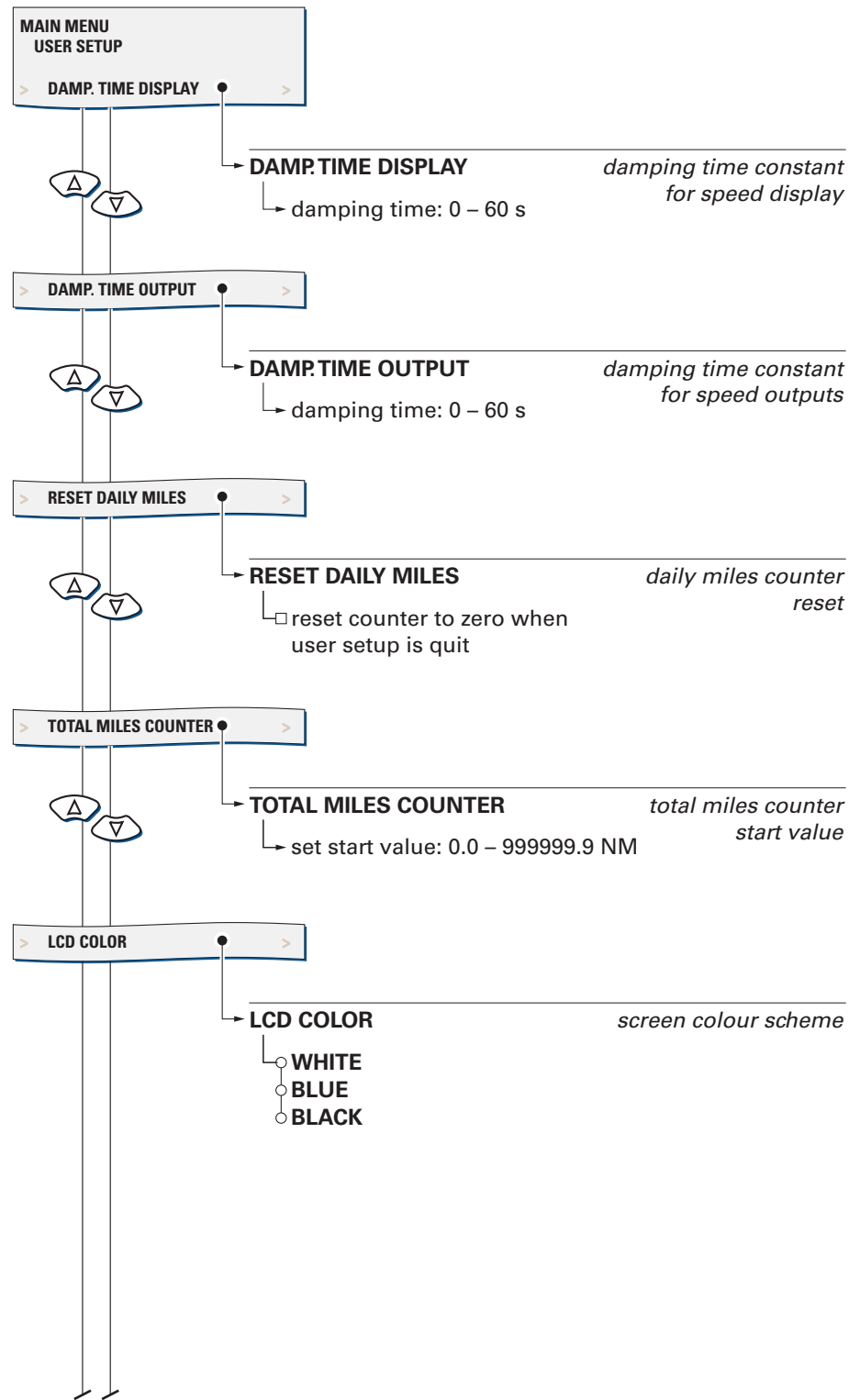

contd. on next page

Figure 2-4:
User Setup
(contd.)

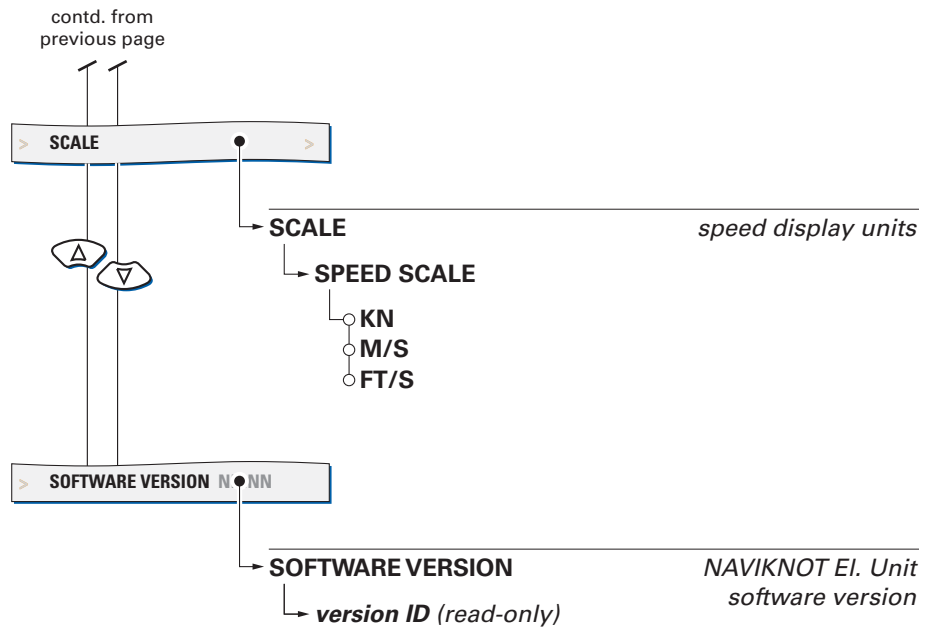

User Setup – Parameters

Damp. Time Display

Sets the damping time constant for the speed display.

The higher the time constant, the stronger sudden peaks of the actual speed display will be damped.

Value: **0 – 60 s**

Damp. Time Output

Sets the damping time constant for the speed outputs.

The higher the time constant, the stronger sudden peaks of the actual speed output will be damped. The output damping time constant is effective for both the analogue as well as the serial data outputs.

Value: **0 – 60 s**

Reset Daily Miles

Sets the reset flag for the daily miles counter.

If the reset flag is set, the daily miles counter is reset to zero as soon as the User Setup is quit.

Settings: **ON** (option checked)
Reset daily miles counter when User Setup is quit

OFF (option unchecked)
Leave daily miles counter untouched

Total Miles Counter

Sets the total miles counter to a desired start value.

Value: **0.0 – 999999.9 NM**

Note

The total miles counter may be set to any desired start value. The daily mile count may thus be larger than the total mile count if the daily miles counter is not reset after altering the total mile counter.

LCD Color

Selects the screen colour scheme for the normal operational display.

Settings: **WHITE**
Speed display and mile counters use black lettering on a white background.

BLUE
Speed display and mile counters use white lettering on a blue background.

BLACK
Speed display and mile counters use white lettering on a black background.

Scale

Selects the unit of measure for the speed display.

The respective setting acts on the actual speed display at the CDU only and has no further effect on the output data, mile counters etc.

Settings: **KN**
Speed is displayed in knots.

M/S
Speed is displayed in metres per second.

FT/S
Speed is displayed in feet per second.

Software Version

Displays the software version of the NAVIKNOT Electronics Unit.

Settings: **none**
The version ID is read-only.

Chapter 3: Alarm System

3.1 Alarm Indication

Audible Alarm Indication

Single Beep: Invalid Action



A single short beep indicates that the operator attempted to carry out an invalid action.

This is the case e.g. if the operator attempts to enter the menu from a remote unit.

Continuous Beeping: Pending Alarm



Continuous on-off beeping indicates that a pending (unacknowledged) alarm is present.

Simultaneously, a corresponding alarm message is shown in the alarm window.

Visual Alarm Indication

If an alarm is active, a messages is shown in the alarm display area (above the mile counters) which specifies the alarm at hand.

Active alarms have one of two possible states:



Pending (unacknowledged):

The cause of the alarm is present and the operator has not yet acknowledged the alarm.

The alarm message is shown on a red flashing background.



Acknowledged:

The operator has acknowledged the alarm but the cause of the alarm is still present.

The alarm message is shown on a solid red background.

3.2 Acknowledging Alarms/Muting the Audible Alarm

Local Alarm Acknowledge

To acknowledge a pending alarm at the NAVIKNOT 350 E CDU:

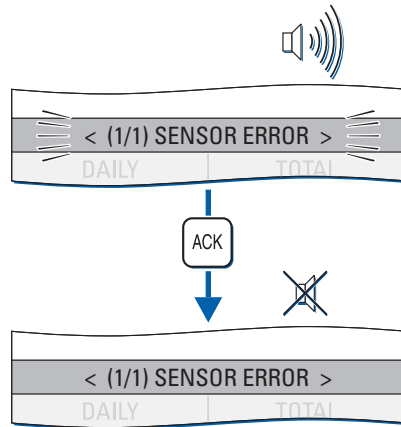

Press **ACK**.

The audible alarm indication is muted.

If the system is connected to a central alarm facility and configured accordingly, the audible alarm indication at the central alarm facility will also be muted.

Note



When an alarm has been acknowledged, the ext. alarm status output remains active until the cause of the alarm is eliminated.
 When the cause of an alarm is eliminated, the alarm is acknowledged automatically and the alarm status is cleared.
 The NAVIKNOT 350 E does not keep a history of past (inactive) alarms.

External Alarm Mute

To mute the audible alarm externally (e.g. from a central alarm panel):

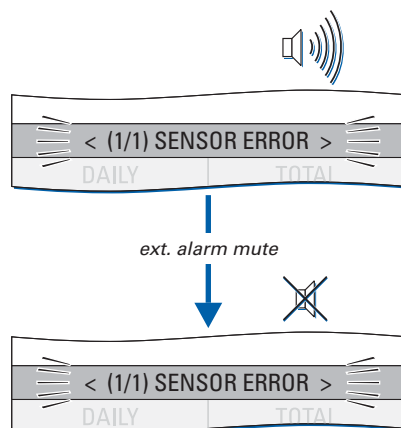

Actuate the external mute facility.

The audible alarm indication is muted.

The alarm state and visible indication are not affected, i.e. the alarm remains in the pending state until it is locally acknowledged at the NAVIKNOT 350 E CDU.

3.3 Viewing the active alarms

The total number of alarms and the index number of the currently displayed alarm are shown in front of the alarm message.

If more than one alarm is active, use the Left or Right arrow key to scroll through the list of alarm messages:

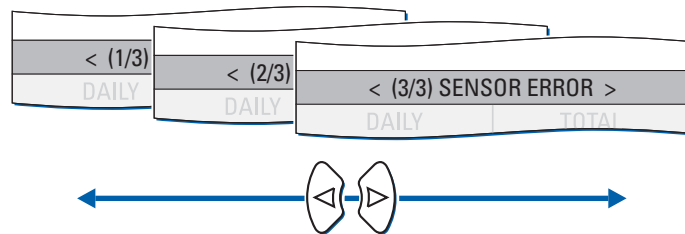

Note

As long as any pending (unacknowledged) alarms are present, these will automatically be redisplayed when other messages have been viewed, until all alarms have been acknowledged by the operator.

3.4 Error Messages

Table 3-1:
error messages

message text	cause	corrective action
WAITING FOR MAIN UNIT (shown on startup screen)	Communcation between electronics unit and CDU(s) could not be established	Check operation of the electronics unit; Check cabling between CDU and electronics unit. If error persists, power down the system and call service.
SENSOR1 ERROR	No valid data received from the preamplifier E	Check that the preamplifier is operating; check cabling between preamplifier and electronics unit; check cabling between sensor and preamplifier, check sensor for proper operation.
EXT DIM TIMEOUT	No valid commands received at serial dim input.	Check connection between dimming device and electronics unit.
EU TIMEOUT	Communication lost between electronics unit to CDU	Check basic operation of the electronics unit (valid output generated at serial data / analogue outputs); Check cabling between CDU and electronics unit.

Note



In case of an "EU timeout" error, dashes will appear in the speed and distance displays. The timeout error will be shown as the only fault present, because the CDU receives no error messages from the electronics unit when the communication is lost.

Chapter 4: Scheduled Maintenance

4.1 Maintenance by Shipboard Personnel

NAVIKNOT Electronics Unit, CDU and Preamplifier E

The electronic components of the NAVIKNOT 350 E system are solid-state devices and contain no consumable parts. Therefore, no set maintenance schedule is required.

The CDU front plate should be kept clean and a regular visual inspection of the system's cables and connectors should be carried out to detect any signs of damage or deterioration.

CAUTION



The CDU front plate is made of clear polycarbonate.

Do not clean the front plate with organic solvents, acetone or any other substance which could damage or discolour plastic.

Use only water and soap or a mild detergent to clean the front plate.

EM-Log Sensor Maintenance

Depending on the type of EM-sensor installed, certain maintenance procedures are to be carried out at regular intervals, such as cleaning of the sensor head and lubrication/overhaul of the sea valve, if applicable.

The recommended maintenance schedule and procedures are described in the installation, maintenance and service instructions for the respective sensor. The following documents apply:

- Sensor NF: document no. 002829-0125-001;
- Sensor FNF I: document no. 004040-0125-001;
- Sensor FNF II: document no. 004120-0125-001;
- Sensor FNF III: document no. 004874-0125-001.

Chapter 5: Installation

5.1 Mechanical Installation

EM-Log Sensor and Preamplifier

Details of the installation of the EM-log sensor and the preamplifier E are contained in the installation, maintenance and service instructions and the dimension/installation drawing for the respective sensor and preamplifier E. The following technical documents apply:

- Sensor NF: document no. 002829-0125-001;
- Sensor FNF I: document no. 004040-0125-001;
- Sensor FNF II: document no. 004120-0125-001;
- Sensor FNF III: document no. 004874-0125-001.

In general, field service will attend a vessel after the sensor has been installed mechanically by the shipyard or, in case of the sensor NF, after the hull fittings have been installed. In most cases, the vessel will be afloat at this point in time.

The preamplifier may be installed at the same time as the sensor or later, together with the other electronic components of the NAVIKNOT 350 E system.

NAVIKNOT Electronics Unit

The NAVIKNOT electronics unit is to be installed at a protected location. In most cases, it will be mounted in the vicinity of the master CDU.

The electronics unit is to be attached to a level surface with four M6 screws (or nuts and bolts). For the dimensions of the housing, refer to drawing 5003-0112-01. The electronics unit may be installed vertically, horizontally or inclined.

Control and Display Units

Console Mounting

To mount a NAVIKNOT CDU directly in a console panel (without console frame), a panel cutout is required as shown in drawing 5001-0112-02 (see Appendix). Suitable fasteners for console mounting are provided in the installation kit 22724, included with the CDU.

A backward clearance of approx. 100 mm from the mounting surface is required to protect the connector cable from being bent too strongly at the cable gland.

Console Frame Version

When ordered factory-assembled in a console frame, the NAVIKNOT CDU is already fastened to the frame. The required cutout for a standard 2x1 frame is shown in drawing 0012-0112-02 (see Appendix).

If a custom frame is delivered, installation-specific dimensional drawings for the frame and cutout will be provided with the equipment.

A backward clearance of approx. 90 mm from the frame top surface is required to protect the connector cable from being bent too strongly at the cable gland.

Housing with Bracket

The NAVIKNOT CDU in housing with bracket is shown in dimensional drawing 5001-0112-02 (see Appendix). The mounting bracket carries four holes of 5.3 mm dia. for fixing the bracket to any plane surface, such as a console panel, wall or ceiling. The required fasteners are to be provided by the shipyard or installer.

Connector Cable

The NAVIKNOT CDU connector cable terminates into a 6-wire pigtail for direct connection to the terminals at the Electronics Unit or to a separate terminal block. If required, a terminal block is to be provided by the shipyard or installer.

The installer must make sure that the end of the cable sheath is firmly secured to the vessel structure with tie-wraps or other suitable means, so that the individual wires are free from tension at the terminals.

5.2 Electrical Installation

Preamplifier E, Type 2863, AC Power Configuration

The preamplifier is delivered prewired for connection to 230VAC. If the amplifier is required to operate on 115 VAC, it must be reconfigured accordingly.

Details of the AC power configuration are described in the applicable installation, maintenance and service instructions for the sensor.

Wiring Up the System

DANGER



When the AC supply power is switched on, live voltages are present at certain terminals and tracks on the preamplifier PCB.

When wiring up the preamplifier, make sure the AC power supply is switched off and safeguarded against accidental switching-on.

CAUTION



When wiring up the system, make sure that the power supply for the NAVIKNOT system is switched off and is safeguarded against accidental switching-on.

CAUTION



Components on the devices' PCBs are sensitive to static discharge. Take the necessary precautions to prevent electrostatic discharges.

Wire up the system according to the connection diagrams and other relevant documents provided.

If installation-specific connection diagrams have been provided for a given system, these supersede any connection information contained in standard connection diagrams.

If wiring up according to standard connection diagrams, make sure beforehand that all data and signals to receive from or transmit to external equipment comply to the NAVIKNOT Electronics Unit interface specification, 5003-0120-001.

5.3 Initial System Configuration

Configuring the CDU(s)

If one CDU is installed only, the unit requires no further configuration.

In case more than one CDU is installed, each CDU must be assigned a unique ID through its local Service Setup menu.

CDU Setup Access Code

To prevent inadvertent or unauthorized changes to the CDU configuration, the local setup menu is protected by an access codes

To access the local CDU Service Setup:

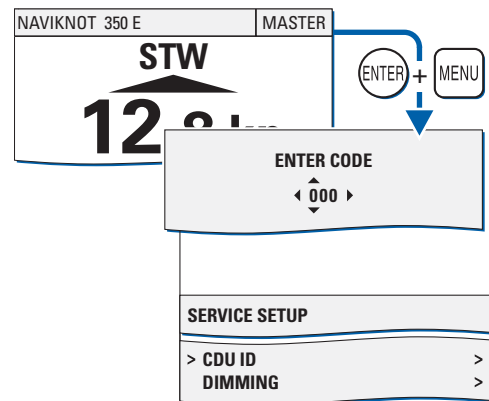

From the normal operational mode, simultaneously press **ENTER** and **MENU** to call up the CDU's local Service Setup menu mode.

When prompted for the setup code, enter code **600**.

The CDU's local Service Setup opens.

CDU Service Setup – Overview

Figure 5-1:
CDU Service Setup

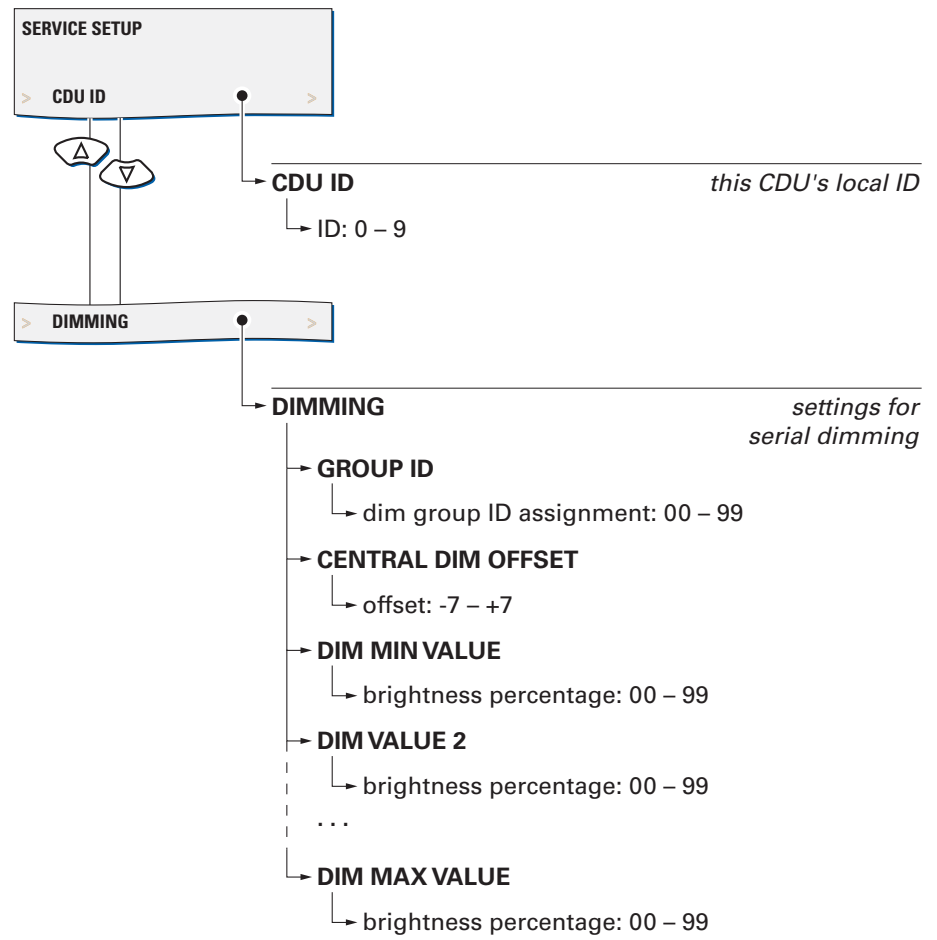

CDU Service Setup – Parameters

CDU ID

Sets the CDU's local ID.

The ID serves to identify the individual CDUs in systems where one or more remote CDUs are installed. The electronics unit uses the ID to keep track of which CDU is currently assigned master command.

Setting: **0 – 9**

Select an ID between "1" and "9" if more than one CDU is installed. A given ID may only be assigned to one CDU within the system.

In a single-CDU system, select ID "0".

Dimming

Group ID

Assigns the CDU to a dim group.

The ID setting is only effective if dimming commands are read from the proprietary NMEA sentence \$PPLAI.

Setting: **00 – 99**

Select an ID between "01" and "09" to assign the CDU to the respective dim group.

Selecting ID "00" lets the CDU accept any dim command received, regardless of group assignment.

Central Dim Offset

Sets a local offset for the brightness level.

Setting: **-7 – +7**

Select an offset as required to match the brightness of the CDU to that of other equipment controlled through the same dim command device.

Offsets below 0 decrease, offsets above 0 increase the CDU's overall brightness by the corresponding number of brightness levels. However, the offset will not alter the brightness beyond the min. and max levels respectively. The factory default for the offset is 0.

Dim Values (min. through max.)

Maps the ordered brightness setting as read from the serial dim command to the NAVIKNOT 350 E's nine discrete brightness levels.

Settings: **00 – 99**

For each brightness level, set the smallest intensity order at which the level should be active. If the order received is smaller than the set value, brightness is reduced to the next lower level.

Configuring System Parameters

When the system has been wired up, all configuration parameters are to be set to the required values in the Service Setup in order to make the NAVIKNOT system fully functional. For a description of the Service Setup, refer to Chapter 6 (System Configuration).

Note

As the first step in an initial system configuration, call up the Service Setup and the system type parameter to "NAVIKNOT 350 E". Then, quit the setup menu and cycle the power to make sure that only those parameter settings and configuration options which apply to a NAVIKNOT 350 E system are available through the Service Setup.

After the initial system configuration, note all settings in the NAVIKNOT 350 E system setup table (see Appendix). Send one copy of the filled-out table to Sperry Marine for inclusion in the ship's file.

The operating parameters in the User Setup and Manual Settings menus should also be set as required for normal operation within the given system.

Chapter 6: System Configuration

6.1 Service Setup Menu

The Service Setup menu provides access to the system parameters which configure the NAVIKNOT 350 E according to the requirements of the installation at hand.

Setup Access Code

To prevent inadvertent or unauthorized changes to the system configuration, setup menus which are to be accessed by service personnel only are protected by access codes.

To access the Service Setup:

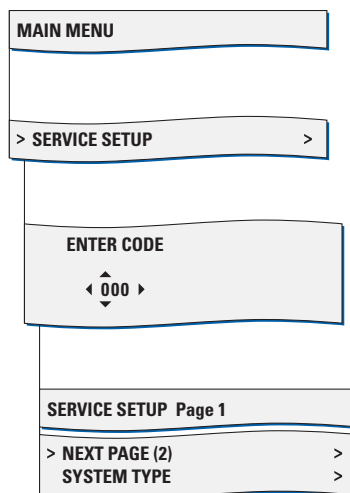

Call up the Main Menu.

Select the Service Setup.

When prompted for the setup code, enter code **600**.

Press **ENTER** to continue.

Page 1 of the Service Setup opens.

Service-Setup – Overview

Figure 6-1:
Service Setup,
page 1

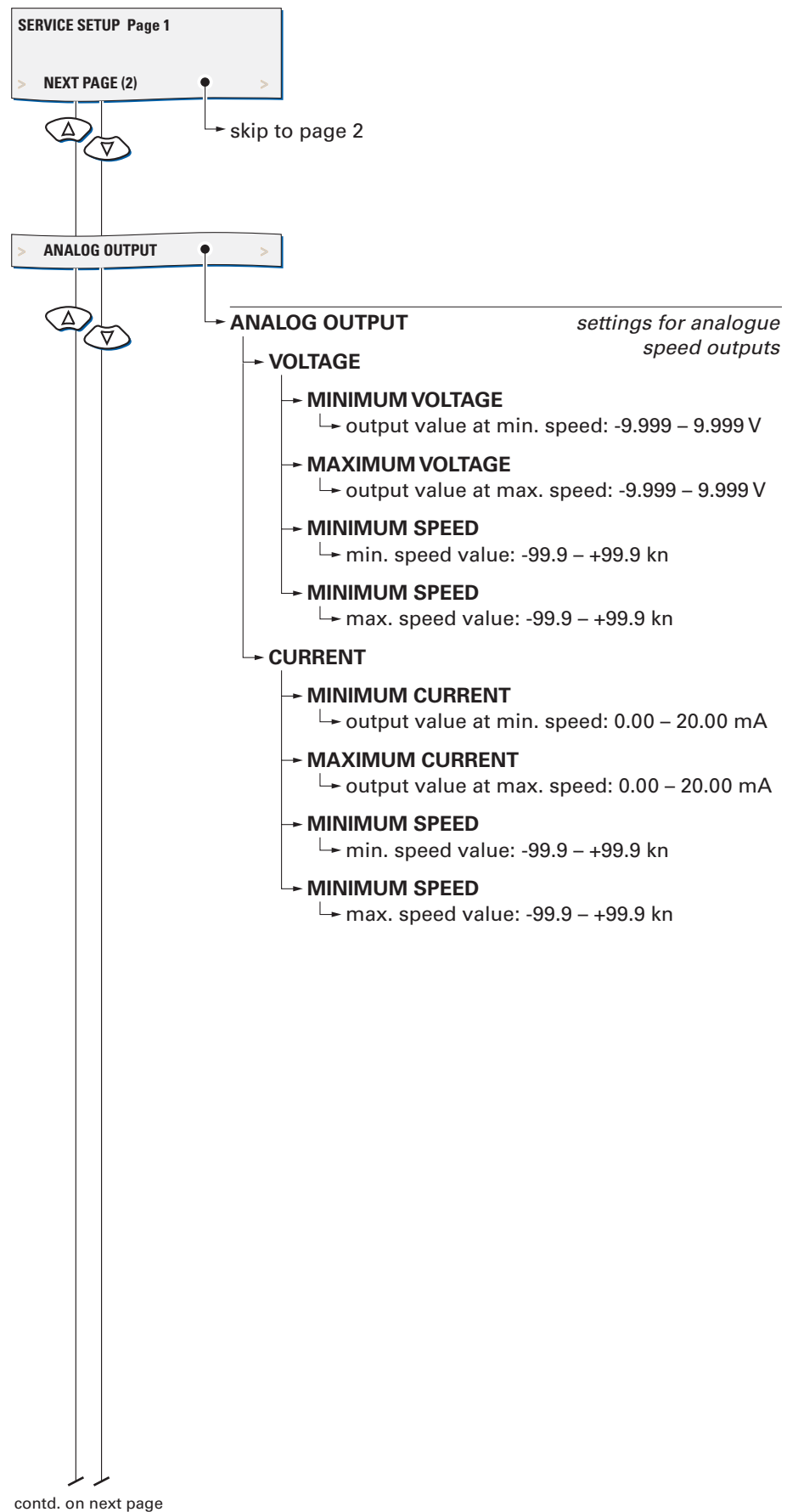

Figure 6-2:
Service Setup,
page 1 (contd.)

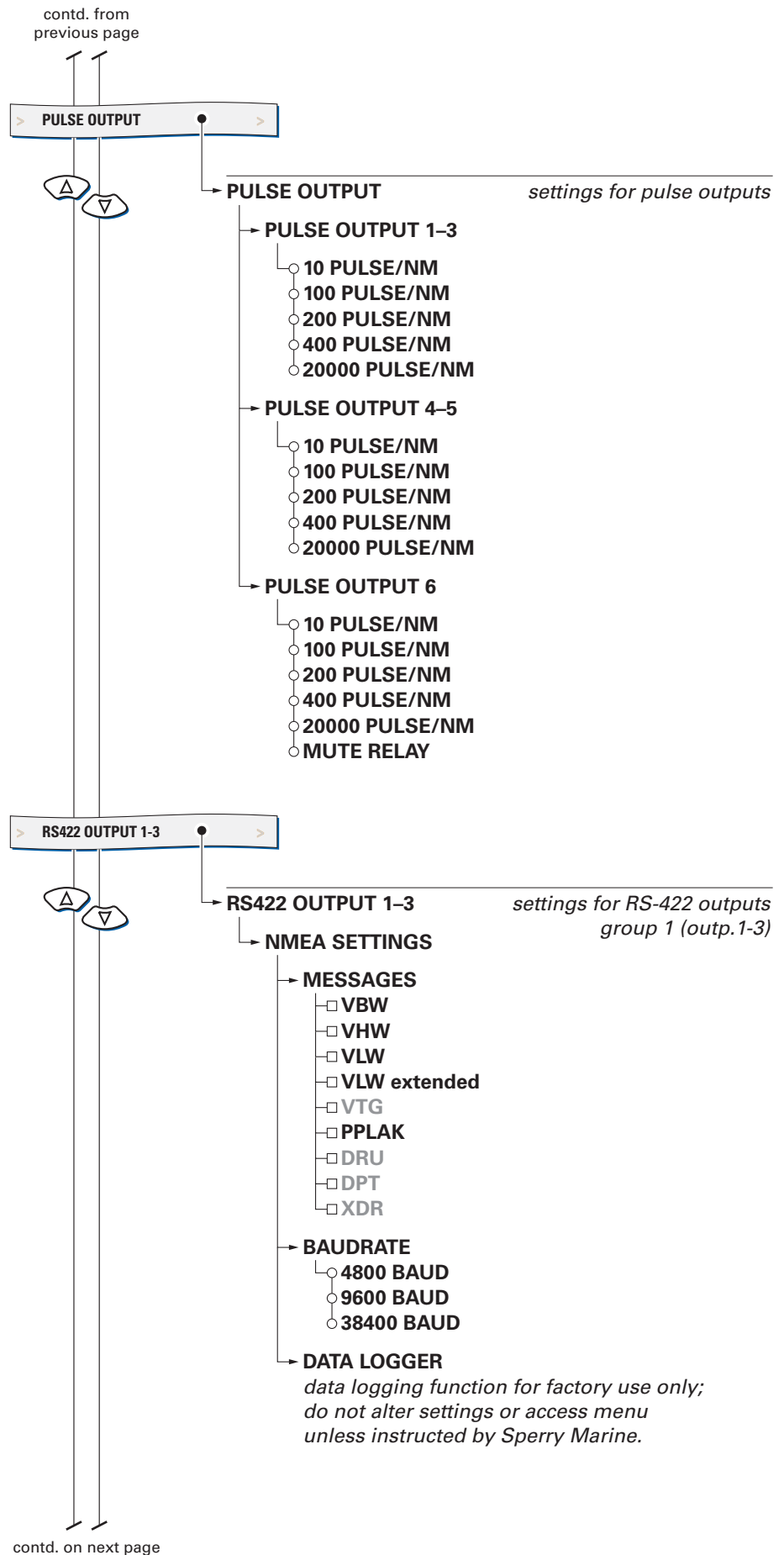

Figure 6-3:
Service Setup,
page 1 (contd.)

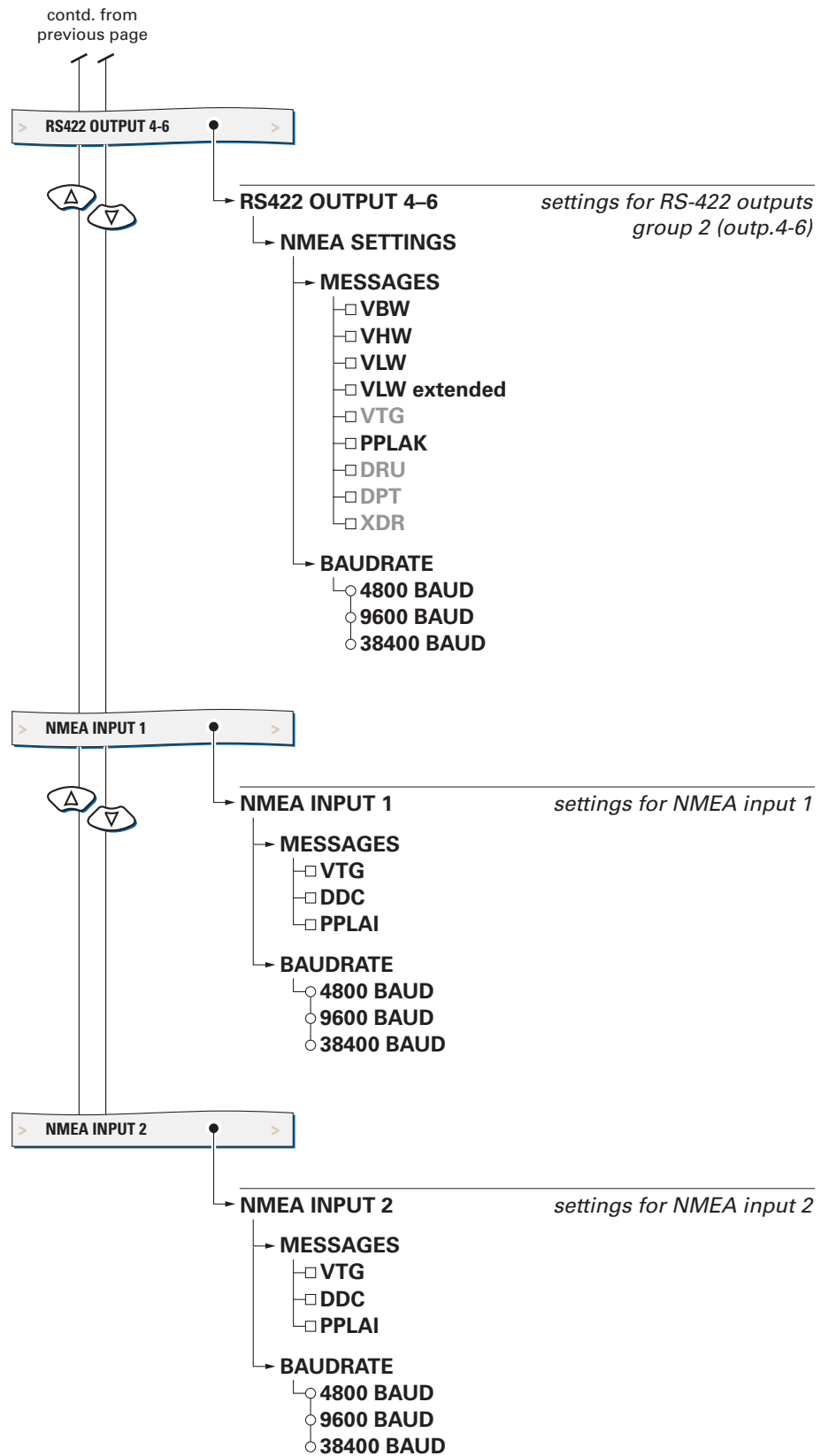
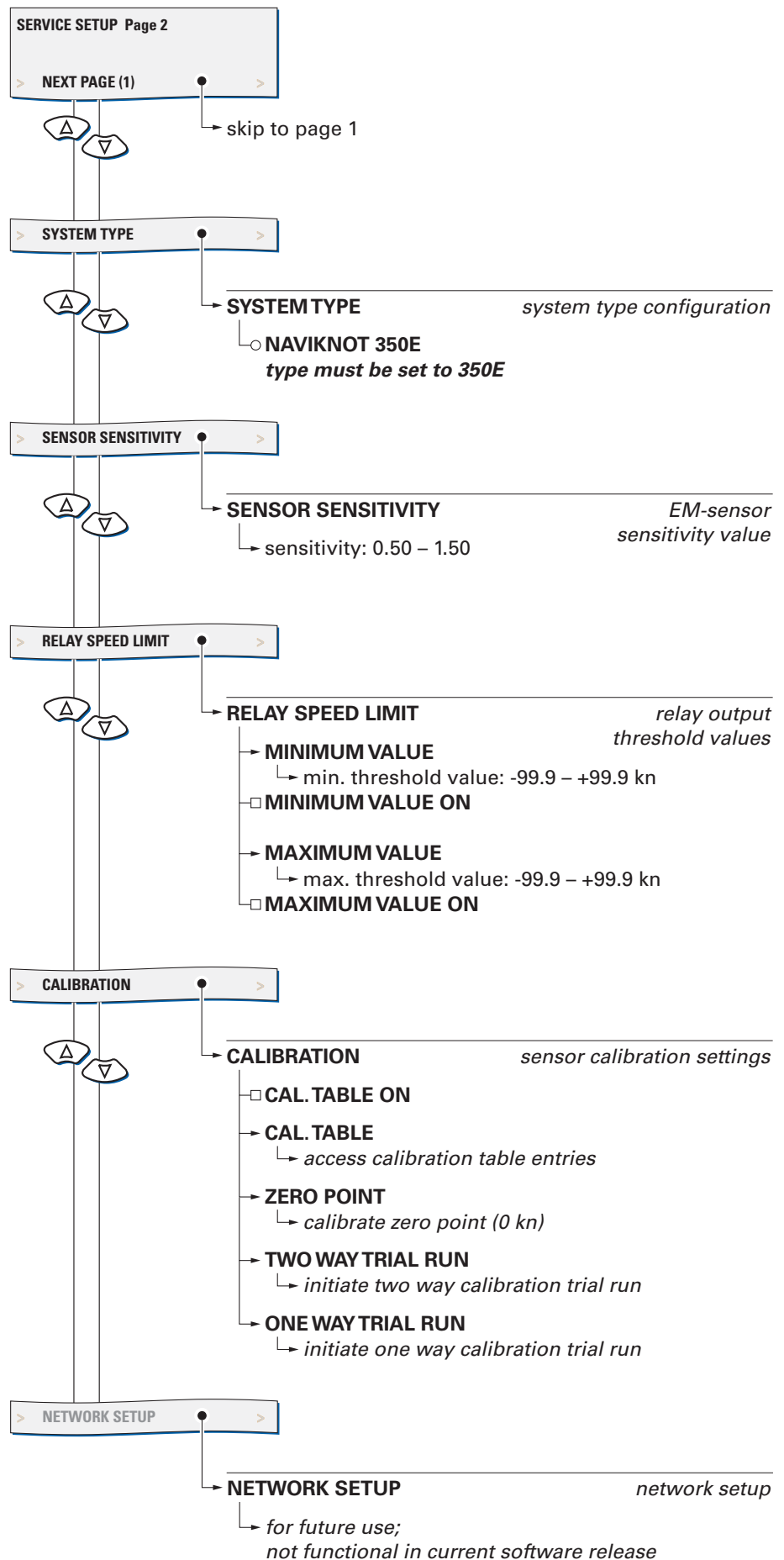

Figure 6-4:
Service Setup,
page 2



Service Setup – Parameters

Analog Output

Configures the analogue speed outputs (voltage and current output).

Voltage

Configures the analogue output voltage range.

The output voltage range is defined by two pairs of values:
The minimum speed and associated minimum voltage determine the lower limit of the output range, while the maximum speed and associated maximum voltage define its upper limit.

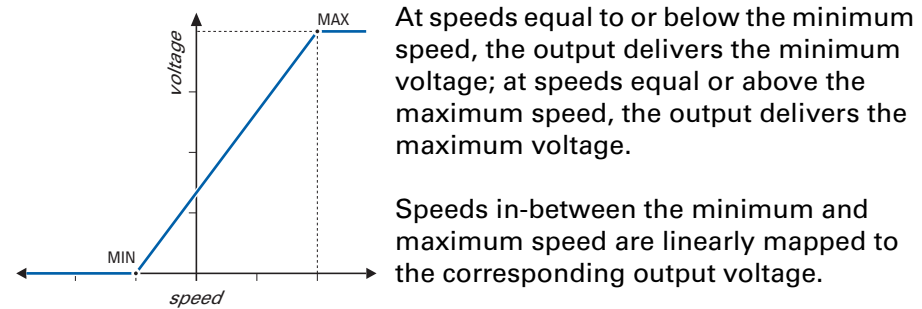

The absolute limits of the output are -9.999 V min. and 9.999 V max.

Example:

Moving coil speed indicators are to be used which are scaled from -5 kn at zero deflection to +25 kn at a full-scale deflection of 10 VDC.

The required settings are:

min. voltage = 0.000 V; min. speed = -5 kn;

max. voltage = 9.999 V; max. speed = +25 kn

Settings: **Minimum Voltage**
value: -9.999 – 9.999 VDC

Maximum Voltage
value: -9.999– 9.999 VDC

Minimum Speed
value: -99.9 – +99.9 kn

Maximum Speed
value: -99.9 – +99.9 kn

Current

Configures the analogue output current range.

The output current range is defined by two pairs of values: The minimum speed and associated minimum current determine the lower limit of the output range, while the maximum speed and associated maximum current define its upper limit.

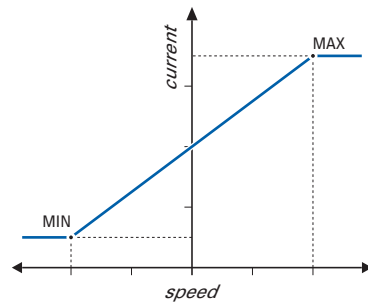

At speeds equal to or below the minimum speed, the output delivers the minimum current; at speeds equal or above the maximum speed, the output delivers the maximum current.

Speeds in-between the minimum and maximum speed are linearly mapped to the corresponding output current.

The absolute limits of the output are 0.00 mA min. and 20.00 mA max.

Example:

The speed range of -25 to +25 kn is to be mapped to a 4 – 20 mA output.

The required settings are:

min. current = 4.00 mA; min. speed = -25 kn;

max. voltage = 20.00 mA; max. speed = +25 kn

Settings: **Minimum Current**
value: **0.00 – 20.00 mA**

Maximum Current
value: **0.00 – 20.00 mA**

Minimum Speed
value: **-99.9 – +99.9 kn**

Maximum Speed
value: **-99.9 – +99.9 kn**

Pulse Output

Configures the pulse signal outputs.

The outputs are divided into three individually configurable groups. Each group may be configured to deliver 10, 100, 200, 400 or 20000 pulses per nautical mile.

The generated pulses possess a fixed "on" duty cycle of 100 ms for the 10, 100 or 200 pulse/NM setting, 50 ms for the 400 pulse/NM setting and 1 ms for the 20000 pulse/NM setting.

Group 3 (output 6) may alternatively be configured to generate an alarm mute signal. This signal, a 100 ms pulse, is used to mute the audible alarm indication at a central alarm facility when the respective alarm is acknowledged locally at the NAVIKNOT 350 E CDU.

Pulse Output 1-3

Configures group 1 of the pulse outputs (outputs 1 – 3).

Settings: **10 Pulse/NM**

The output delivers 10 pulses per nautical mile.

100 Pulse/NM

The output delivers 100 pulses per nautical mile.

200 Pulse/NM

The output delivers 200 pulses per nautical mile.

400 Pulse/NM

The output delivers 400 pulses per nautical mile.

20000 Pulse/NM

The output delivers 20000 pulses per nautical mile.

Pulse Output 4-5

Configures group 2 of the pulse outputs (outputs 4 – 5).

Settings: **10 Pulse/NM**

The output delivers 10 pulses per nautical mile.

100 Pulse/NM

The output delivers 100 pulses per nautical mile.

200 Pulse/NM

The output delivers 200 pulses per nautical mile.

400 Pulse/NM

The output delivers 400 pulses per nautical mile.

20000 Pulse/NM

The output delivers 20000 pulses per nautical mile.

Pulse Output 6

Configures group 6 of the pulse outputs (output 6).

Settings: 10 Pulse/NM

The output delivers 10 pulses per nautical mile.

100 Pulse/NM

The output delivers 100 pulses per nautical mile.

200 Pulse/NM

The output delivers 200 pulses per nautical mile.

400 Pulse/NM

The output delivers 400 pulses per nautical mile.

20000 Pulse/NM

The output delivers 20000 pulses per nautical mile.

MUTE RELAY

When an alarm is acknowledged locally at the NAVIKNOT 350 E CDU, the output delivers a pulse to mute the audible alarm indication at a central alarm facility.

RS422 Output 1-3

Configures group 1 of the RS-422 serial data outputs (outputs 1-3).

Messages

Selects the NMEA sentences to transmit.

If the NAVIKNOT 350 E cannot provide valid data for an NMEA sentence field, a null field (empty field) is sent. Status fields for invalid or unknown data are marked as invalid ("V"). The Talker ID is "VM" for all sentences except the proprietary \$PPLAK. Other sentences than those described below must not be activated for the NAVIKNOT 350 E.

Settings: **VBW**

Longitudinal water speed and status (valid/invalid) are transmitted using the \$-VBW sentence.

VHW

Longitudinal water speed is transmitted using the \$-VHW sentence.

VLW / VLW extended

The distance travelled through the water since last reset (daily miles) and total cumulative water distance (total miles) are transmitted using the \$-VLW sentence.

The "extended" form of the sentence includes trailing fields for ground distances as per IEC 61162-1:2000, the non-extended form omits these fields.

PPLAK

Log status and operating mode information is transmitted using the proprietary \$PPLAK sentence.

Baudrate

Selects the transmit baudrate.

Settings: **4800 Baud**

Data is transmitted at 4800 Baud
(standard according to NMEA / IEC 61162-1)

9600 Baud

Data is transmitted at 9600 Baud
(non-standard)

38400 Baud

Data is transmitted at 38400 Baud
(high-speed according to IEC 61162-2)

Data Logger

Access data logging functions for factory use. Field service must not alter any setting and should not access this menu unless instructed by Sperry Marine.

RS422 Output 4-6

Configures group 2 of the RS-422 serial data outputs (outputs 4-6).

Messages

Selects the NMEA sentences to transmit.

If the NAVIKNOT 350 E cannot provide valid data for an NMEA sentence field, a null field (empty field) is sent. Status fields for invalid or unknown data are marked as invalid ("V"). The Talker ID is "VM" for all sentences except the proprietary \$PPLAK. Other sentences than those described below must not be activated for the NAVIKNOT 350 E.

Settings: VBW

Longitudinal water speed and status (valid/invalid) are transmitted using the \$-VBW sentence.

VHW

Longitudinal water speed is transmitted using the \$-VHW sentence.

VLW / VLW extended

The distance travelled through the water since last reset (daily miles) and total cumulative water distance (total miles) are transmitted using the \$-VLW sentence.

The "extended" form of the sentence includes trailing fields for ground distances as per IEC 61162-1:2000, the non-extended form omits these fields.

PPLAK

Log status and operating mode information is transmitted using the proprietary \$PPLAK sentence.

Baudrate

Selects the transmit baudrate.

Settings: 4800 Baud

Data is transmitted at 4800 Baud
(standard according to NMEA / IEC 61162-1)

9600 Baud

Data is transmitted at 9600 Baud
(non-standard)

38400 Baud

Data is transmitted at 38400 Baud
(high-speed according to IEC 61162-2)

NMEA Input 1

Configures the NMEA input 1.

Messages

Selects the NMEA sentences to receive.

Settings: **VTG**

Enables the input to receive external speed data from the \$-VTG sentence. The external data is evaluated if the operator activates the "EXTERN" speed mode in the Manual Settings menu.

DDC

Dimming commands are read from the \$-DDC sentence.

PPLAI

Dimming commands are read from the proprietary \$PPLAI sentence.

Baudrate

Selects the receive baudrate

Settings: **4800 Baud**

Data is received at 4800 Baud
(standard according to NMEA / IEC 61162-1)

9600 Baud

Data is received at 9600 Baud
(non-standard)

38400 Baud

Data is received at 38400 Baud
(high-speed according to IEC 61162-2)

NMEA Input 2

Configures the NMEA input 2.

Messages

Selects the NMEA sentences to receive.

Settings: **VTG**

Enables the input to receive external speed data from the \$-VTG sentence. The external data is evaluated if the operator activates the "EXTERN" speed mode in the Manual Settings menu.

DDC

Dimming commands are read from the \$-DDC sentence.

PPLAI

Dimming commands are read from the proprietary \$PPLAI sentence.

Baudrate

Selects the receive baudrate

Settings: **4800 Baud**

Data is received at 4800 Baud
(standard according to NMEA / IEC 61162-1)

9600 Baud

Data is received at 9600 Baud
(non-standard)

38400 Baud

Data is received at 38400 Baud
(high-speed according to IEC 61162-2)

System Type

Configures the NAVIKNOT system type.

For the NAVIKNOT 350 E, the type must be set to 350E; all other options are to be ignored.

Settings: **NAVIKNOT 350E**

Sensor Sensitivity

Sets the sensitivity value for the EM-Log sensor.

The required setting is noted on a label attached to the sensor and is also recorded in the delivery documents for the sensor.

For a detailed explanation of the effect of the sensitivity setting, refer to chapter 7, "EM Sensor Calibration".

Value: **0.5 – 1.5**

Relay Speed Limit

Sets the lower and/or upper switching thresholds for the speed limit relay output.

The speed limit relay output provides a status signal to external equipment, to indicate that the actual speed has exceeded or fallen below a set threshold. This signal may be e.g. for speed-dependent rudder angle limiting or similar applications.

The switching behaviour of the limit relay is determined by the combined settings of two values, the minimum (lower threshold) and the maximum (upper threshold) value:

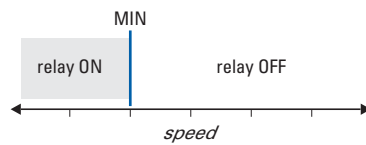

If only a minimum threshold value is set and active, the relay is attracted at speeds below and released at speeds above the threshold value.

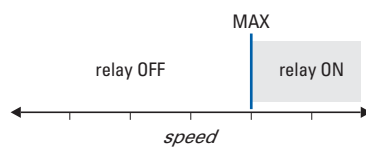

If only a maximum threshold value is set and active, the relay is attracted at speeds above and released at speeds below the threshold value.

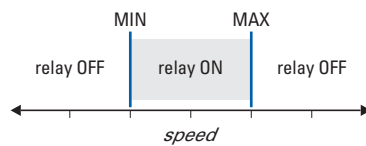

If both a minimum and a maximum threshold value are set and active, the relay is released at speeds below the min. value, attracted at speeds in-between both values and released again at speeds above the max. threshold.

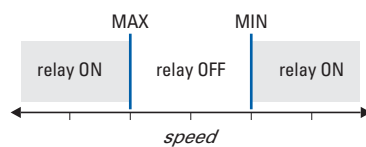

If the max. threshold is set to a value below the min. threshold, the relay is attracted at speeds below the min. value, released at speeds in-between both values and attracted again at speeds above the max. threshold.

If both threshold values are de-activated or set to exactly the same value, the limit relay function is disabled.

Minimum Value

Sets the lower switching threshold for the limit relay.

Value: **-99.9 – +99.9 kn**

Minimum Value ON

Activates or de-activates switching at the lower threshold

Settings: **ON** (option checked)
 Switching is active at the lower threshold

OFF (option unchecked)
 Switching is inactive at the lower threshold

Maximum Value

Sets the upper switching threshold for the limit relay.

Value: **-99.9 – +99.9 kn**

Maximum Value ON

Activates ore de-activates switching at the upper threshold

Settings: **ON** (option checked)
 Switching is active at the upper threshold

OFF (option unchecked)
 Switching is inactive at the upper threshold

Calibration

Turns sensor calibration on or off, edits the calibration table and accesses the calibration trial run menus.

Cal. Table On

Activates or de-activates the calibration table.

Settings: **ON** (option checked)

Calibration is active. The NAVIKNOT 350 E corrects the data received from the preamplifier E according to the calibration table. The resulting calibrated speed is displayed and transmitted at the data outputs.

OFF (option unchecked)

Calibration is disabled. The NAVIKNOT 350 E does not apply any corrections to the data received from the preamplifier E. Raw speed only is displayed and transmitted at the data outputs. The indication "Uncal" is shown on the CDU display as a reminder that calibration is disabled.

Cal. Table

Edits the calibration table entries directly.

Settings: *refer to chapter 7, "EM Sensor Calibration"; for a detailed description of the calibration and related procedures*

Zero Point

Sets the calibration zero point (correction value at a true speed of 0 kn).

Settings: *refer to chapter 7, "EM Sensor Calibration"; for a detailed description of the calibration and related procedures*

Two Way Trial Run

Accesses the sub-menu for conducting a two-way calibration trial run.

Settings: *refer to chapter 7, "EM Sensor Calibration"; for a detailed description of the calibration and related procedures*

One Way Trial Run

Accesses the sub-menu for conducting a one-way calibration trial run.

Settings: *refer to chapter 7, "EM Sensor Calibration"; for a detailed description of the calibration and related procedures*

Network Setup

This option is reserved for future applications. Settings are not relevant and have no effect in the current software release.

Chapter 7: EM Sensor Calibration

Once the NAVIKNOT 350 E system has been installed and the basic configuration carried out, the EM sensor must be calibrated to make sure that the system’s speed and distance outputs meet the specified accuracy.

7.1 Sensor Sensitivity Setting

Upon installation or exchange of the speed sensor, the sensor’s sensitivity value must be stored in the NAVIKNOT 350 E electronics unit.

Sensitivity is a characteristic property of the individual sensor installed and is noted on a label attached to the sensor. It is also recorded in the delivery documents for the given sensor.

The sensitivity value is a dimensionless number for the ratio between the sensor’s return signal and the nominal standard of 180 μ VAC/kn. Typical values for EM sensors range from 0.7 to 1.14.

Figure 7-1:
effect of the
sensor sensitivity

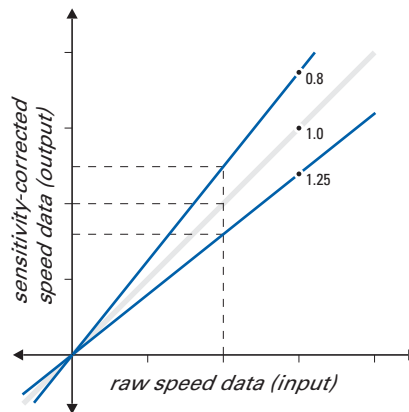

Note



When checking the effect of the sensitivity setting, bear in mind that the value does not equal the gain applied but, rather, its reciprocal. Thus, for example, a sensitivity value of 0.8 multiplies the raw speed by 1.25, while a value of 1.25 multiplies it by 0.8.

To set the sensitivity value:

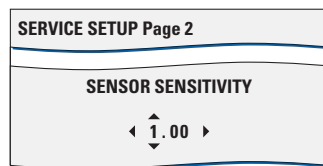

1. Go to page 2 of the Service Setup and select the Sensor Sensitivity sub-menu.
2. With the **Up/Down** and **Right/Left** keys, set the sensitivity as required.
3. press **ENTER** to store the value and exit the sub-menu.

7.2 EM Sensor Calibration

To minimize the deviation between the vessel's actual water speed and the speed displayed and transmitted, the NAVIKNOT 350 E stores sensor-specific calibration data in a so-called calibration table.

The calibration table holds up to 21 entries ("calibration points"), each of which relates an uncalibrated raw value to a corresponding true water speed value. The entries holding the lowest and highest uncalibrated values determine the range over which calibration is effective.

Note



To calibrate speeds astern, at least one calibration point with a negative uncalibrated speed value must be stored. Otherwise, calibration is effective for speeds ahead only.

The effects of setting calibration points (i.e. adding entries to the calibration table) at different states of calibration are illustrated below.

Figure 7-2:
effect of calibration
table entries

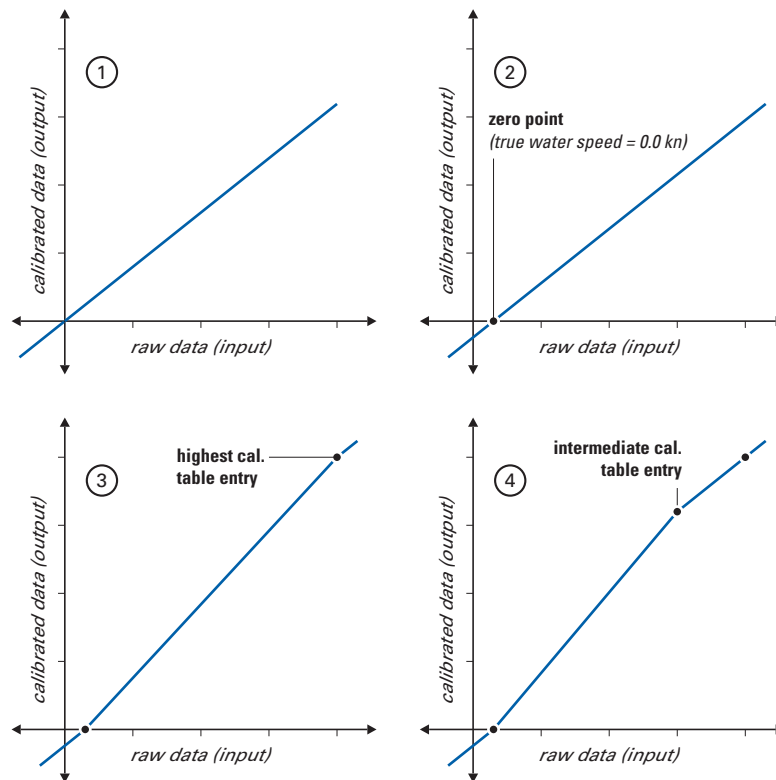

- ① calibration table empty:
linear sensor characteristic assumed;
display and output = 0.0 kn at raw sensor data value of 0.0 kn
- ② zero point calibrated
linear sensor curve is offset by zero point calibration value
- ③ one additional point calibrated (highest table entry)
calibration points joined by straight line (linear interpolation)
- ④ additional intermediate points calibrated
calibrated range is split into linear segments of different slope

Editing the Calibration Table Directly

To add, edit or delete calibration points directly, go to page 2 of the Service Setup and select the Calibration | Cal.Table sub-menu. The data stored at calibration point no. 00 is shown (dashes will appear if the table is empty).

To add or edit a calibration point:

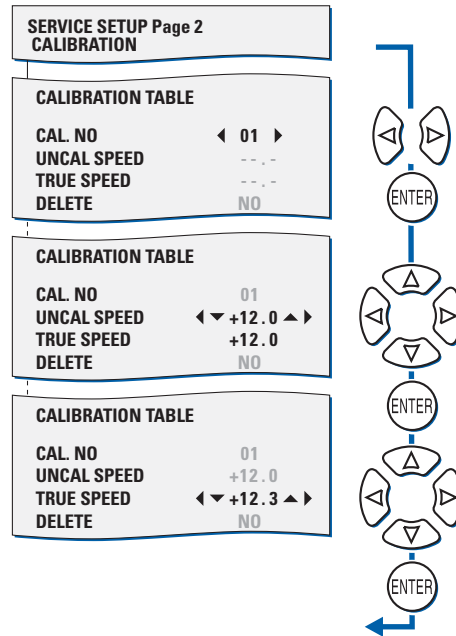

1. With the **Right/Left** keys, select the calibration point to add or edit. Press **ENTER** to continue.
2. With the **Up/Down** keys (knots) and the **Right/Left** keys (tenths of knots), set the uncalibrated speed to the required value. The true speed indication is altered by the same amount. Press **ENTER** to continue.
3. With the **Up/Down** keys and the **Right/Left** keys, now alter the true speed indication as required. The uncalibrated speed value is not altered. Press **ENTER** to store the edited data.

4. Press **ENTER** again to continue editing or **MENU** to quit the Cal.Table sub-menu.

To delete a calibration point:

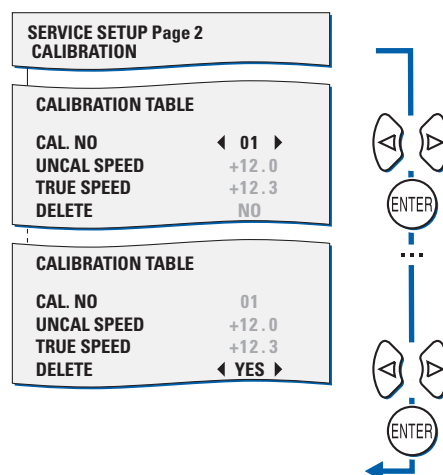

5. With the **Right/Left** arrow keys, select the calibration point to delete.
6. With **ENTER**, go down to the "delete" option, press the **Right** or **Left** key to select "yes"; then press **ENTER** to delete the calibration point.
7. Select another calibration point to delete or press **MENU** to quit the Cal.Table sub-menu.

Note



Upon quitting the Cal. Table sub menu, the entries are sorted and renumbered according to their uncalibrated speed values. Point 00 always holds the entry with the smallest uncalibrated speed value.

Zero Point Calibration

Before any entries for non-zero speeds are stored in the calibration table or calibration trial runs are conducted, the zero point calibration should be carried out.

The “zero point” refers to the calibration table entry which holds the uncalibrated (“raw”) speed value corresponding to a true water speed of zero knots. Two methods are available to calibrate the zero point: manual and auto.

Note



Both the manual and the automatic zero point calibration require that the vessel is stationary.

Manual Entry

The manual entry method permits zero point calibration in waters which are not free of current. However, the longitudinal component of the current must be known and it must be small enough to regard the sensor as operating near zero speed.

To carry out the manual zero-point calibration:

1. Go to page 2 of the Service Setup; select the Calibration | Zero Point | Man Calibration sub-menu.

Three values are shown, the true speed, the uncalibrated speed and the calibration value (i.e. the difference of the two speeds).

The uncalibrated speed is the raw speed value as currently received from the EM sensor (not editable).

The objective of the calibration is now to alter the calibration value until the displayed true speed value matches the known actual water speed.

Thus, in waters free of current, the displayed true speed value must be brought to zero; in the presence of current, the true speed value must be made equal to the known longitudinal component of the current.

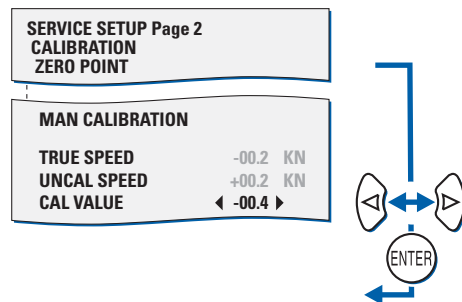

2. With the **Right/Left** arrow keys, alter the calibration value until the displayed true speed exactly matches the known actual water speed.
3. Press **ENTER** to confirm the setting and leave the manual calibration sub-menu.

Note



When the manual entry is stored, the true speed entered is automatically subtracted from both the uncalibrated and true speed values. Thus, the entry written to the table will always contain the uncalibrated value corresponding to a true speed of zero knots.

Automatic Entry

With the automatic entry method, the required zero point setting is determined automatically. Automatic entry may only be used when the vessel is stationary in waters free of current, i.e., if the actual water speed is known to be zero.

To carry out the automatic zero-point calibration:

1. Go to page 2 of the Service Setup;
select the Calibration | Zero Point | Auto Calibration sub-menu.

As with the manual entry method, the true speed, the uncalibrated speed and the calibration value are shown.

However, the true speed value is fixed to zero knots and cannot be adjusted by the operator. The uncalibrated speed is the raw speed value as currently received from the EM sensor, thus the calibration value will be equal to the uncalibrated speed with the sign reversed.

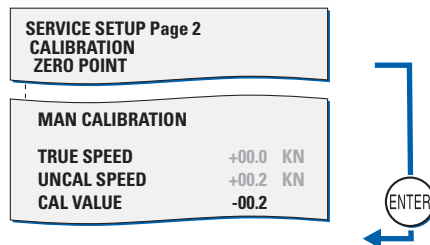

2. Press **ENTER** to confirm the setting and leave the auto calibration sub-menu.

Calibration by Trial Runs

Calibration by trial runs is the recommended method to calibrate the EM-sensor in the NAVIKNOT 350 E. system. The procedure resembles the familiar "milepost run", but permits any known distance to be taken as the length of a run.

The known distance may be given by the distance between sidebearings to prominent landmarks. The regular procedure in this case is to start and stop the run clock exactly at the points in time when the landmarks are sighted athwartships.

If landmarks cannot be used, the known distance will usually be obtained from a reference system (e.g. DGPS) operated by a supervisor who will also announce when to start and stop the run clock.

Generally, for each correction value to be determined, a two way trial run should be carried out, i.e. the same known distance "l" should be traversed in opposite directions (runs A and B). This will make the effects of drift due to wind and current cancel out each other automatically. Only when no wind and current are present, a one way trial run may be carried out.

The first two or one way trial run should be carried out at maximum sea speed, to define the upper limit of the calibrated range. Additional trial runs may be carried out later at lower speeds to improve the accuracy within the calibrated range.

Figure 7-3:
calibration
by trial runs

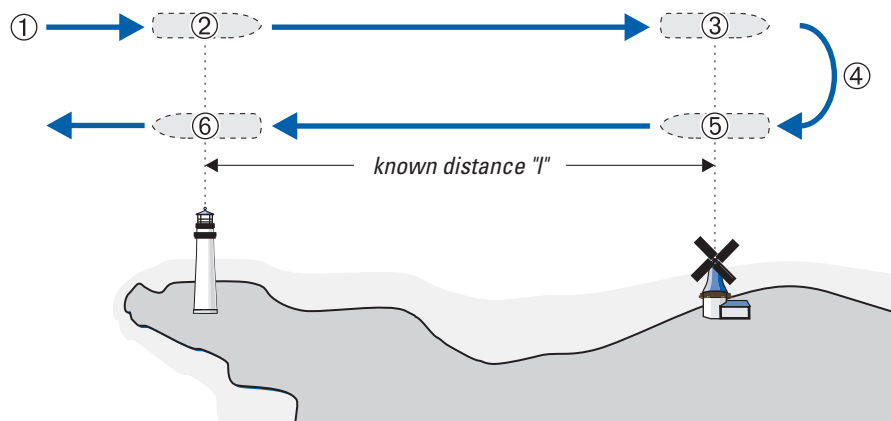

- ① approach to run A or one-way run
- ② start of run A or one-way run
- ③ end of run A or one-way run
- ④ approach to run B
- ⑤ start of run B
- ⑥ end of run B

Two Way Trial Run

Note



During a two way trial run, the vessel's heading during runs A and B should ideally be parallel to the direction of the effective drift, as the drift component perpendicular to the heading cannot be compensated for.

To carry out a two way trial run:

1. Bring the vessel on the required course for the approach to run A.
2. Approach the run with the speed (engine rev.s) at which the calibration is to be carried out. Keep the heading and speed steady.
3. Go to page 2 of the Service Setup and select the Calibration | Two Way Trial Run sub-menu.
The run clock is shown, indicating 00:00 s run time and the uncalibrated water speed as received from the EM sensor.

SERVICE SETUP Page 2 CALIBRATION	
TWO WAY TRIALRUN	
TIME	00:00 S
SPEED	20.2 KN

TIME	00:02:30 S
SPEED	20.2 KN

DISTANCE	◀ 01.000 NM ▶
UNCAL SPEED	20.2 KN
TRUE SPEED	20.0 KN
CAL VALUE	-0.2



4. Exactly at the start of run A (first landmark athwartships or "start" announced by supervisor), press **ENTER** to start the run clock.
5. Exactly at the end of run A (second landmark athwartships or "stop" announced by supervisor), press **ENTER** to stop the run clock.

The display now indicates the run distance (editable), the average uncalibrated speed for the run, the true speed over ground (calculated from the run time and distance) and the calculated calibration value.

6. With the **Right/Left** arrow keys, alter the distance value until the distance displayed exactly matches the known distance "I" over ground as taken from the sea chart or given by the supervisor. Press **ENTER** to store the run parameters.

The run clock is shown again, indicating 00:00 s run time and the uncalibrated water speed as received from the EM sensor.

7. Turn the vessel around and bring it on the required course for the approach to run B. This is the exact reverse of the course maintained during run A.
Approach the run with the same speed (engine rev.s) at which run A was carried out. Keep the heading and speed steady.

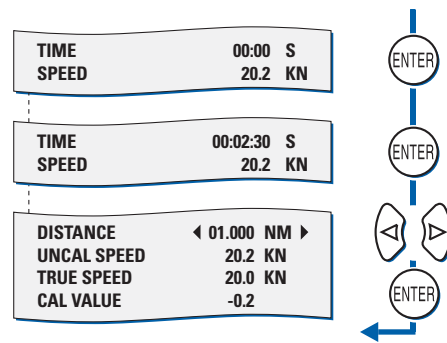

8. Exactly at the start of run B (second landmark athwartships or "start" announced by supervisor), press **ENTER** to start the run clock.
9. Exactly at the end of run B (first landmark athwartships or "stop" announced by supervisor), press **ENTER** to stop the run clock.

The display again indicates the run distance, the average uncalibrated speed, the true speed over ground and the calculated calibration value.

10. With the **Right/Left** arrow keys, alter the distance value until the distance displayed exactly matches the known distance "1" over ground as taken from the sea chart or given by the supervisor. Press **ENTER** to store the run parameters.

The Two Way Trial Run sub-menu is quit automatically.

As the result of the two way trial run, one new entry will now be found in the calibration table.

The uncalibrated speed stored at this entry is the average of the two averaged uncalibrated speeds from run A and run B.

The true speed stored at this entry is the average of the two true speeds calculated for run A and run B.

One Way Trial Run

Note



In a one way trial run, any drift due to wind and/or current will adversely affect the calibration. Conducting a one way trial run in the presence of drift, may degrade instead of improve the speed accuracy.

To carry out a one way trial run:

1. Bring the vessel on the required course for the approach to the run.
2. Approach the run with the speed (engine rev.s) at which the calibration is to be carried out. Keep the heading and speed steady.
3. Go to page 2 of the Service Setup and select the Calibration | One Way Trial Run sub-menu.
The run clock is shown, indicating 00:00 s run time and the uncalibrated water speed as received from the EM sensor.

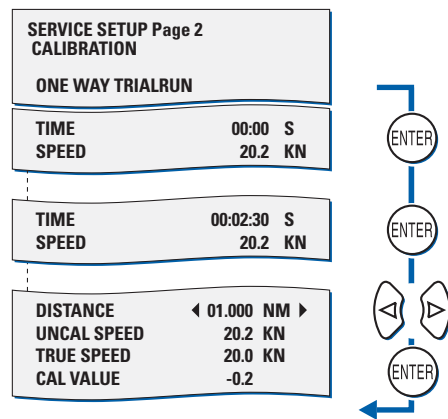

4. Exactly at the start of the run (first landmark athwartships or “start” announced by supervisor), press **ENTER** to start the run clock.
5. Exactly at the end of the run (second landmark athwartships or “stop” announced by supervisor), press **ENTER** to stop the run clock.

The display now indicates the run distance (editable), the average uncalibrated speed for the run, the true speed over ground (calculated from the run time and distance) and the calculated calibration value.

6. With the **Right/Left** arrow keys, alter the distance value until the distance displayed exactly matches the known distance “1” over ground as taken from the sea chart or given by the supervisor. Press **ENTER** to store the run parameters.

The One Way Trial Run sub-menu is quit automatically.

As the result of the trial run, one new entry will now be found in the calibration table, holding the average uncalibrated speed and the calculated true speeds for the run.

Chapter 8: Troubleshooting

8.1 NAVIKNOT Electronics Unit and CDU(s)

The NAVIKNOT 350 E electronics unit and the CDU are complex electronic devices. In case of malfunction, it would neither be practical nor economical to carry out troubleshooting and servicing in the field down to the level of individual circuit components.

Unless instructed otherwise by Sperry Marine engineering, field service personnel should limit troubleshooting to the basic checks given below.

- For the electronics unit:
 - Visual inspection of mechanical components, the electronics unit PCB and wiring.
 - Continuity checks of wiring connections.
 - Checks for short circuit or overload conditions or reversed polarity of the external supply powers.
 - Checks of the on-board supply voltages and I/O signals and data. The presence of voltages, signals and data is indicated by diagnostic LEDs on the PCB.
Exact voltage levels must be checked with a voltmeter.
The data content on serial I/O lines must be checked with the aid of suitable analyzing tools, such as PC-based protocol interpreters or terminal programs.

When components on the PCB, other than socketed ICs or the exchangeable system software flashboard, are assumed to cause malfunction, the complete PCB, Stock No. 20692, is to be exchanged.

- For the CDU(s):
 - Visual inspection of mechanical components and wiring.
 - Continuity checks of wiring connections at the terminals or terminal block to which the 6-wire CDU connection cable is fastened.
 - Checks for the presence and correct polarity of the external supply power.

The CDU is not field-serviceable and should not be opened for troubleshooting purposes. Defective CDUs must be sent back to Sperry Marine for repair.

Location of Parts on the Electronics Unit PCB

Figure 8-1 below shows the locations of exchangeable components, connectors and diagnostic LED indicators on the NAVIKNOT 350 E electronics unit PCB.

Figure 8-1:
location of parts on the electronics unit PCB

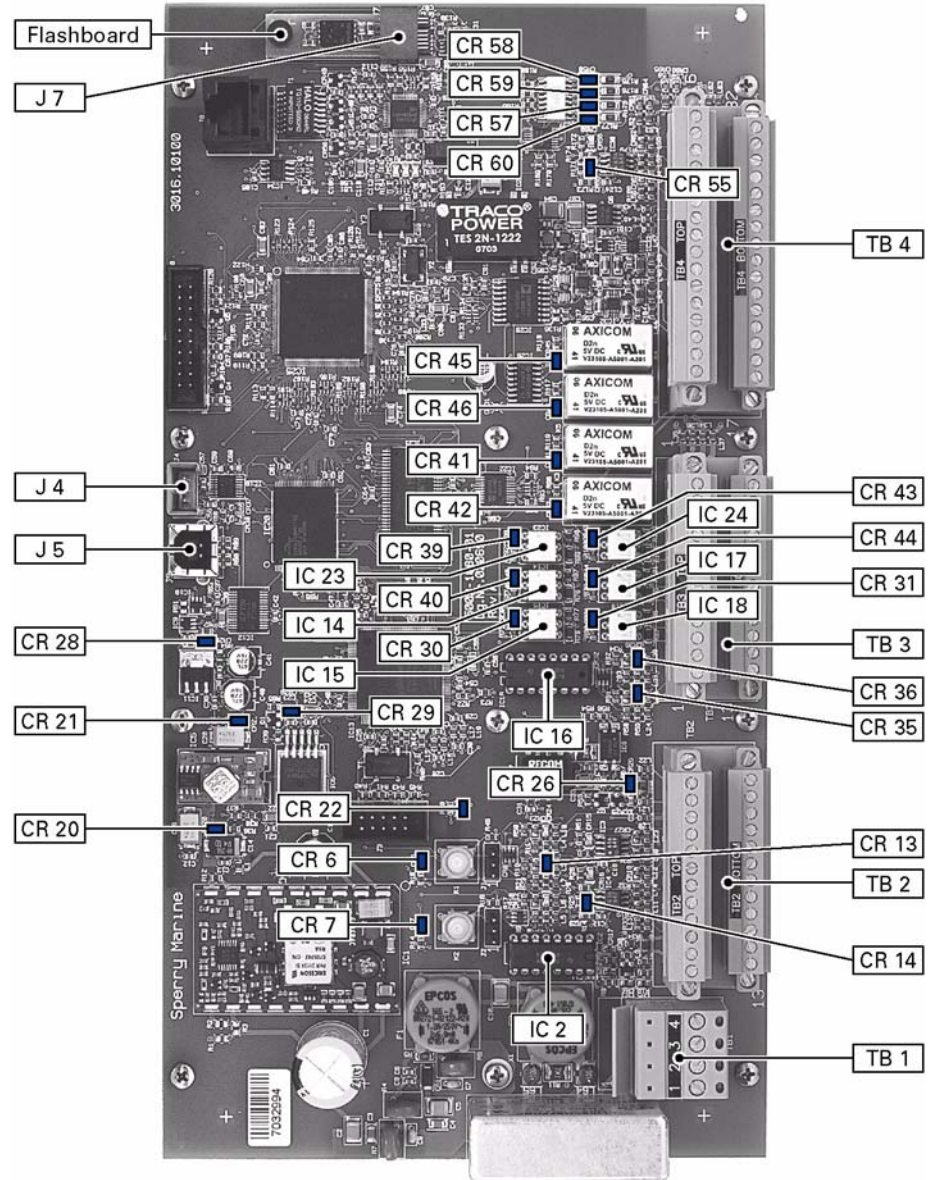

Exchangeable Components

Table 8-1:
Exchangeable
components on the
electronics unit PCB

Part	Function	Stock No.
Flash-board	Flashboard (flash-memory card), pre-programmed with system software	020705-0000-000
IC 2	quad RS-422 output driver IC; drives serial data RS-422 outputs 1 to 3	046485-0000-000
IC 14	photocoupler/photo relay; pulse output 1 contact closure	042842-0000-000
IC 15	photocoupler/photo relay; pulse output 2 contact closure	042842-0000-000
IC 16	quad RS-422 output driver IC; drives serial data RS-422 outputs 4 to 6	046485-0000-000
IC 17	photocoupler/photo relay; pulse output 3 contact closure	042842-0000-000
IC 18	photocoupler/photo relay; pulse output 4 contact closure	042842-0000-000
IC 23	photocoupler/photo relay; pulse output 5 contact closure	042842-0000-000
IC 24	photocoupler/photo relay; pulse output 6 contact closure	042842-0000-000

Terminal Boards and Connectors

Table 8-2:
Terminal boards and
connectors on the
electronics unit PCB

	Function
TB 1	24 VDC supply power in/out
TB 2	speed sensor interfaces, CDU interfaces
TB 3	serial data and pulse outputs
TB 4	analogue outputs, status in-/outputs, ext. data inputs
J 4	RS-232 service interface connector
J 5	USB programming connector (for factory use only)
J 7	Socket for exchangeable system software flashboard

Diagnostic LEDs

As an aid in troubleshooting, a number of diagnostic LED indicators are provided on the NAVITWIN IV PCB. These indicate the presence of supply voltages, activities on the serial data I/O lines and the current states of the status I/O ports.

Table 8-3:
Diagnostic LEDs

LED	Colour	Indication
CR 6	red	CPU status indicator, normally off, flashes at boot-up
CR 7	red	CPU status indicator, normally off, flashes at boot-up
CR 13	green	activity on Tx line, CDUs, TB 2.15/2.16, 2.19/2.20
CR 14	green	activity on Rx line, CDUs, TB 2.13/2.14, 2.17/2.18
CR 20	green	internal +12 VDC supply power present
CR 21	green	internal +5 VDC supply power present
CR 22	red	CPU status indicator, normally off, flashes at boot-up
CR 28	green	internal +3.3 VDC supply power present (Vcc)
CR 29	green	internal +1.2 VDC reference present
CR 30	green	pulse relay output active, outp. 2, TB 3.15/3.16
CR 31	green	pulse relay output active, outp. 1, TB 3.13/3.14
CR 35	green	activity on Tx line, serial data outputs group 1, TB 3.1/3.2, 3.3/3.4, 3.5/3.6
CR 36	green	activity on Tx line, serial data outputs group 2, TB 3.7/3.8, 3.9/3.10, 3.11/3.12
CR 39	green	pulse relay output active, outp. 6, TB 3.23/3.24
CR 40	green	pulse relay output active, outp. 4, TB 3.19/3.20
CR 41	green	relay output active, log failure alarm, TB 4.19/4.20
CR 42	green	relay output active, power failure alarm, TB 4.17/4.18
CR 43	green	pulse relay output active, outp. 5, TB 3.21/3.22
CR 44	green	pulse relay output active, outp. 3, TB 3.17/3.18
CR 45	green	relay output active, watch alarm trigger, TB 4.23/4.24
CR 46	green	relay output active, speed limit, TB 4.21/4.22
CR 55	green	activity on Rx line, serial dim input, TB 4.28/4.29
CR 57	green	status input active, double ended ferry, TB 4.11/4.12
CR 58	green	status input active, ext. dim+, TB 4.15/4.16
CR 59	green	status input active, ext. dim-, TB 4.13/4.14
CR 60	green	status input active, ext. alarm mute, TB 4.9/4.10

8.2 EM Sensor and Preamplifier

Malfunction of the EM sensor, resulting in a "Sensor1 Failure" alarm being given, may be caused by a mechanical or electrical defect in the sensor or by a defective preamplifier. As the preamplifier contains no built-in test circuitry, only a basic electrical check is possible in the field.

The applicable troubleshooting procedures are described in the installation, maintenance and service instructions for the respective sensor. The following documents apply:

- Sensor NF: document no. 002829-0125-001;
- Sensor FNF I: document no. 004040-0125-001;
- Sensor FNF II: document no. 004120-0125-001;
- Sensor FNF III: document no. 004874-0125-001.

Chapter 9: Corrective Maintenance

The NAVIKNOT 350 E CDU, the electronics unit and the preamplifier are generally not field-serviceable on the component level. Defective devices must be sent back to Sperry Marine for repair.

The only corrective maintenance procedures which may be performed by field service personnel are the exchange of the system software in the electronics unit and the replacement of the RS-422 output drivers and the pulse output relays.

CAUTION



The NAVIKNOT 350 E electronics unit contains electrostatic sensitive components.

Electrostatic discharge may permanently damage components.

When servicing the electronics unit, take precautions to prevent electrostatic discharge. Avoid touching any of the electronic circuitry.

9.1 Exchanging the System Software

Downloading Software from the Flashboard

The NAVIKNOT 350 E electronics unit keeps two separate copies of the system software, one in an onboard flash memory and the other on the exchangeable software flashboard 20705.

The system always boots up from the onboard memory. Should, at power-up, a different software version be found on the flashboard than is currently stored onboard, the software from the flashboard is automatically copied to the onboard memory and the system is restarted.

This allows both to upgrade to newer and to downgrade to previous releases by simply exchanging the flashboard.

CAUTION



It cannot be guaranteed that parameters settings in the User and Setup menus and the currently active manual settings are left intact during the software download.

Before exchanging the flashboard, record all settings to be able to re-enter them manually, if required.

Exchanging the Flashboard

1. Power down the NAVIKNOT 350 E system.
2. Open the electronics unit and locate the old flashboard in its socket (J7) on the PCB.

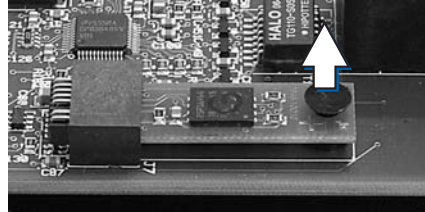

3. Carefully remove the plastic pin which secures the flashboard to the PCB.
4. Pull the old flashboard out of the socket, making sure to touch it at the edges only.

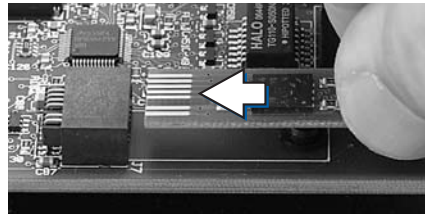
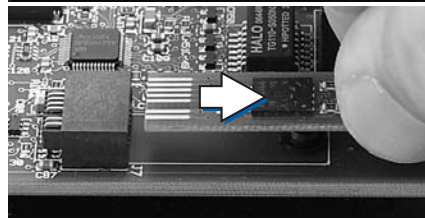

5. Insert the new flashboard into the socket.
6. Secure the flashboard with the plastic pin.

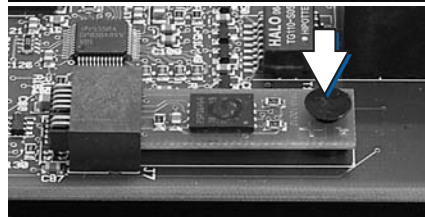

7. Power-up the NAVIKNOT 350 E system.
8. The electronics unit will recognize the new flashboard and download the updated software to the onboard memory.



9. The CDU shows the "waiting for main unit" message for several minutes while the software is downloaded. During the download, the LEDs CR 6, 7 and 22 on the electronics unit PCB will flash in sequence. Upon completion of the download, the system automatically restarts.

CAUTION



Do not disconnect power or otherwise interrupt the power-up process after an exchange of the flashboard.

Uploading Software via the Service Interface

The system software may also be uploaded from a PC or laptop via the RS-232 service interface on the electronics unit PCB.

At the time of writing of this manual, however, an upload program for field service use is not yet available. Sperry Marine will issue an official Service Bulletin as soon as such a program becomes available.

9.2 Replacing RS-422 Output Driver ICs

The RS-422 output drivers, ICs 2 and 16, are socketed 16-pin DIL chips. If failure or malfunction of RS-422 outputs is attributed to a defective driver IC, the respective chip can easily be replaced against a new one.

The driver ICs are standard quadruple RS-422 line drivers (MC3487), available from Sperry Marine Hamburg under part no. 46485.

9.3 Replacing Pulse Output Relays

The pulse output relays, ICs 14, 15, 17, 18, 23 and 24, are socketed solid state relays in a 6-pin DIL package.

If failure of a pulse output is attributed to a defective relay, the respective component can easily be replaced against a new one.

The pulse relays are photocoupler photo relays (TLP 598G), available from Sperry Marine Hamburg under part no. 42842.

Appendix

A Setup and Configuration Tables

The following tables (blank forms) are appended to this manual:

Designation	Drawing No.
NAVIKNOT 350 E Setup Table	5003-0125-01
NAVIKNOT 350 E Record of Calibration Trial Runs	5003-0125-04

Note



After installation of the NAVIKNOT 350 E, please return a filled-out copy of the Setup Table to Sperry Marine for inclusion in the ship's file. When permanent changes are made to the system configuration, please return an updated copy of the Setup Table to Sperry Marine.

B Drawings

The following drawings are appended to this manual:

Designation	Drawing No.
NAVIKNOT Electronics Unit Dimension Drawing	5003-0112-01
NAVIKNOT Control and Display Unit (in housing with bracket) Dimension Drawing	5001-0112-01
NAVIKNOT Control and Display Unit (for console frame or panel mounting) Dimension Drawing	5001-0112-02
Console Frame Layout NAVIKNOT CDU Dimension Drawing	0021-0112-86
Console Cutout 2x1 Dimension Drawing	0012-0112-02
Electromagnetic Log NAVIKNOT 350 E Standard Connection Drawing	5001-0153-11

Note



All appended documents and drawings are revision-controlled separately at Sperry Marine. In case of doubt, verify the current revision status of the drawings with Sperry Marine. This manual's revision status does not change when the revision of an appended document or drawing changes.

**NAVIKNOT 350 E
Setup Table**

Vessel: _____ Hull No.: _____

IMO No.: _____ Shipyard: _____

Service Station / Installer: _____ Date / Signature: _____

_____ / _____

CDU Configuration (local CDU setups)

CDU1, ID: _____ CDU2, ID: _____ CDU3, ID: _____ CDU4, ID: _____

Dim Grp.: _____ Dim Grp.: _____ Dim Grp.: _____ Dim Grp.: _____

User Setup

Damping Times

Display (s): _____

Output (s): _____

LCD Color

white

blue

black

Speed Scale

kn

m/s

ft/s

Service Setup - Page 1

Analog Output

Voltage

Min. Voltage (V): _____ Max. Voltage (V): _____

Min. Speed (kn): _____ Max. Speed (kn): _____

Current

Min. Current (mA) _____ Max. Current (mA): _____

Min. Speed (kn): _____ Max. Speed (kn): _____

Pulse Output

Pulse Output 1-3

- 10 Pulse/NM
- 100 Pulse/NM
- 200 Pulse/NM
- 400 Pulse/NM
- 20000 Pulse/NM

Pulse Output 4-5

- 10 Pulse/NM
- 100 Pulse/NM
- 200 Pulse/NM
- 400 Pulse/NM
- 20000 Pulse/NM

Pulse Output 6

- 10 Pulse/NM
- 100 Pulse/NM
- 200 Pulse/NM
- 400 Pulse/NM
- 20000 Pulse/NM
- Mute Relay

RS-422 Output 1-3

Messages

- VBW
- VHW
- VLW
- VLW extended
- PPLAK

Baudrate

- 4800 Baud
- 9600 Baud
- 38400 Baud

RS-422 Output 4-6

Messages

- VBW
- VHW
- VLW
- VLW extended
- PPLAK

Baudrate

- 4800 Baud
- 9600 Baud
- 38400 Baud

NMEA Input 1

Messages

- VTG
- DDC
- PPLAI

Baudrate

- 4800 Baud
- 9600 Baud
- 38400 Baud

NMEA Input 2

Messages

- VTG
- DDC
- PPLAI

Baudrate

- 4800 Baud
- 9600 Baud
- 38400 Baud

Service Setup - Page 2

System Type NAVIKNOT 350 E

Sensor Sensitivity Value: _____

Relay Speed Limit Min.Value (kn): _____ Min. Value ON
Max.Value (kn): _____ Max. Value ON

Calibration Cal. Table ON

Calibration Table								
Cal. No.	Uncal. Sp	True Spd.	Cal. No.	Uncal. Sp	True Spd.	Cal. No.	Uncal. Sp	True Spd.
0			7			14		
1			8			15		
2			9			16		
3			10			17		
4			11			18		
5			12			19		
6			13			20		

**NAVIKNOT 350 E
Record of Calibration Trial Runs**

005003-0125-004/A; Jun 2007

Vessel: _____ Hull No.: _____

IMO No.: _____ Shipyard: _____

Service Station / Installer: _____ Date / Signature: _____

_____ / _____

Location of runs:

Remarks:

Run #:		engine RPM:			
	run parameters			computed values	
	elapsed time (s)	distance (NM)	heading (°)	avg. uncal. spd.	true water speed
Run A (or single run)					
Run B (return run)					
averaged values (cal. table entry)					

Run #:		engine RPM:			
	run parameters			computed values	
	elapsed time (s)	distance (NM)	heading (°)	avg. uncal. spd.	true water speed
Run A (or single run)					
Run B (return run)					
averaged values (cal. table entry)					

Run #:		engine RPM:			
	run parameters			computed values	
	elapsed time (s)	distance (NM)	heading (°)	avg. uncal. spd.	true water speed
Run A (or single run)					
Run B (return run)					
averaged values (cal. table entry)					

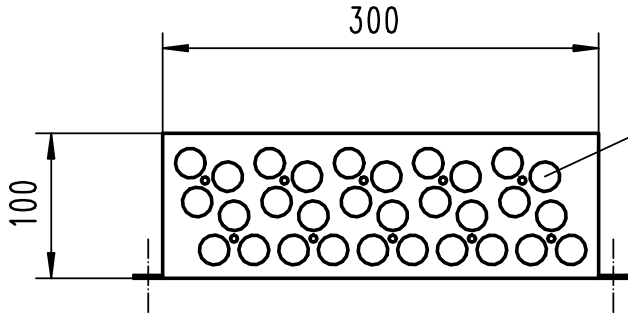

Ø20,5 (30*)

Schirmgeflecht über den Kabelmantel gezogen und mit Schellen oder Kabelbindern befestigt.

Draw the screen back over the outer cable cover and attach it to the unit with clamps or cable bands.

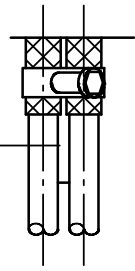
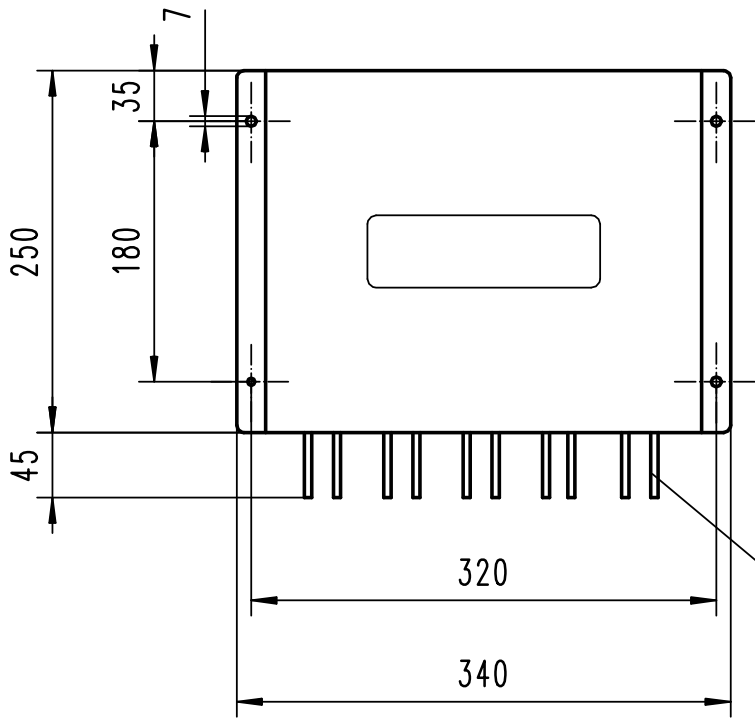

Gewicht/Weight : 4 kg
 Schutzart/Protection grade : IP 23

© (NORTHROP GRUMMAN SPERRY MARINE 06.12.2006)

				NORTHROP GRUMMAN		DATE		NAME		DIMENSION DRAWING		SCALE	
				Sperry Marine		DRAWN 06.12.2006		Ho.		Electronics Unit		/	
				HAMBURG GERMANY		CHD		see ECO					
						DOS		5003-0112-01					
				DRAWING No.								SHEET	
B	982016	15.03.07	Ho.	5003-0112-01								1	
A	981992	27.02.07	Ho.			FIRST ANGLE PROJECTION		DIMENSIONS IN MILLIMETERS				SHEETS	
0	-	06.12.06	Ho.									1	
REV	ECO-No.	DATE	NAME	STOCK No. 73510		REPLACEMENT FOR:		FREE SCALE:		DIN ISO 2768 mH			

Kabellänge 3,2m
Length of cable

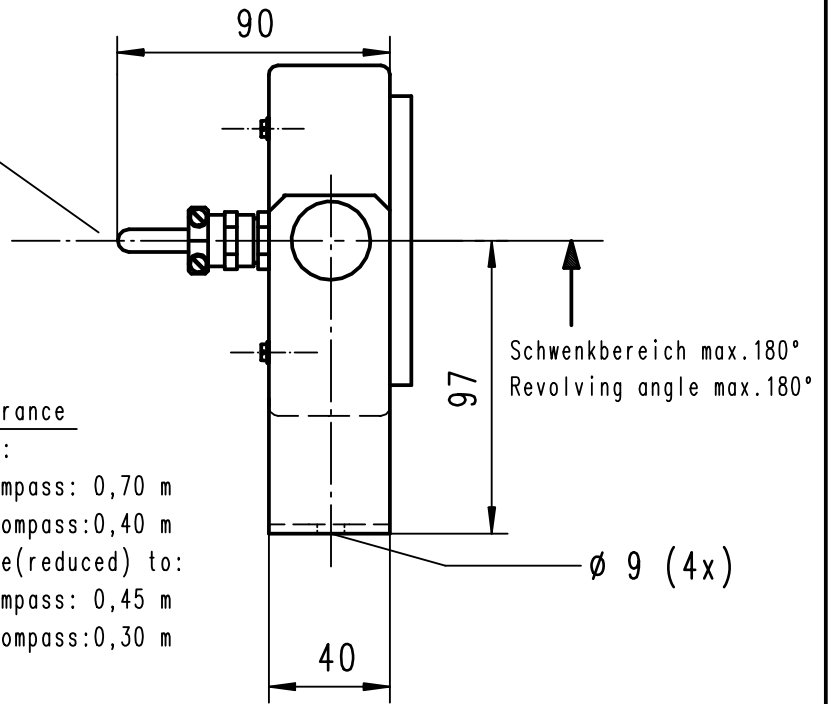

Magnetischer Schutzabstand/Magnetic Clearance

Mindestabstand vom:/Minimum Clearance to:

Magnet-Regelkompaß/Standard Magnetic Compass: 0,70 m

Magnet-Steuerkompaß/Steering Magnetic Compass: 0,40 m

Reduz. Mindestabst. vom:/Minimum Clearance (reduced) to:

Magnet-Regelkompaß/Standard Magnetic Compass: 0,45 m

Magnet-Steuerkompaß/Steering Magnetic Compass: 0,30 m

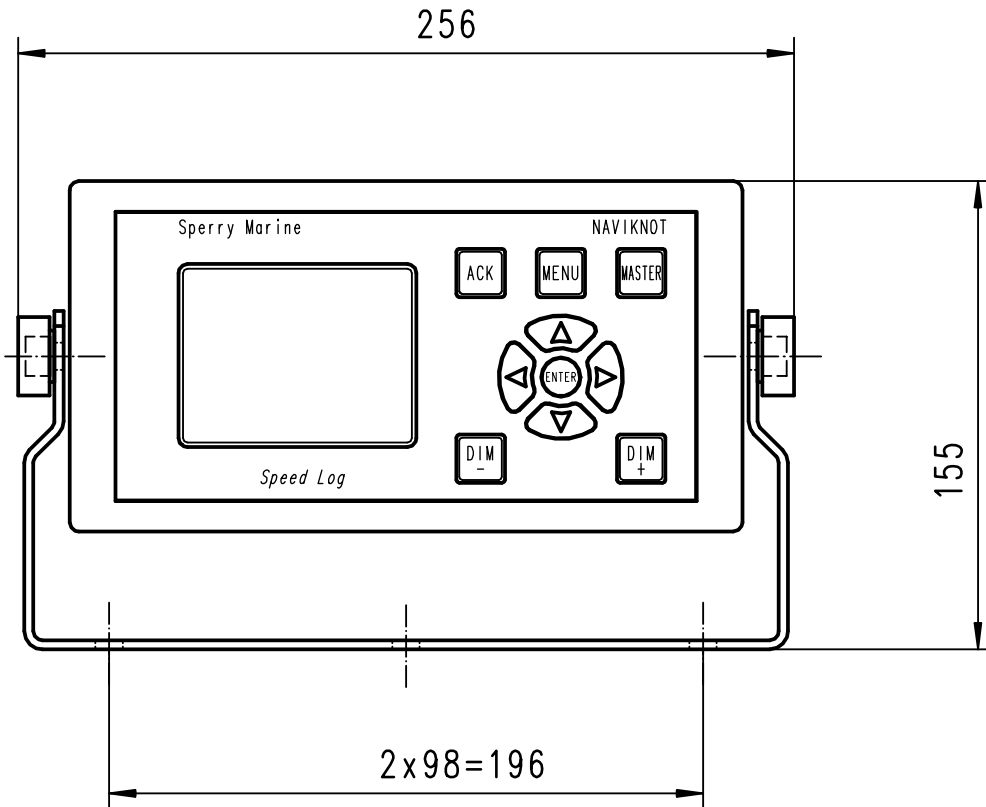

Gewicht/Weight: 3,2 kg

Abstand der Befestigungsbohrungen.

Distance between fixing holes.

© (NORTHROP GRUMMAN SPERRY MARINE 20.02.2007)

				NORTHROP GRUMMAN	DATE	NAME	DIMENSION DRAWING	SCALE				
				Sperry Marine	DRAWN	20.02.2007 Ho.			NAVIKNOT 350/450 Control and Display Unit	/		
				HAMBURG GERMANY	CHD	see ECO					Bedien- und Anzeigeeinheit im Gehäuse mit Bügel. Control and display unit with housing and brackets.	SHEET
					DOS	5001-0112-01						
				DRAWING No.			REPLACEMENT FOR:	FREE SCALE: DIN ISO 2768 mH				
				5001-0112-01					1			
A	982006	06.03.07	Hinr	FIRST ANGLE PROJECTION	DIMENSIONS IN MILLIMETERS							
0	-	27.11.05	Ho.									
REV	ECO-No.	DATE	NAME	STOCK No. 73507								

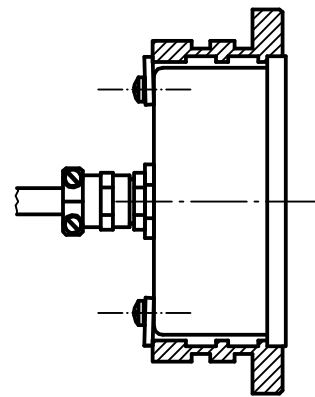
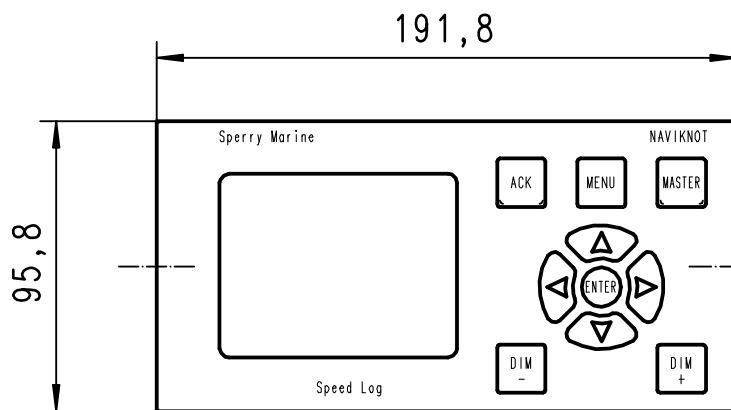

Kabellänge 3,2m
Length of cable

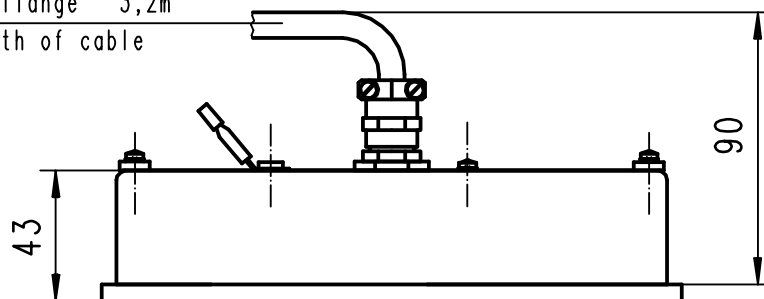

Einbau in Pultrahmen INSTALLATION IN CONSOLE FRAME

Magnetischer Schutzabstand/Magnetic Clearance

Mindestabstand vom:/Minimum Clearance to:

Magnet-Regelkompaß/Standard Magnetic Compass: 0,70 m

Magnet-Steuerkompaß/Steering Magnetic Compass: 0,40 m

Reduz. Mindestabst. vom:/Minimum Clearance (reduced) to:

Magnet-Regelkompaß/Standard Magnetic Compass: 0,45 m

Magnet-Steuerkompaß/Steering Magnetic Compass: 0,30 m

* = Montagesatz 22724
INSTALLATION KIT 22724

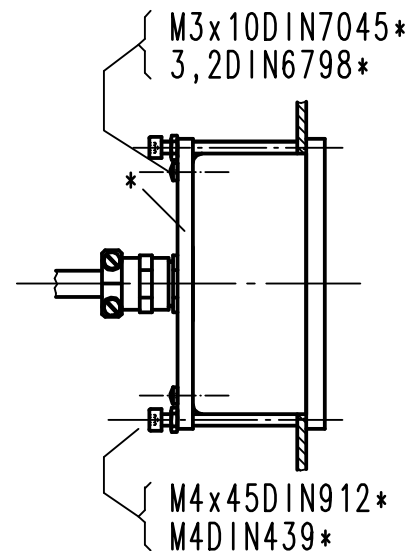
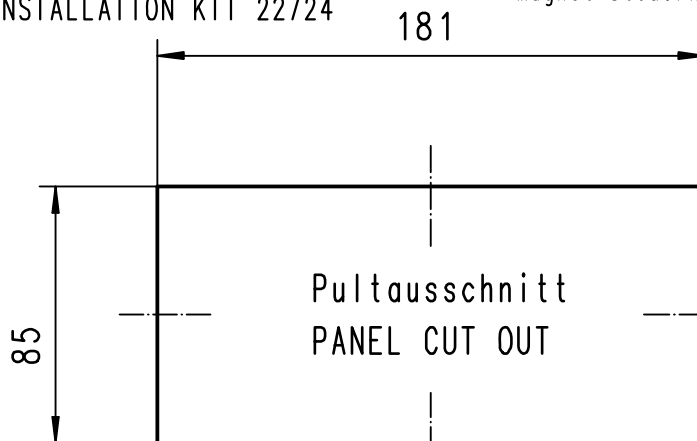

Pulteinbau PANEL INSTALLATION

Gewicht/Weight: 2,4 kg

REV	ECO-No.	DATE	NAME	STOCK No.	DATE	NAME	DIMENSION DRAWING	SCALE
							NAVIKNOT 350/450 Control and Display Unit Frontseitig wasserdicht IP 65 Watertight front IP 65	/ SHEET 1 SHEETS 1
			NORTHROP GRUMMAN					
			Sperry Marine	DRAWN	27.11.2006	Ho.		
			HAMBURG GERMANY	CHD		see ECO		
				DOS	5001-0112-02			
				DRAWING No.	5001-0112-02			
A1	982028	27.03.07	Ho.					
A	982006	06.03.07	Hinr					
0	-	27.11.06	Ho.					
							REPLACEMENT FOR:	FREE SCALE: DIN ISO 2768 mH

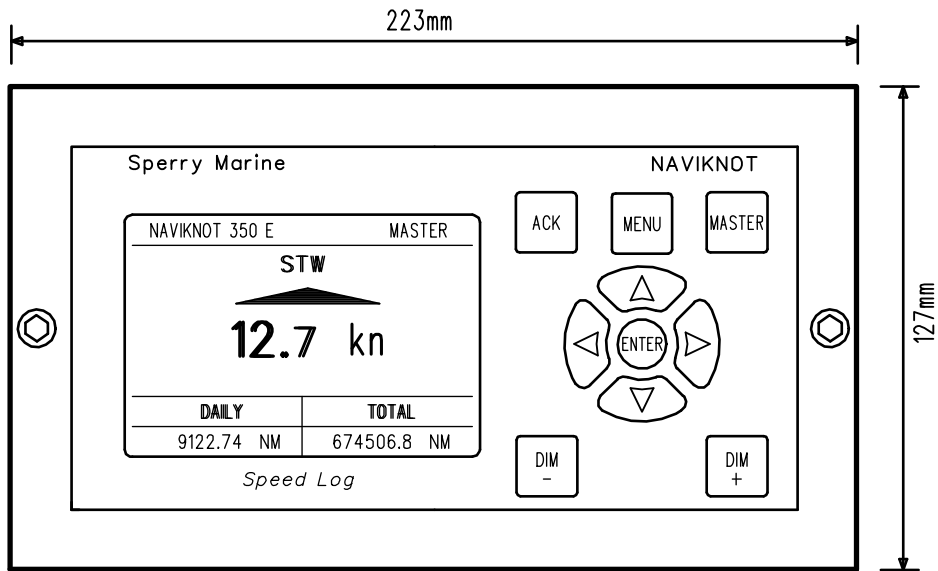

Depth: 150mm

				<i>NORTHROP GRUMMAN</i>		Date	Name	TITLE Ansicht Pultplatte CONSOLE FRAME LAYOUT	
				Sperry Marine	DRAWN	13.03.2007	Schütt		
				Hamburg Germany	DESIGN	13.03.2007	Reinecke		
				RAHMEN00\0021-0112-86S01	CHD ECO				
				Rahmen Lg-Nr. 39086				DRAWING No. 0021-0112-86	SHEET 1 SHEETS 1
A	981 901	13.03.07	Schütt	STOCK No. 79 488				© NORTHROP GRUMMAN SPERRY MARINE 13.03.2007 Each modification of this drawing requires the approval from NORTHROP GRUMMAN SPERRY MARINE HAMBURG in written form.	
REV	ECO-No.	DATE	NAME						

© (NORTHROP GRUMMAN SPERRY MARINE 10.02.1994)

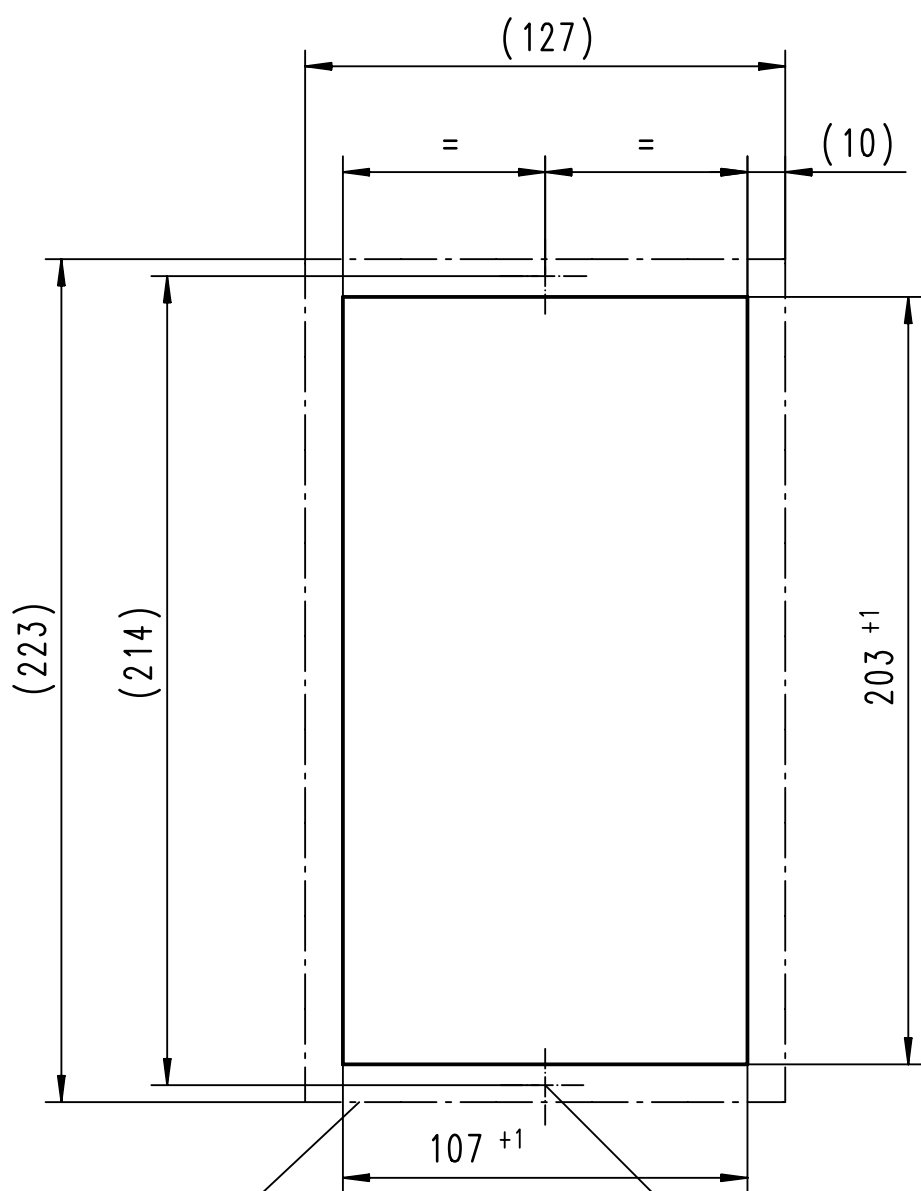

Platzbedarf für Rahmen
Space requirement for frame

M5 bei Montage vom Pultrahmen
abbohren und gewindeschneiden
Drilled off from console frame
and threaded M5

Pultplatte max. 20 mm dick
Thickness of panel max.20 mm

				<i>NORTHROP GRUMMAN</i>	DATE	NAME	DIMENSION DRAWING Pultausschnitt Console cut out 1 * 2	SCALE
				Sperry Marine	DRAWN 10.02.1994	Ho.		/
				HAMBURG GERMANY	CHD see ECO			
					DOS 0012-0112-02			
				DRAWING No. 0012-0112-02				SHEET
AC	98351	20.04.01	Ho.	FIRST ANGLE PROJECTION DIMENSIONS IN MILLIMETERS			1	
AB	99669	10.07.96	Ho.				1	
AA	99224	15.02.94	Ho.	STOCK No.			SHEETS	
REV	ECO-No.	DATE	NAME	REPLACEMENT FOR: Ausgabe 00A			FREE SCALE: DIN ISO 2768 mH	1

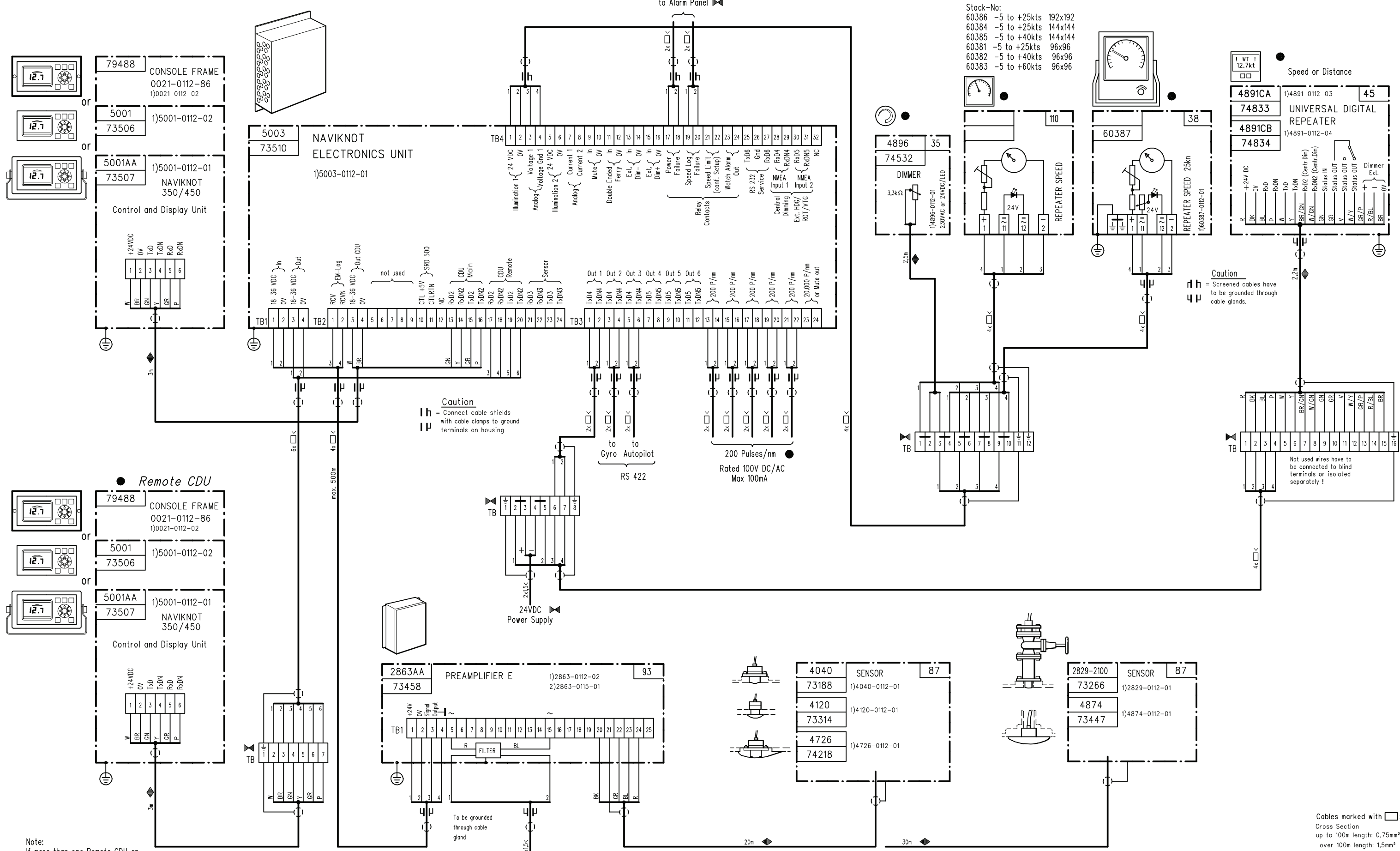

Stock-No:

60386	-5 to +25kts	192x192
60384	-5 to +25kts	144x144
60385	-5 to +40kts	144x144
60381	-5 to +25kts	96x96
60382	-5 to +40kts	96x96
60383	-5 to +60kts	96x96

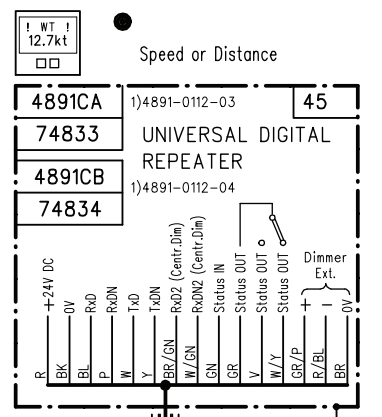

Caution
 4h = Screened cables have to be grounded through cable glands.

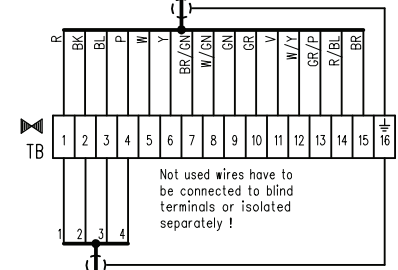

Caution
 4h = Connect cable shields with cable clamps to ground terminals on housing

to Gyro Autopilot
 to RS 422

200 Pulses/nm
 Rated 100V DC/AC
 Max 100mA

Note:
 If more than one Remote CDU an additional Power Supply is required!

Caution
 All Power Supplies must be separately fused!
 All Housings must be grounded!
 If screened cables are not grounded as shown, malfunction will occur!

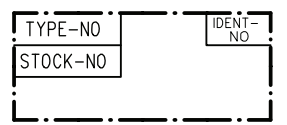

REMARKS
 1) Dimension Drawing
 2) Wiring Diagram
 ● if required
 < Screened Cable
 all cables marked with letters are Sperry Marine Supply of max. 3m length
 (AA)

General Notes:

- All cables shipyard supplied unless otherwise specified
- Components Owner- or Yard-Delivery
- Cables delivered by Sperry Marine
- All cables to be screened, unless otherwise specified
- All units unless otherwise specified to be directly connected to ship's earth
- Cable diameters acc. to classification requirements unless otherwise stated
- All cables to include a min 1/10 of unused conductors

DESCRIPTION	REV	ECO-No.	DATE	NAME
	A	981 900	04.04.07	Geisler

Date	Name	TITLE
04.04.2007	Geisler	ELECTROMAGNETIC LOG NAVIKNOT 350 E
04.04.2007	Dietmann	
21.06.2007	Steiger	

5001/5001-0153-11S01

CHD ECO

NORTHROP GRUMMAN
 Sperry Marine
 Hamburg Germany

DRAWING No.	SHEET
5001-0153-11/A	1

© NORTHROP GRUMMAN SPERRY MARINE 04.04.2007
 Each modification of this drawing requires the approval from NORTHROP GRUMMAN SPERRY MARINE HAMBURG in written form.

Cables marked with □ :
 Cross Section
 up to 100m length: 0,75mm²
 over 100m length: 1,5mm²

